



EPISODE: 202B JOHNNY MINT CHIP

STORYBOARDED BY: J. Knott & Derek Jessome

STATUS: LOCKED ANIMATIC

DATE: Aug 9 2006

NOTES:



© 2006 Johnny Test Productions Inc. "Johnny Test" TM Warner Bros. Entertainment Inc. All Rights Reserved.

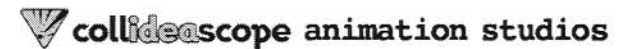



⊕ PAGE # 1A NEXT!

PAGE: 1

(R3-VIS
-PANEL # 5
-SC #

(R3-VIS

SCENE ①

PANEL 1/3

BG

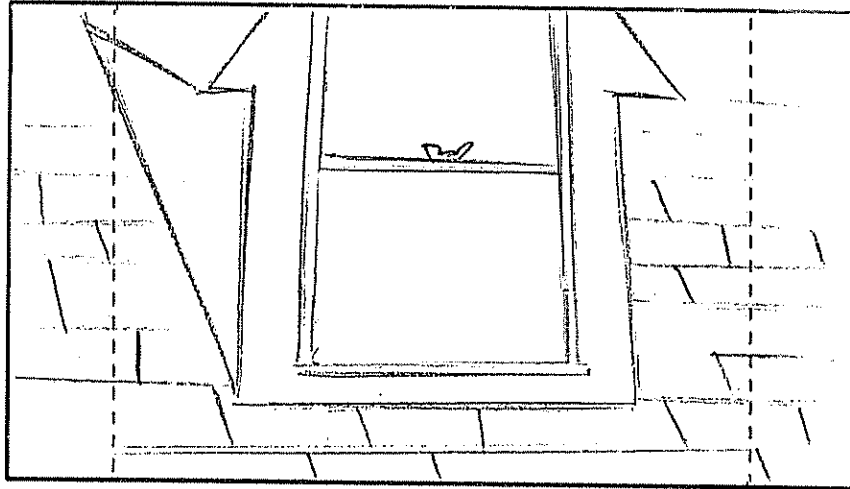

SCENE

PANEL 2/3

BG

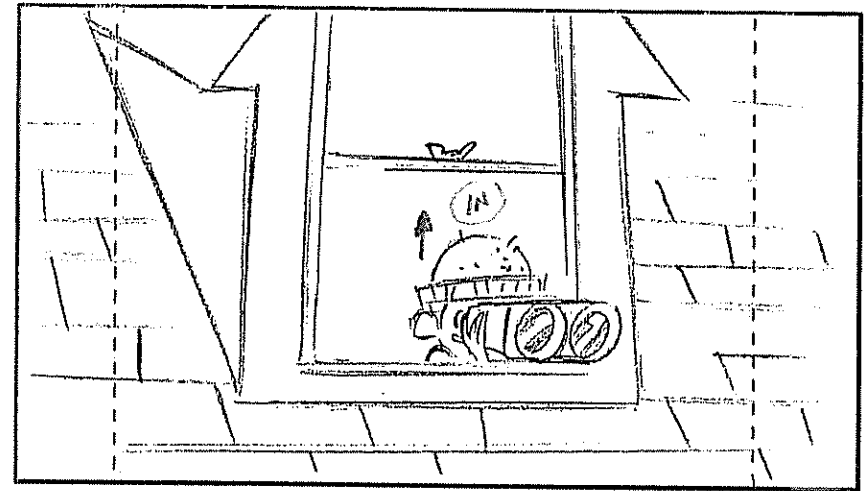

ACTION

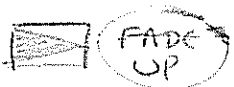

EXT - TEST HOUSE, JOHNNY'S WINDOW, DAY.

- JOHNNY POPS UP INTO SC. LOOKING OUT OF BINOCULARS. IN SPY COSTUME.

DIALOGUE

NOTES





⊕ PAGE # 1B NEXT!

PAGE: 1A

123 - SC #
- PANEL # 15.

SCENE 1 CONT'D PANEL 3/3 BG

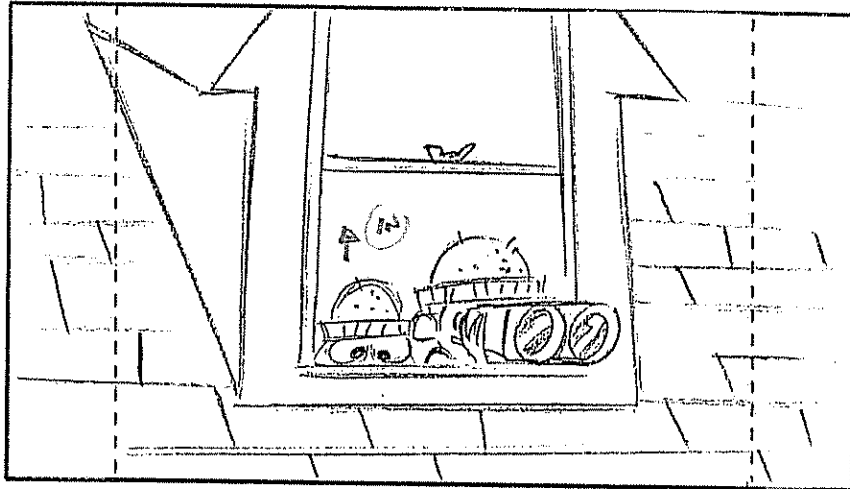

ACTION

- DUCKY INTO SC. IN DISGUISE.

SCENE (2) PANEL 1/2 BG

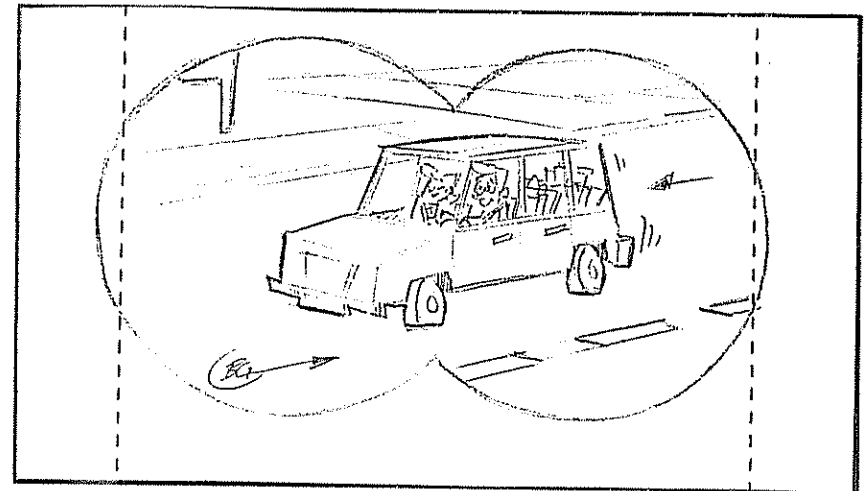

CUT TO VIEW THROUGH BINOCULARS OF TEST CAR
DIAG-PAN OF 1B.

DIALOGUE

JOHNNY: (P.U.)

TARGET IDENTIFIED.

JOHNNY: (CONT'OS.)

FABULOUS FROZEN TREAT SUBJECTS
APPROACHING...

NOTES



(R3) - VIS.

SCENE 2 CONT'D

PANEL

2/2

BG

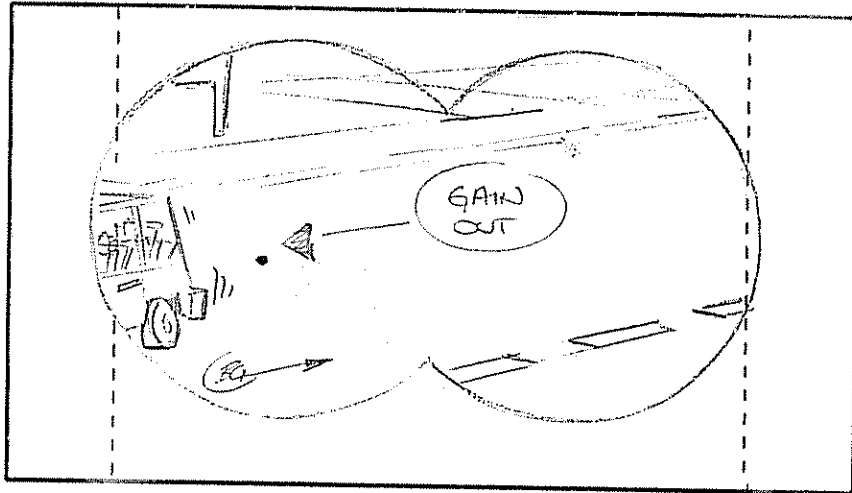

ACTION

SCENE

PANEL

BG

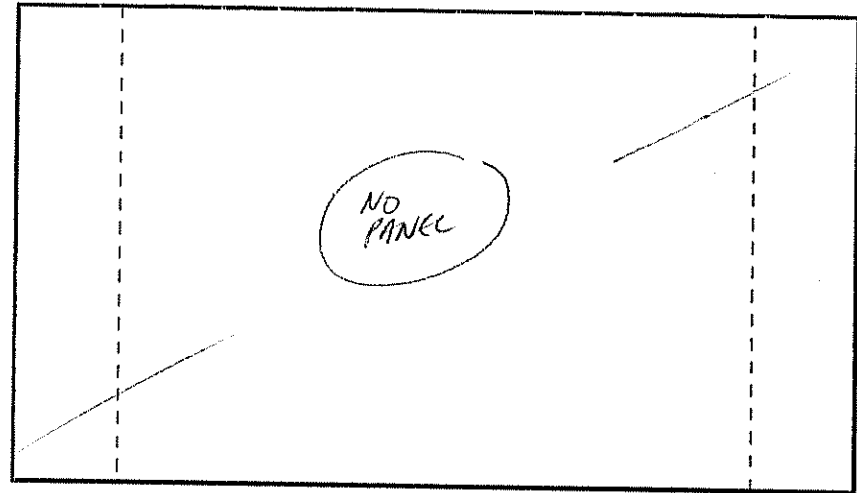

DIALOGUE

NOTES

2028

⊕ PAGE # 3A NEXT!



EPISODE: _____ | PAGE: 2

(R2) - VIS

(E) - VIS

SCENE

BG

SCENE (3)

BG

Panel cut

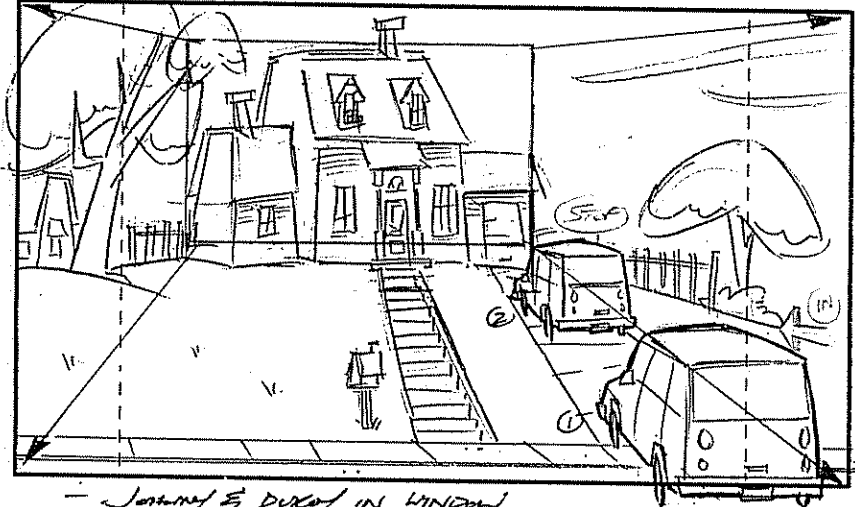

- JOHNNY & DAD IN WINDOW
- ~~TRE~~ CUT AS MOM & DAD'S CAR ENTERS (1) & STAIRS (E)

(W)

DIALOGUE

NOTES



© 2006 Johnny Test Productions Inc "Johnny Test" TM Warner Bros Entertainment Inc. All Rights Reserved.

collidescope animation studios

(R2)



2023

PAGE: 2A

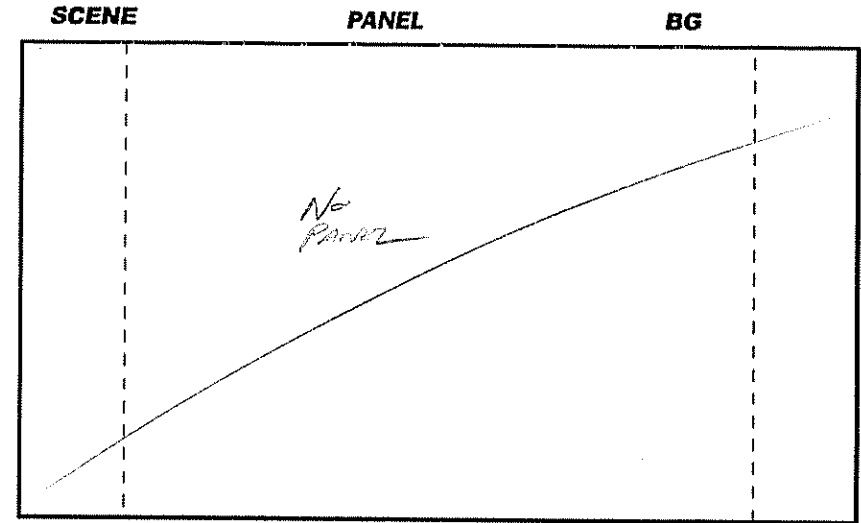
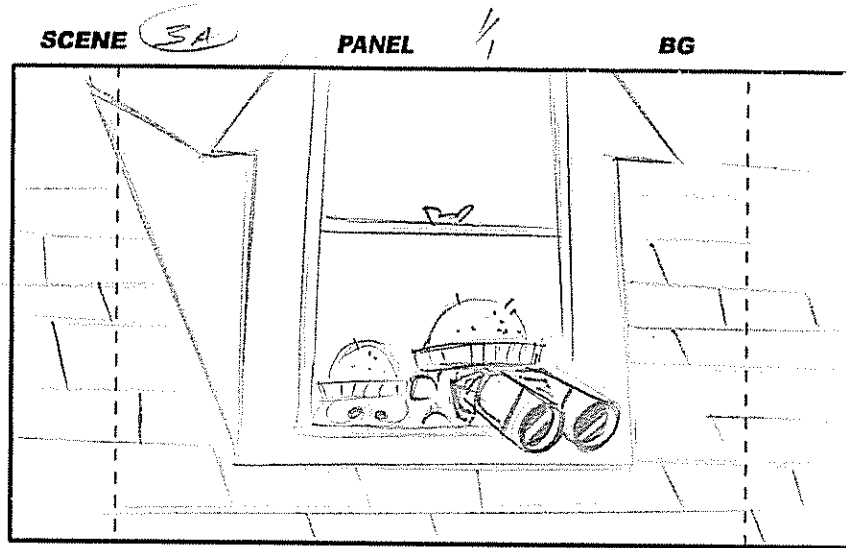

ACTION

CS

DIALOGUE

NOTES



2026



EPISODE: _____

PAGE: 003

(R2)-VIS

SCENE (004)

1/2

BG

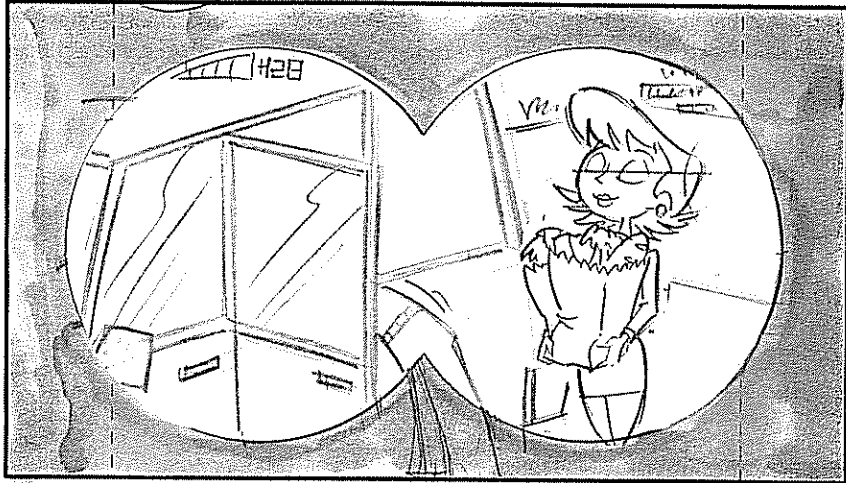

SCENE

1/2

BG

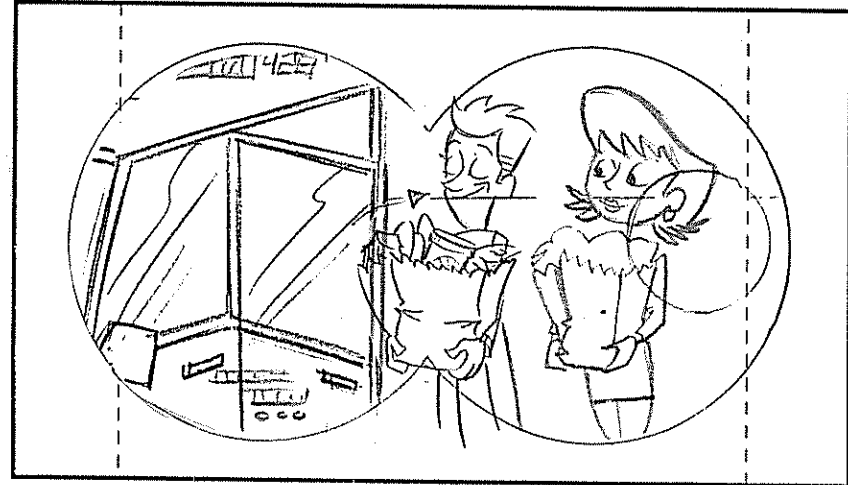

ACTION

(W)

- JOHNNY'S POV (BINOCULARS O/L)

- "SIGHTS" LINE UP ON DAD'S PACKAGE..

DIALOGUE

NOTES

- RED ON GREEN TRANSPARENT O/C



© 2006 Johnny Test Productions Inc "Johnny Test" TM Warner Bros Entertainment Inc. All Rights Reserved

collideoscope animation studios

(R2)

202B



EPISODE: _____

PAGE: 004

SCENE (4A)

BG

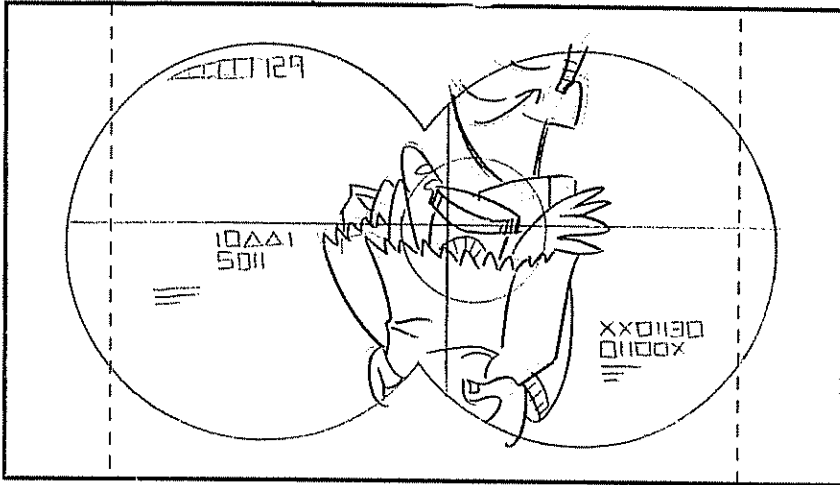

SCENE (4B)

BG

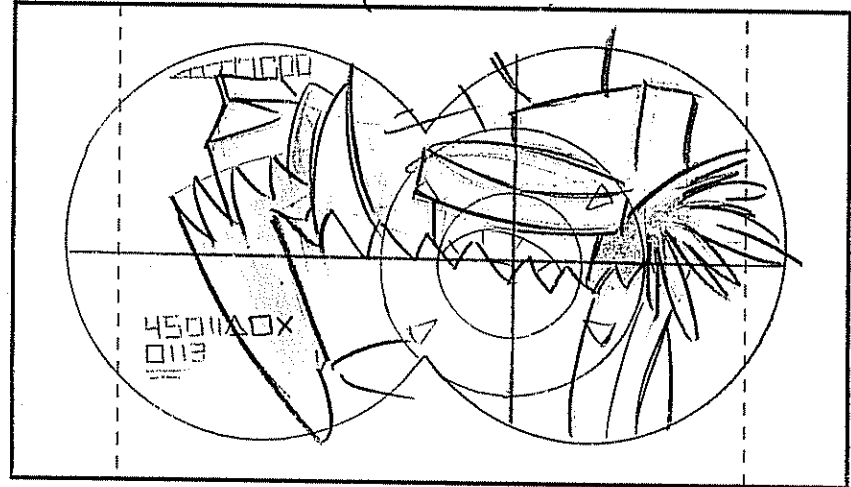

ACTION

(WA)

- CUT TO ~~_____~~
INCREASING CLOSE-UPS OF ~~_____~~
GROCERIES ...

(WT)

DIALOGUE

① JOHNNY: (O.S.)
MEGA MINT ...

JOHNNY: (CONT. O.S.)
... CHIP TARGET ...

NOTES



© 2006 Johnny Test Productions Inc. "Johnny Test" TM Warner Bros Entertainment Inc All Rights Reserved.

collideoscope animation studios

2023



EPISODE: _____

PAGE: 005

SCENE 4B CONT'D 2/2 BG

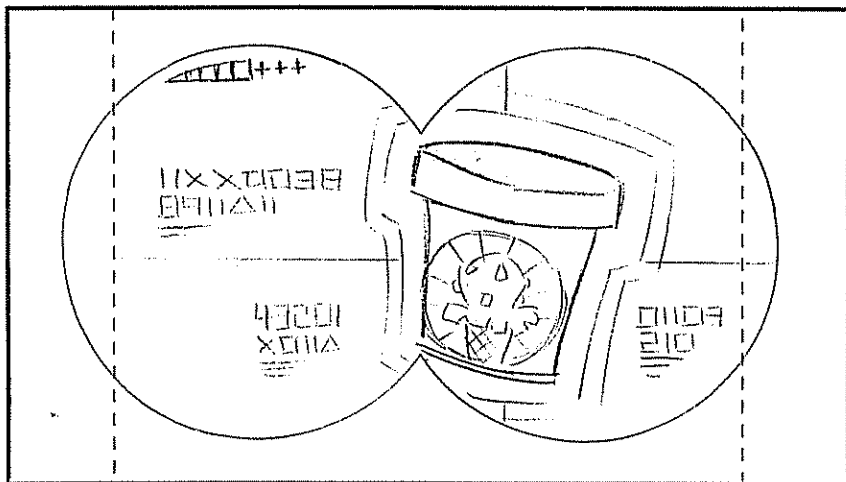

~~SCENE BG~~

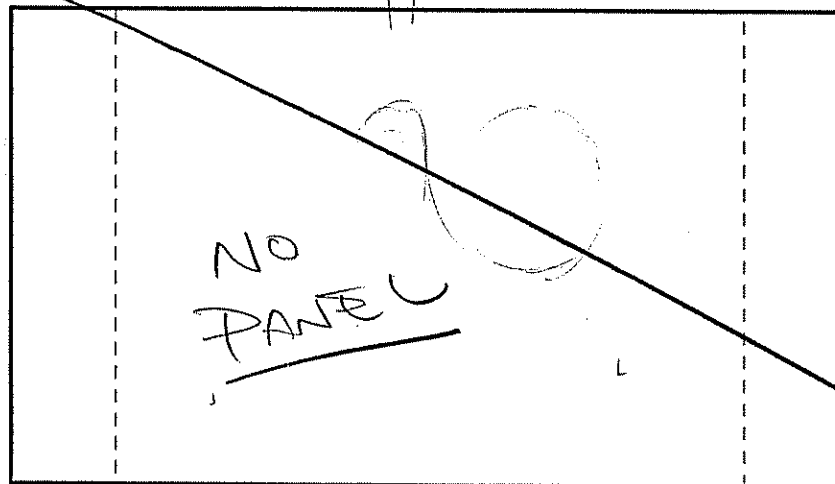

ACTION

- BINOCULARS "REVEAL"
ICE CREAM (TERMINATOR-ESQUE)

DIALOGUE

JOHNNY: (CONT'D S.)
... LOCKED!

NOTES



(R2) -VIS.

SCENE 5

PANEL 3/4

BG

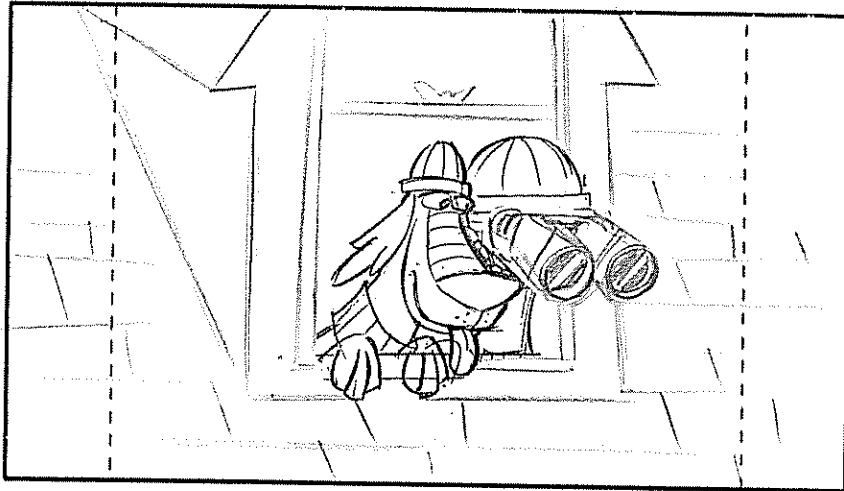

ACTION

W BACK TO DUCKY & JOHNNY AT WINDOW.

SCENE

PANEL 3/4

BG

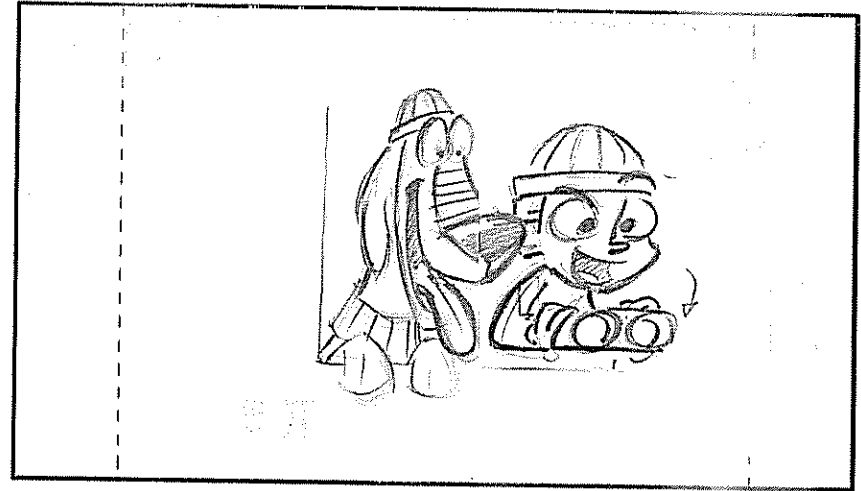

JOHNNY + DUCKY GET EXCITED.

DIALOGUE

NOTES

SCENE 5 CONT PANEL 3/4 BG

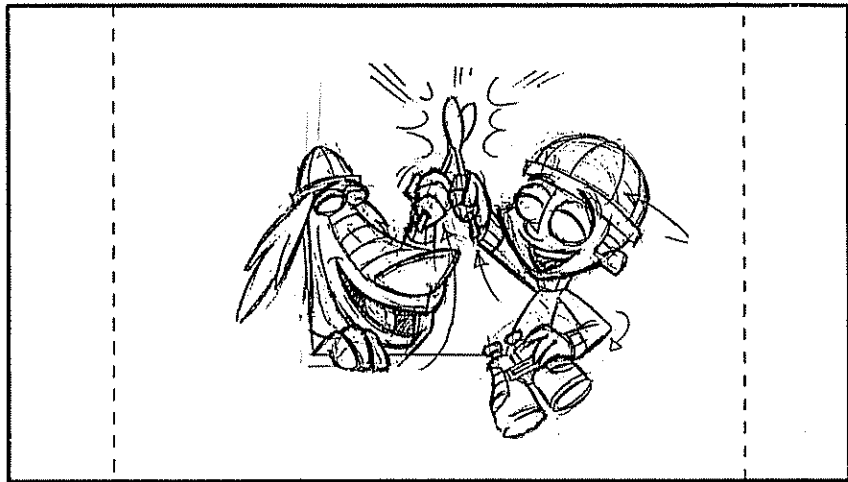

ACTION

THEY RAISE & SMACK SPOONS!

SCENE PANEL 4/4 BG

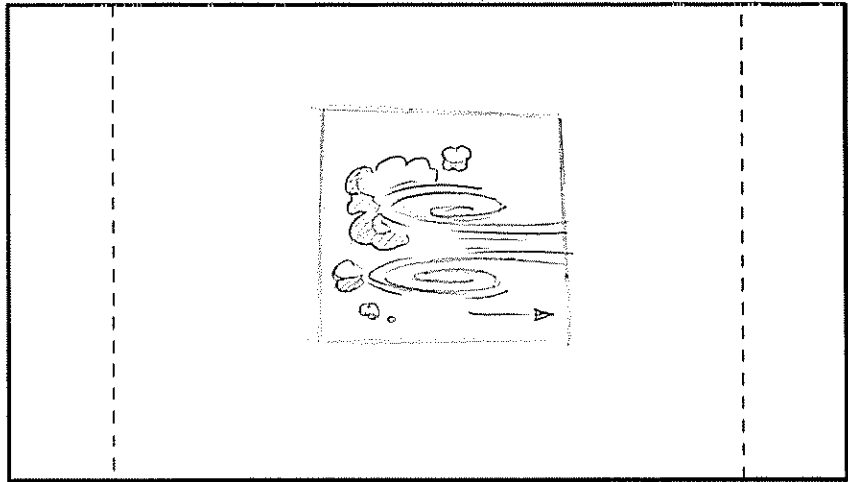

THEY BOTH ZIP OUT!

DIALOGUE

JOHNNY:
MOVE!

NOTES

202B



EPISODE: _____

PAGE: 007

Panel cut

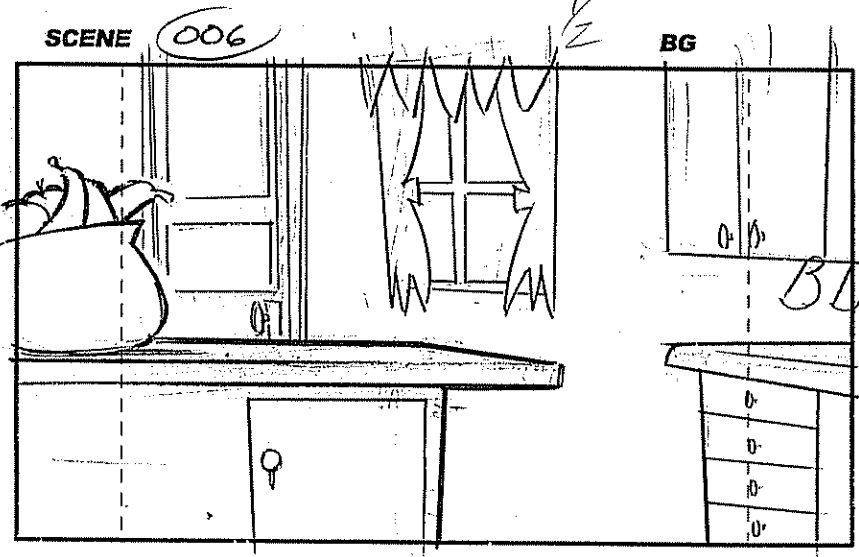

cut ~~_____~~ INT. KITCHEN

DIALOGUE

NOTES



© 2006 Johnny Test Productions Inc. "Johnny Test" TM Warner Bros. Entertainment Inc. All Rights Reserved

collideascope animation studios

2026



EPISODE: _____

PAGE: 008

SCENE 6

6

CONT'D

2/2

BG

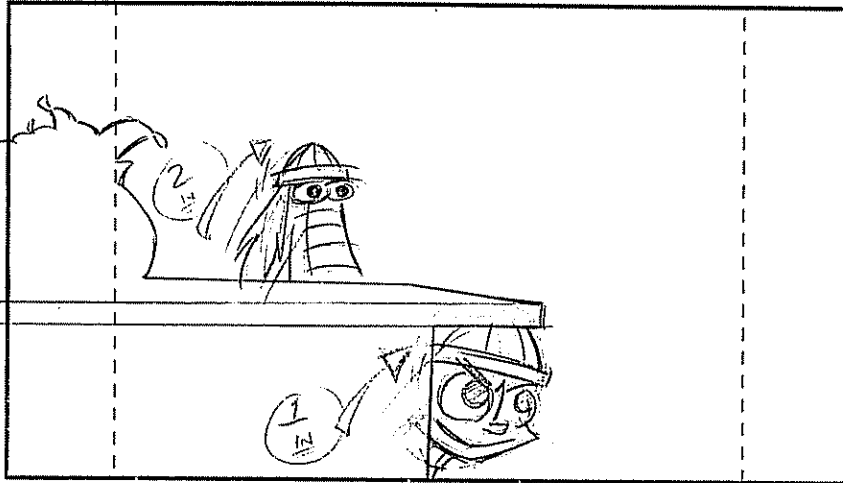

ACTION

J & D APPEAR BEHIND AN ISLAND..

SCENE 007

1/1

BG

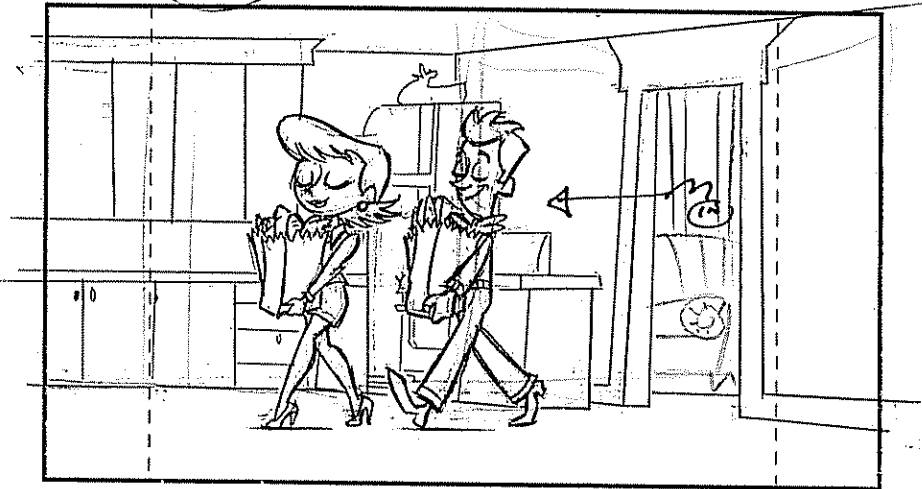

CUT

... MOM & DAD ENTER KITCHEN FROM LIVING ROOM.

DIALOGUE

NOTES



© 2006 Johnny Test Productions Inc "Johnny Test" TM Warner Bros. Entertainment Inc. All Rights Reserved

collideoscope animation studios

2003



EPISODE: _____

PAGE: 009

SCENE 008

1/4

BG

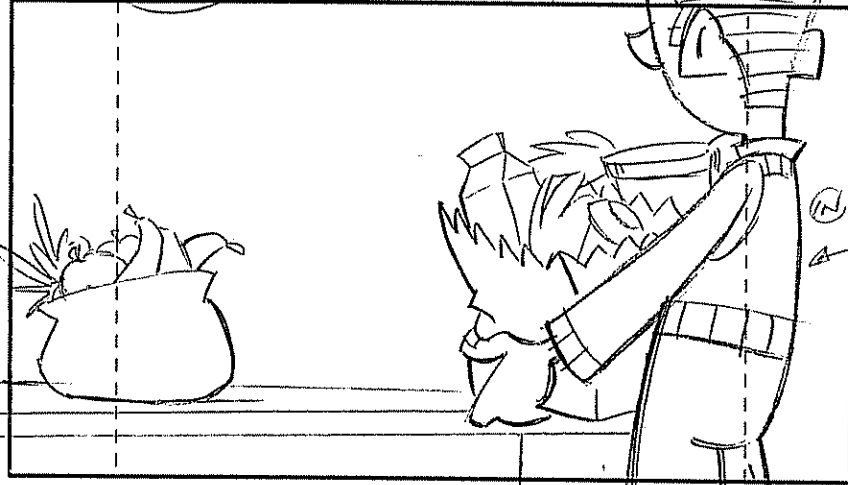

SCENE

2/4

BG

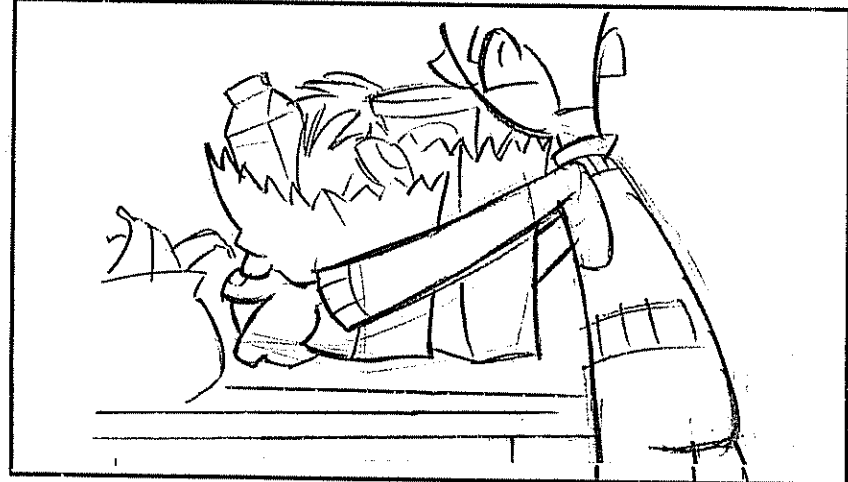

ACTION

CR DAD in!

- DAD PLACES GROCERIES UPON ISLAND -

DIALOGUE

NOTES * LAYOUT: EXTEND BG (FROM SC # 006)



© 2006 Johnny Test Productions Inc "Johnny Test" TM Warner Bros Entertainment Inc. All Rights Reserved

collidescope animation studios



202-13

EPISODE: _____

PAGE: 010

SCENE 8 CONT'D

3/4

BG

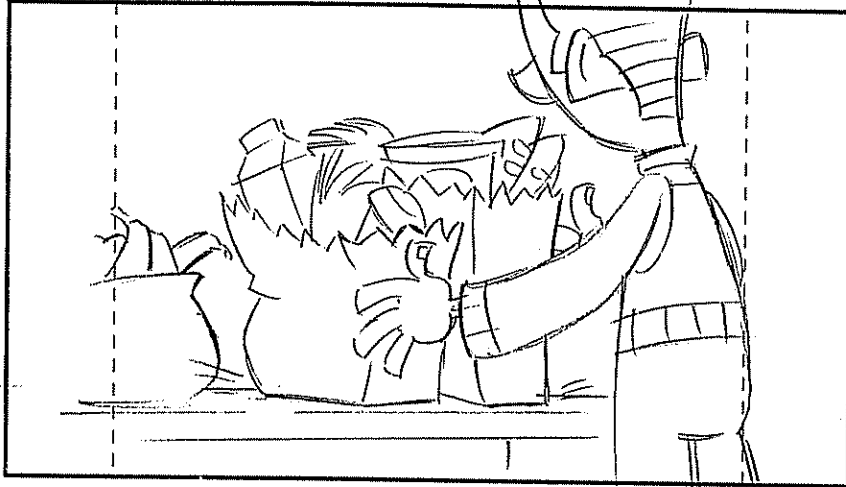

ACTION

SCENE

4/4

BG



DAD OUT.

DIALOGUE

NOTES



© 2006 Johnny Test Productions Inc. "Johnny Test" TM Warner Bros. Entertainment Inc. All Rights Reserved

collideascope animation studios

2023



EPISODE: _____

PAGE: 011

SCENE

009

1/3

BG



SCENE

2/3

BG

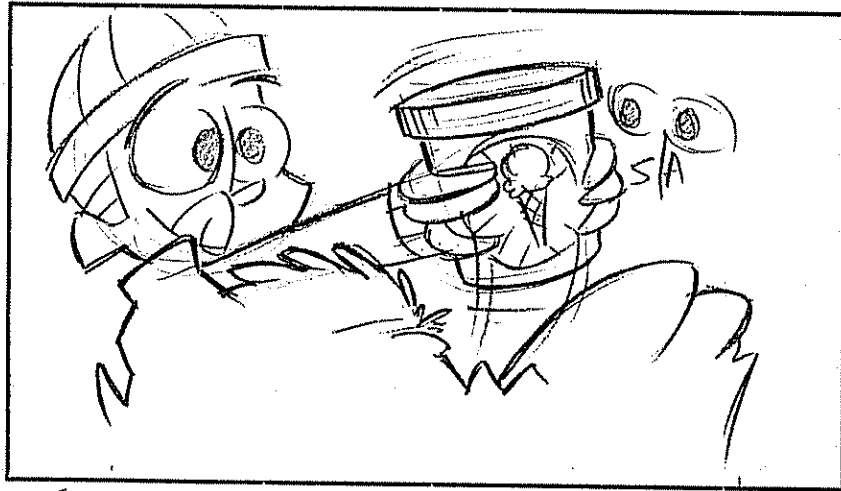

ACTION

JOHNNY & DUKEY (IN)
FROM BEHIND GROCERIES

JOHNNY GRABS THE ICE CREAM

DIALOGUE

NOTES



© 2006 Johnny Test Productions Inc. "Johnny Test" TM Warner Bros Entertainment Inc All Rights Reserved

collideoscope animation studios



2023

EPISODE: _____ | PAGE: 012

SCENE 9 CONT'D 3/3 BG

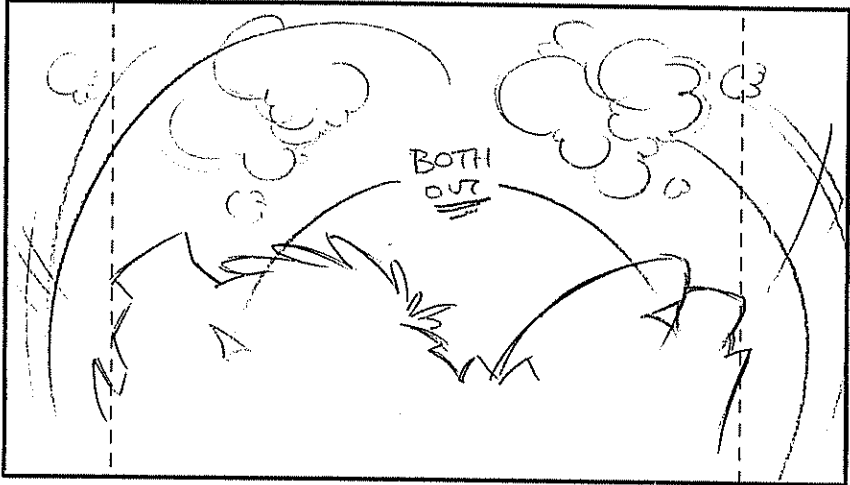

ACTION

AND BOTH DUCK OUT OF FRAME..

SCENE 010 1/1 BG

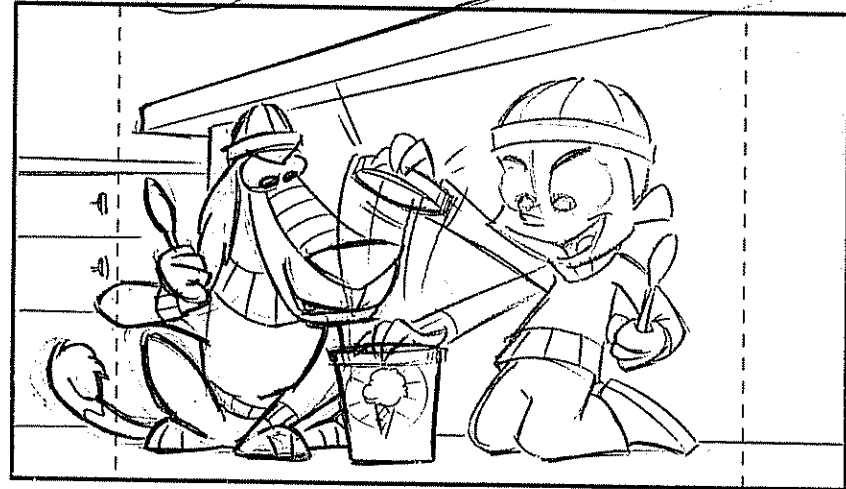

JOHNNY OPENS THE JAR..

DIALOGUE

2. JOHNNY/DUKEY
Eat!

NOTES



© 2006 Johnny Test Productions Inc. "Johnny Test" TM Warner Bros. Entertainment Inc. All Rights Reserved.

collidescope animation studios

202 B



SCENE (011)

BG

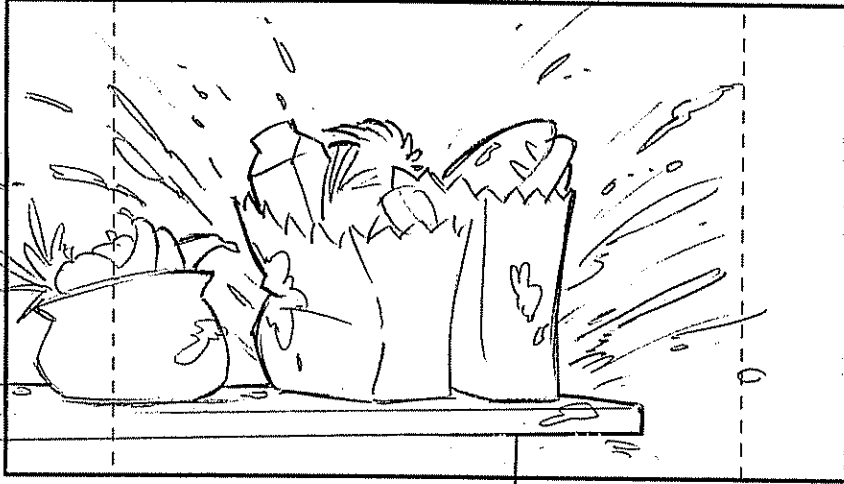

SCENE (012)

BG

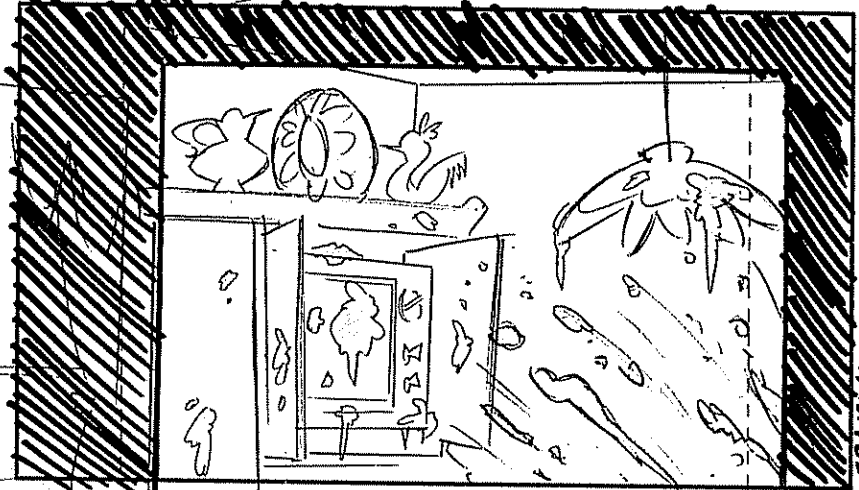

ACTION

(W)

- J & D CREATE A MESS -- ICE CREAM FLIES THROUGH THE KITCHEN..

DIALOGUE

NOTES





2026

EPISODE: _____

PAGE: 019

R2 - VIS
- ACT
- DIAL.

R3 - VIS

SCENE 013

BG

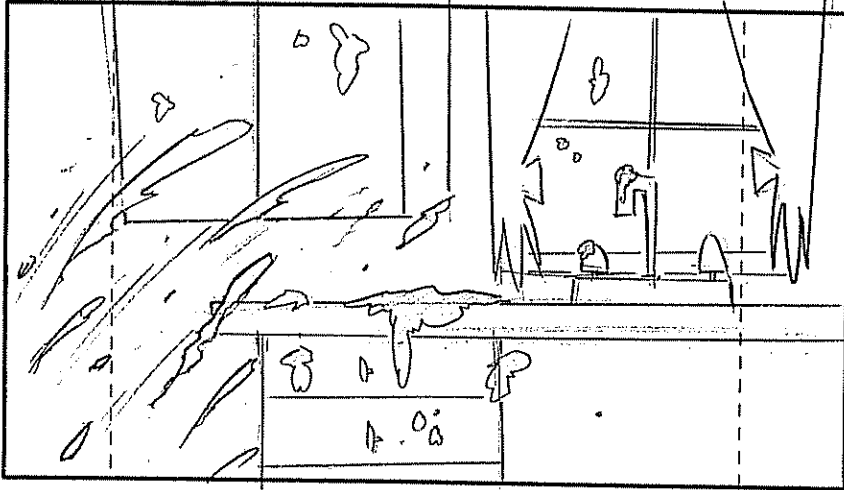

ACTION

(CUT) FOOD CONT. FLYING THROUGH KITCHEN

SCENE 014

BG



(CUT)

- Mom & DAD HAVE ENTERED THRU THE LIVING ROOM... DOOR..

DIALOGUE

DAD: (G.T.)
(WHISTLING) ~~~~~

NOTES



© 2006 Johnny Test Productions Inc "Johnny Test" TM Warner Bros Entertainment Inc All Rights Reserved

collidescope animation studios

R2 R3

202B



EPISODE: _____ PAGE: 015

SCENE

15

BG



SCENE

24

BG

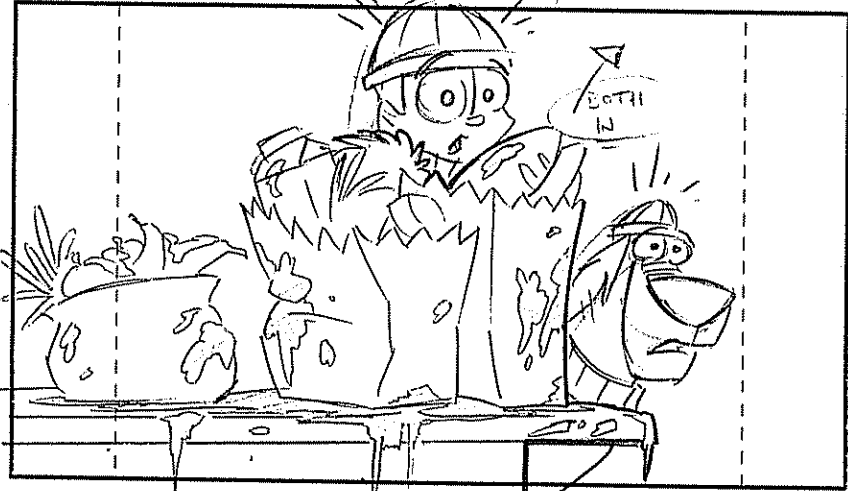

ACTION

TO MESSY GEOMETRY IN COUNTER

- Johnny & Duke IN

- J & D ARE CREATED BY THE DOOR-SLAM.

DIALOGUE

DAD: (o/s - GT)
(WHISTLING, CANTO)

NOTES



© 2006 Johnny Test Productions Inc "Johnny Test" TM Warner Bros Entertainment Inc. All Rights Reserved

collideoscope animation studios



202B

EPISODE: _____

PAGE: 016

SCENE 15 Cont'd

3/4

BG

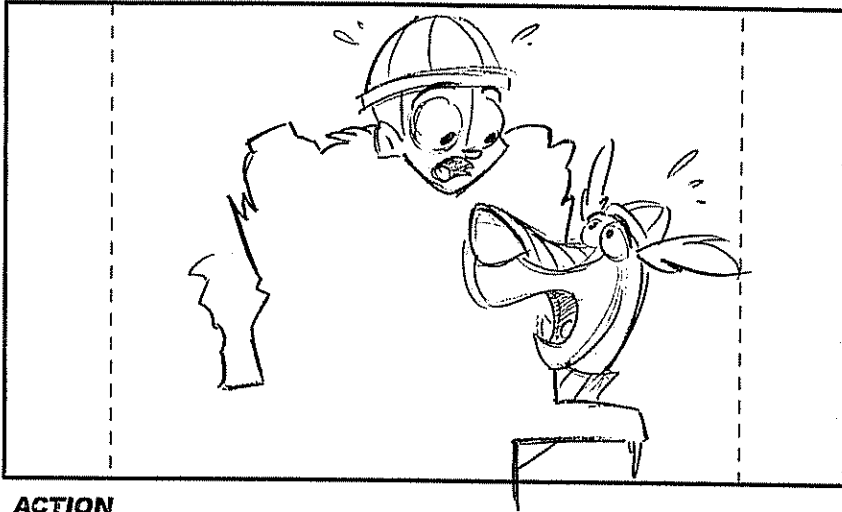

SCENE

4/4

BG

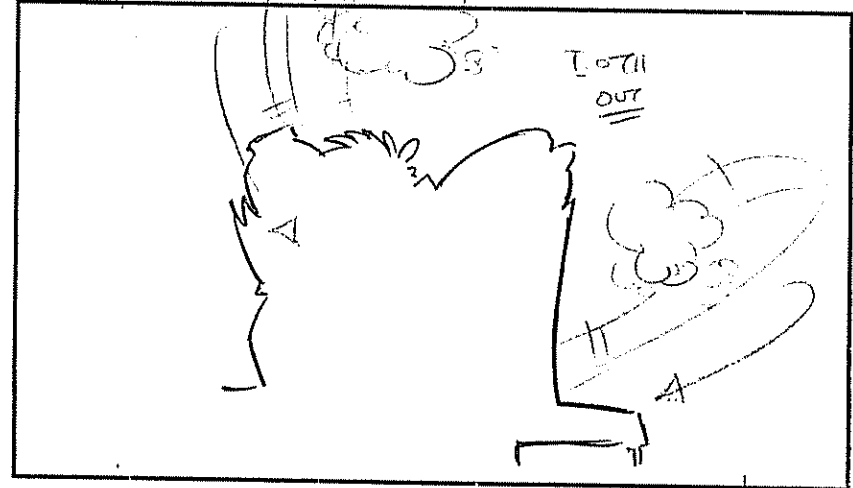

- THEY ESCAPE -

ACTION

DIALOGUE

Clean! 3. JOHNNY/DUKEY

NOTES



© 2006 Johnny Test Productions Inc "Johnny Test" TM Warner Bros. Entertainment Inc All Rights Reserved

collidescope animation studios

SCENE 016

⚡ BG

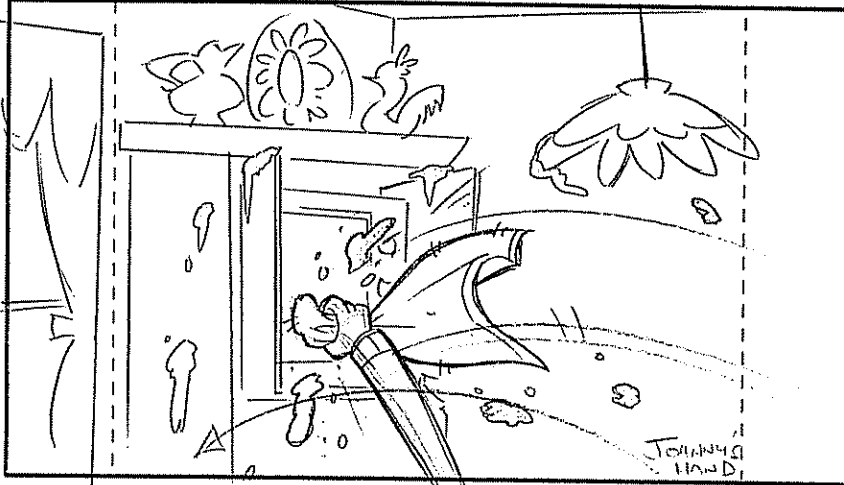

ACTION

ar

JOHNNY LIPES ..

THRU

SCENE 017

⚡ BG

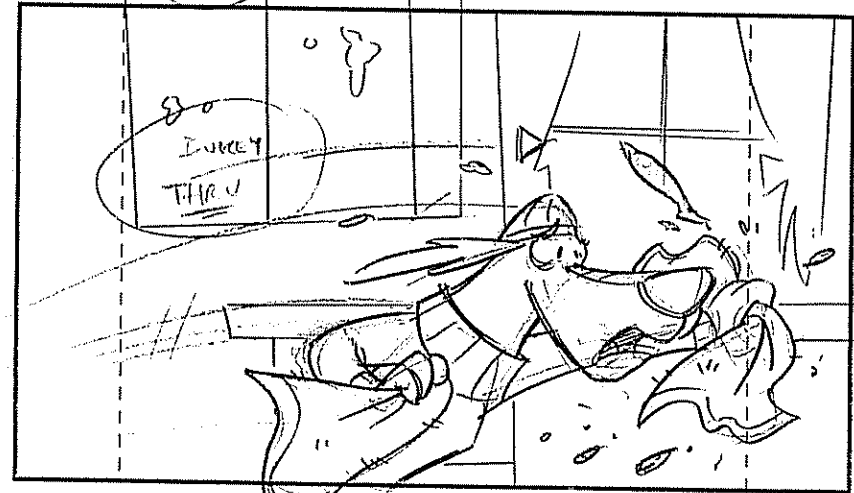

ar

- DUCKY THRU ..

DIALOGUE

NOTES



202B

EPISODE: _____ | PAGE: 018

SCENE (018)

1/2 BG

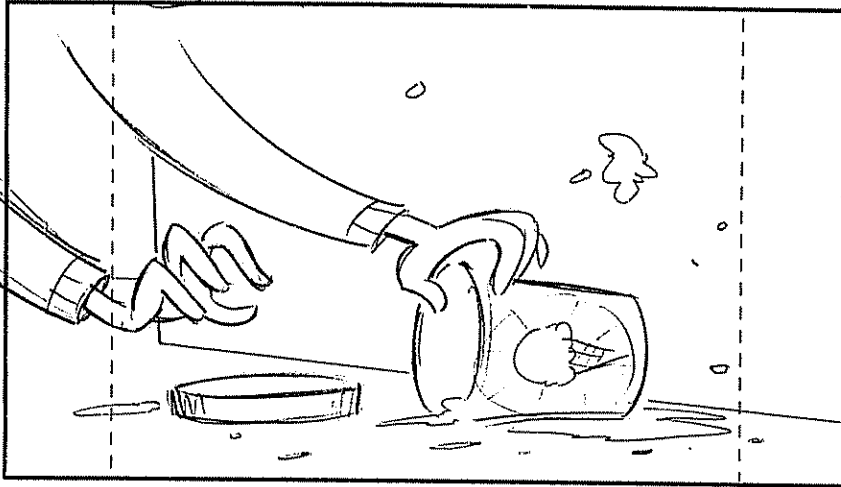

SCENE

2/2 BG

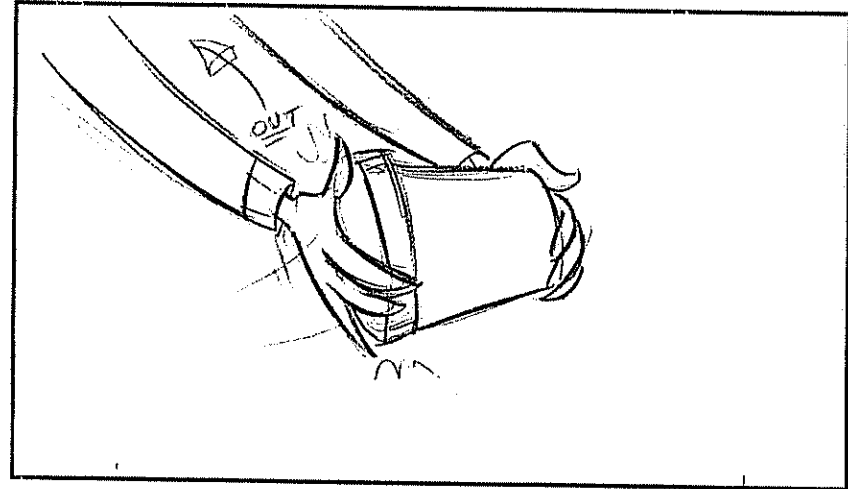

ACTION



CLOSE ON ICE CREAM TUB..

- JOHNNY CLOSES THE LID (OUT)..

DIALOGUE

NOTES



© 2006 Johnny Test Productions Inc "Johnny Test" TM Warner Bros Entertainment Inc. All Rights Reserved

collideoscope animation studios

SCENE (019)

1/5

BG



SCENE

2/5

BG

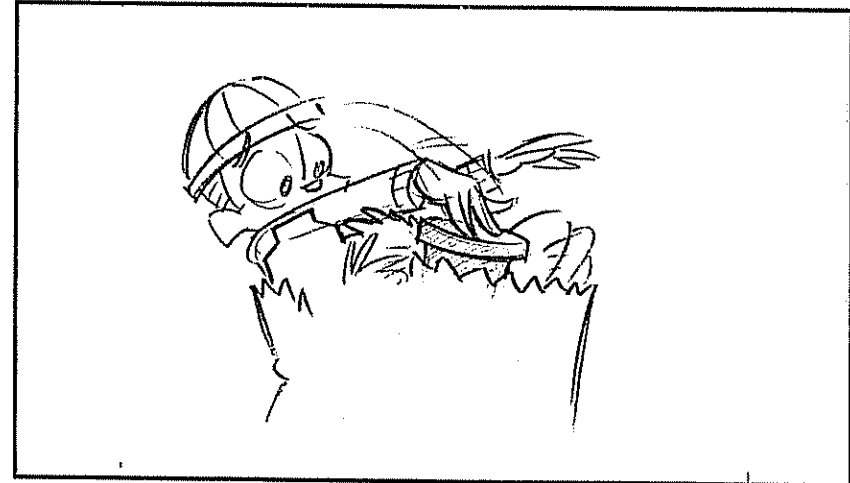

ACTION

(cut)

- JOHNNY REPLACES THE ICE CREAM -

DIALOGUE

NOTES



202B

⊕ PAGE # 20A NEXT!

EPISODE: _____

PAGE: 020

SCENE 19 *Cont'd*

3/5 BG

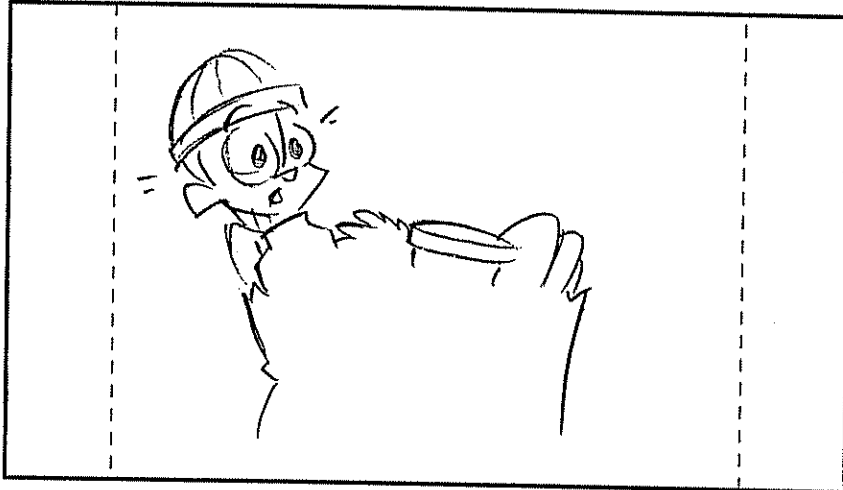

ACTION

SCENE

4/5 BG

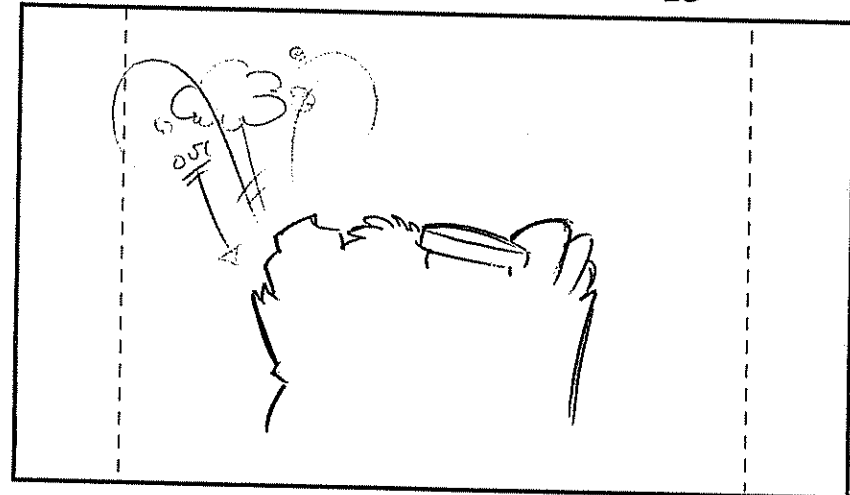

- AND ESCAPES

DIALOGUE

NOTES



© 2006 Johnny Test Productions Inc. "Johnny Test" TM Warner Bros. Entertainment Inc. All Rights Reserved

collideascope animation studios

SCENE 19 Cont'D PANEL

5/5

BG



ACTION

- DAD WALKS IN!

SCENE

PANEL

BG

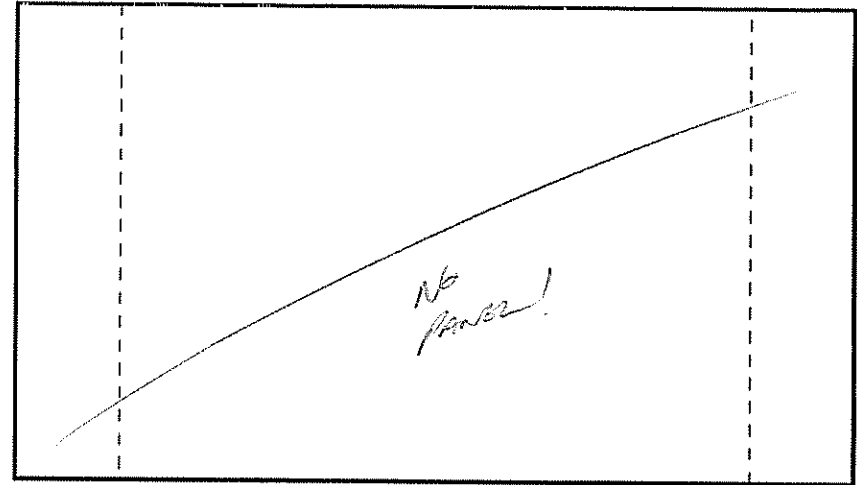

DIALOGUE

NOTES

SCENE (020)

BG

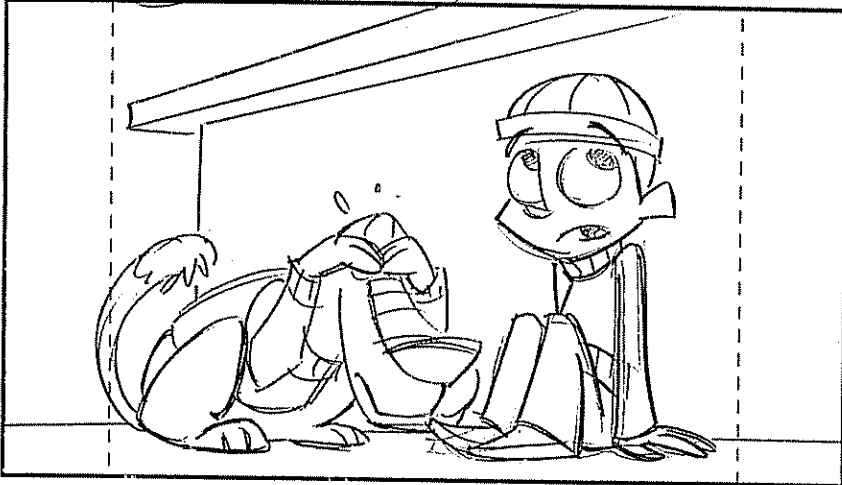

ACTION

CR

TO DUREY by Jeremy Hodner

SCENE (021)

BG

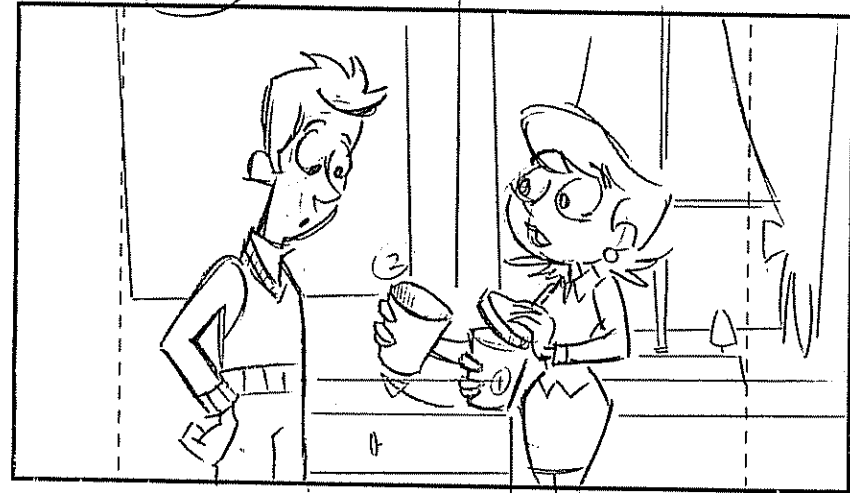

CR

DIALOGUE

4. MOM - (o/s)
Empty again?

(4) Mom - (cont'd)

THAT'S THE THIRD TIME THIS WEEK WE'VE BOUGHT ICE CREAM AND THE CONTAINER'S BEEN EMPTY.

NOTES





202B

(RZ) - DIAL

SCENE

21 Cont'd

2/2

BG

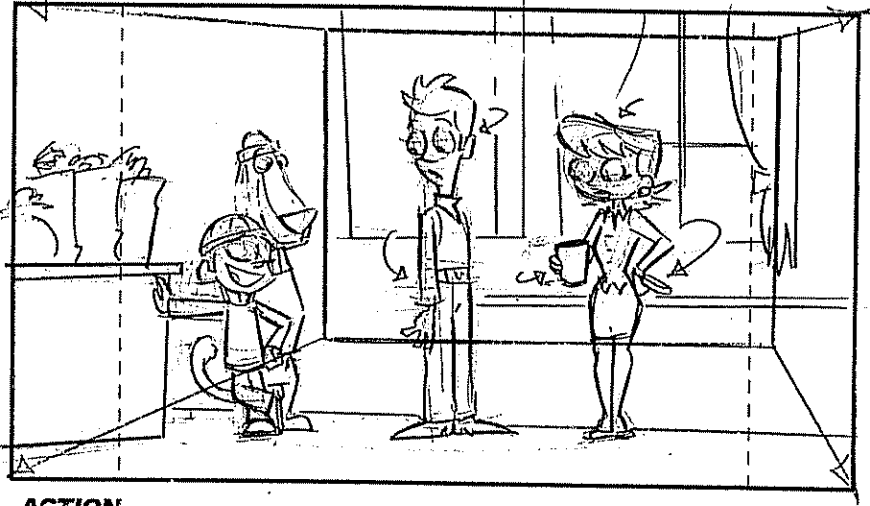

ACTION

TEK-CUT WIDE TO REVEAL Johnny & Direct.

SCENE

(22)

1/4

BG

(RZ) = DIAL - Panel #15



(CUT) Close on Johnny & Direct.

DIALOGUE

5. JOHNNY
You should just go back to the Store, ComPLAIN...

(S) Johnny:
... and buy some more.

NOTES



(RZ)

202 B

⊕ PAGE # 23A NEXT!

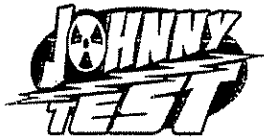

(R2) - Panel # 15

EPISODE: _____ PAGE: 023

(R2) - Panel # 15

SCENE 22 CONT'D

2/4

BG

SCENE

3/4

BG

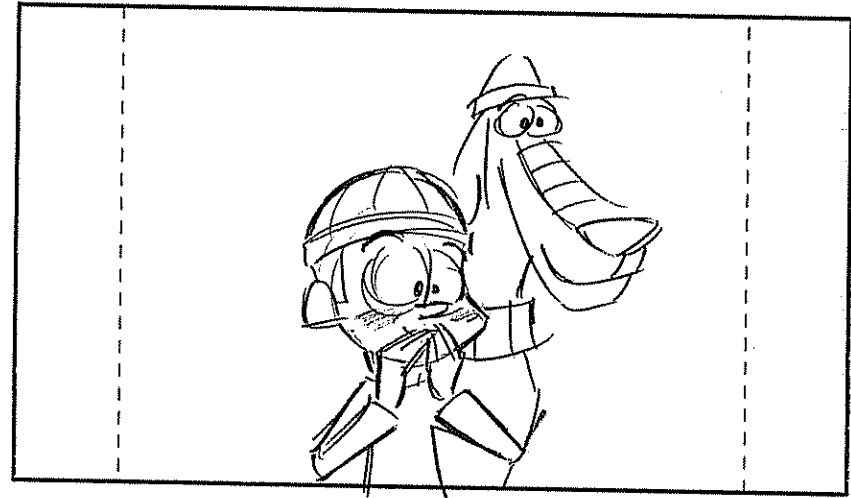
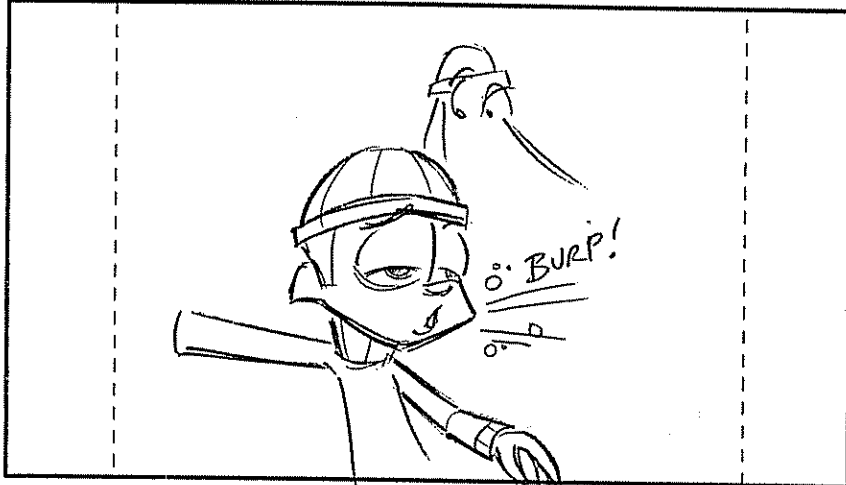

ACTION

DIALOGUE

Johnny:
(Burp!)

6. DAD (als)
That's a great idea, Johnny...

NOTES



© 2006 Johnny Test Productions Inc "Johnny Test" TM Warner Bros Entertainment Inc. All Rights Reserved

collideoscope animation studios

(R2)



2026

Re-new pg!

PAGE: 23A

Re - new panel

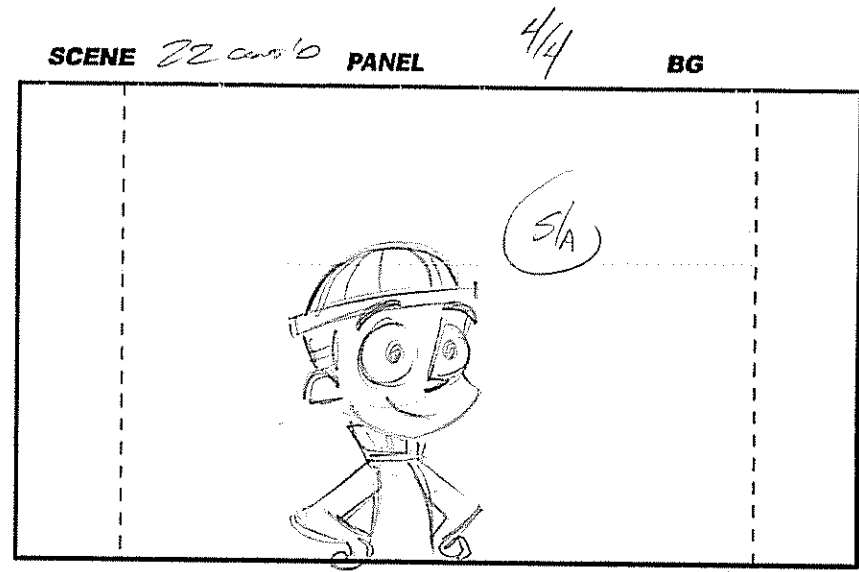
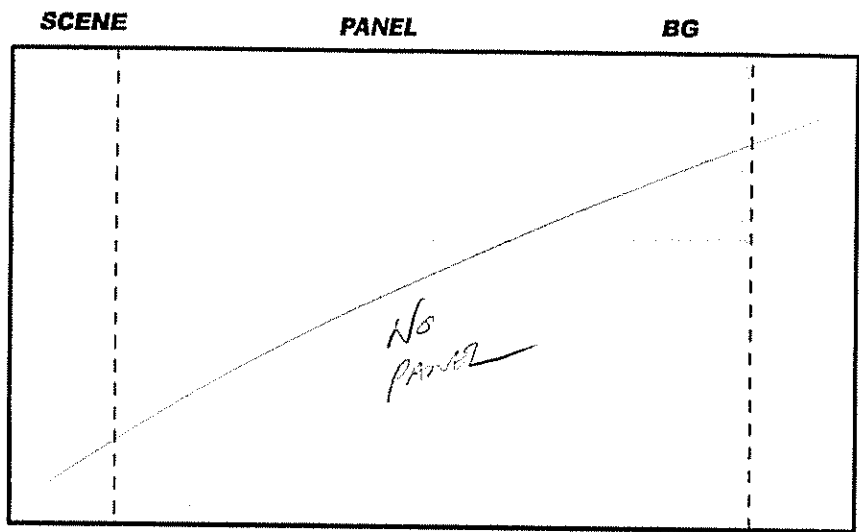

ACTION

- SCAT -

DIALOGUE

NOTES



Ⓜ - PAGE # 024A NEXT!

202B



Ⓜ - PANEL #
- DIAL

EPISODE: _____

PAGE: 024

Ⓜ - DIAL

Ⓜ - VIS
- DIAL

SCENE 023

1/4

BG

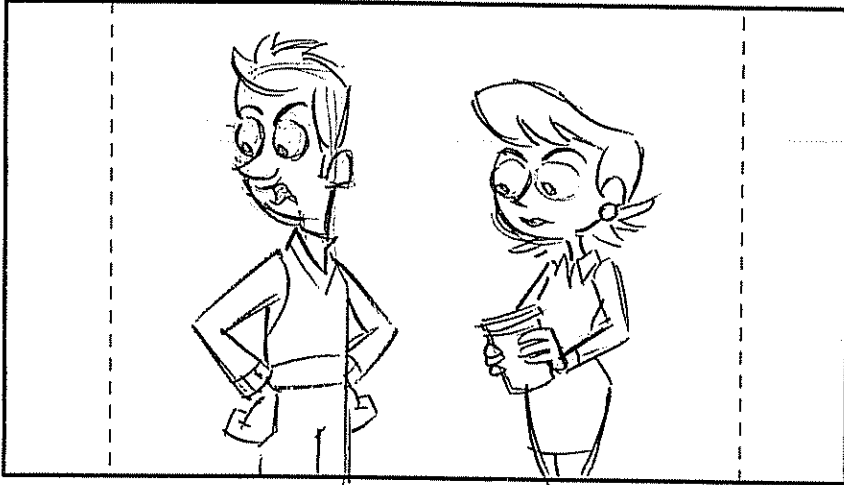

SCENE

2/4

BG



ACTION

Ⓜ TO MOM & DAD

DIALOGUE

7. DAD (CONT'D)
...IF I WAS A FOOL.

(7) DAD (CONT'D)
NO, I'M GOING TO

NOTES



© 2006 Johnny Test Productions Inc "Johnny Test" TM Warner Bros Entertainment Inc All Rights Reserved

collidescope animation studios

Ⓜ

RE-VIS
-DIAL.

RE-VIS-

RE-VIS
-ACT

SCENE 023 CONT'D PANEL

3/4

BG



SCENE

PANEL

4/4

BG



-DAD EXITS SC. R.

DIALOGUE

DAD: (CONT)
... WRITE TO THE ICE ICE CREAM COMPANY ...

DAD: (CONT)
... AND COMPLAIN!

NOTES



202B

R2 - PAGE # 025A NEXT!

EPISODE: _____ PAGE: 025

SCENE 024

BG

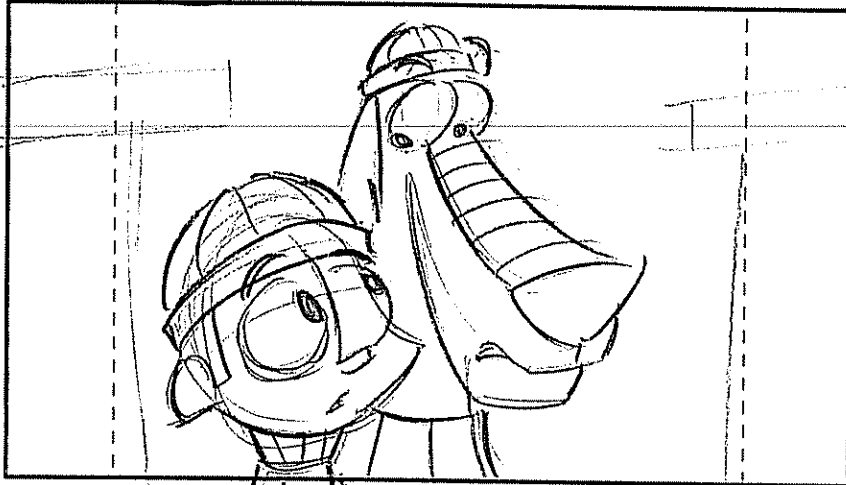

ACTION

cur

SCENE 025

BG



cur

DIALOGUE

8. MOM (cls)
And no more Mega Mint

(8) MOM : (cont'd)
...CHOP IN THIS house until we get

NOTES



© 2006 Johnny Test Productions Inc "Johnny Test" TM Warner Bros Entertainment Inc. All Rights Reserved

collideoscope animation studios

R2

702B

SCENE 025 CONT'D

PANEL 2/3

(R2) -VIS

BG

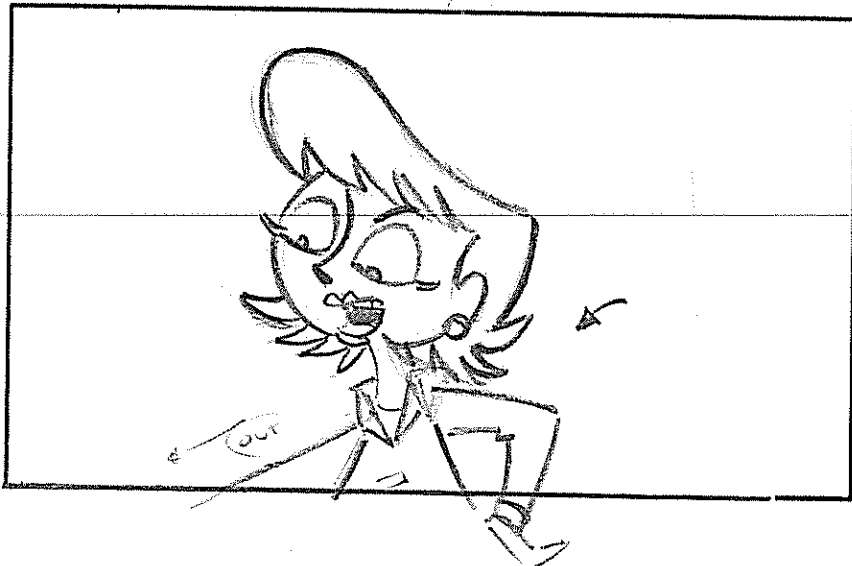

SCENE

PANEL

3/3

(R2) -VIS

BG



DIALOGUE

MOM: (cont)

... AN APOLOGY!

NOTES



202 B

(R2) - PANE #5
- VIS
- DIR

EPISODE: _____ | PAGE: 026

SCENE (026)

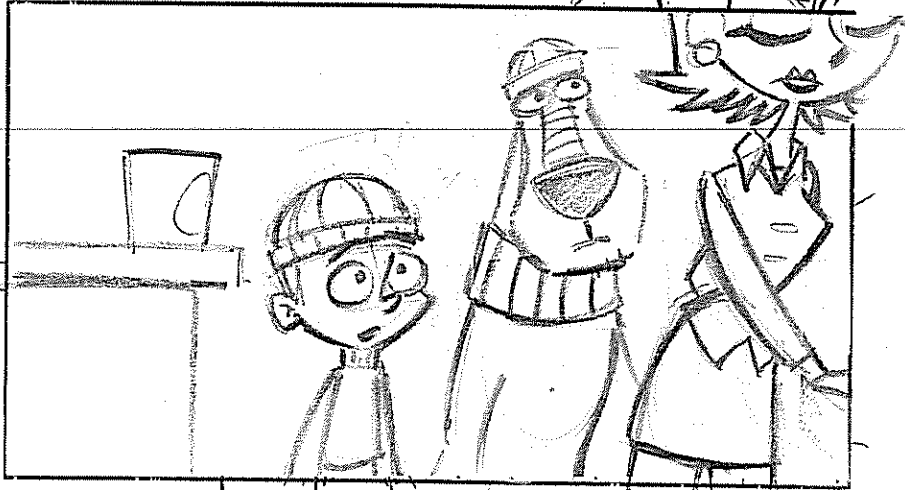

SCENE

2/3

BG



ACTION

(CUT)

(OTS) Mom and Johnny & Doreen
& EXITS RT.

- Doreen ANTICS

DIALOGUE

NOTES



© 2006 Johnny Test Productions Inc "Johnny Test" TM Warner Bros Entertainment Inc All Rights Reserved.

collideoscope animation studios

(R2)



(R2) - PANEL #3 20B B

(R2) PANEL #5

EPISODE: _____ PAGE: 027

SCENE 26 CONT'D 3/8 BG

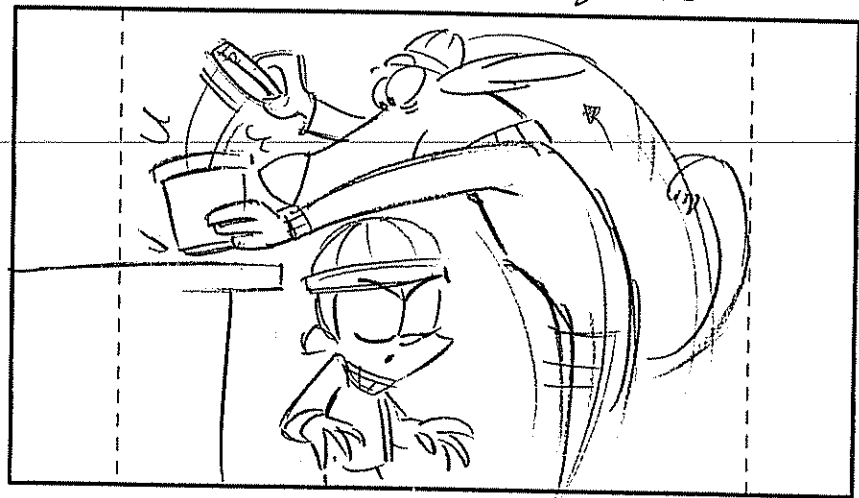

ACTION

SCENE 4/8 BG

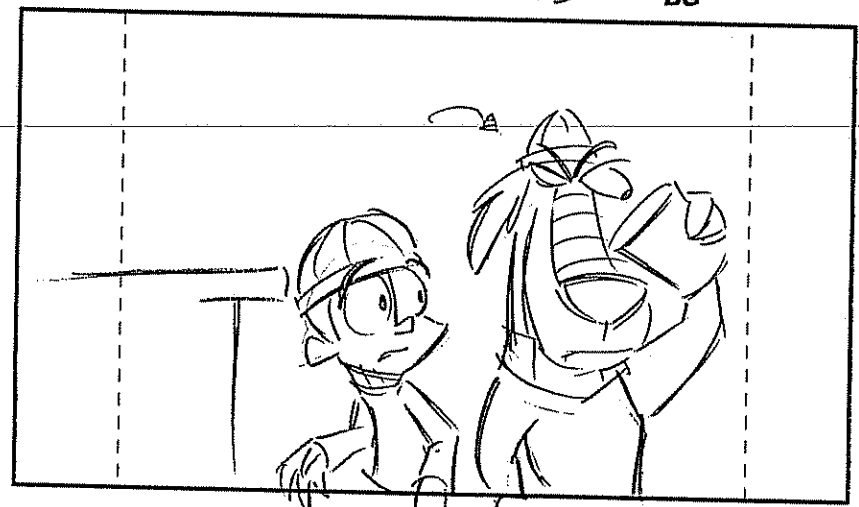

DUKEY GRABS THE EMPTY TUB -- EXAMINES IT..

DIALOGUE

NOTES



© 2006 Johnny Test Productions Inc "Johnny Test" TM Warner Bros. Entertainment Inc All Rights Reserved

collidescope animation studios

(R2)

202 B

RR - PAGE# 028A NEXT!



EPISODE: _____ PAGE: 028

RR - PANEC

RR - PANEC

SCENE 26 cont'd

5/8

LOSE HAT

BG

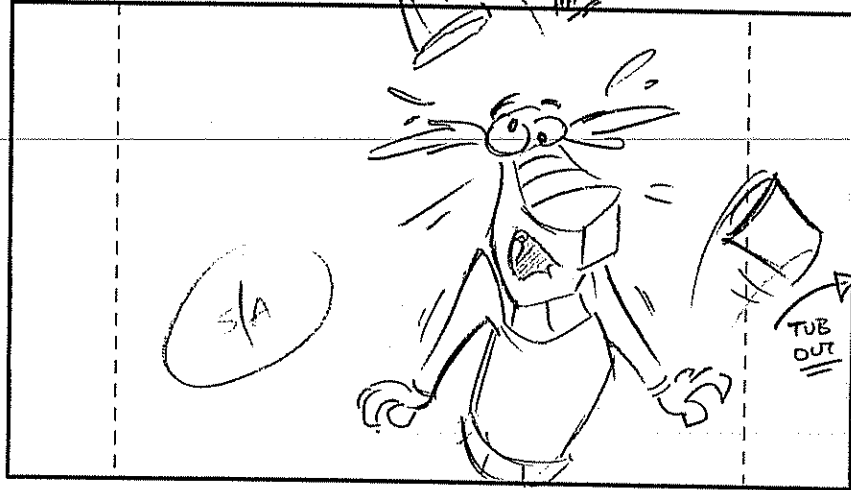

ACTION

Dukey "THINGS" LOSING HIS HAT & TUB.

SCENE

4/8

BG

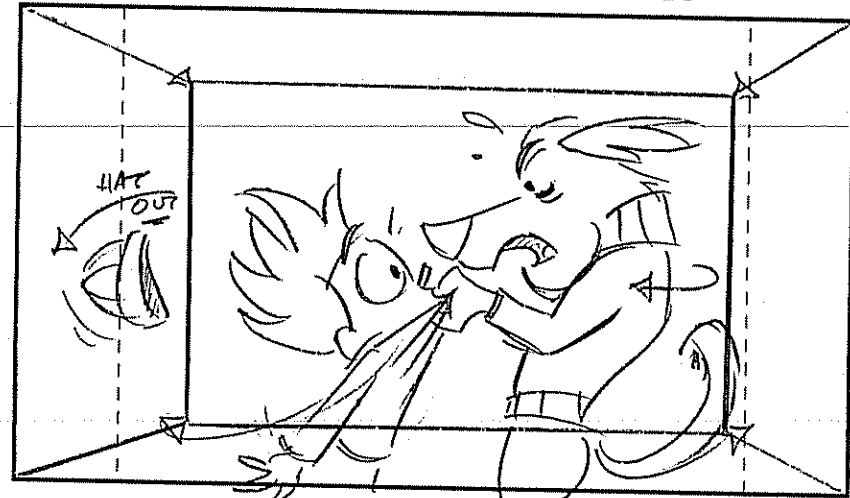

TAK-UP ON DUKEY GRABBING JOHNNY!

DIALOGUE

9. DUKEY
What are we supposed to do?

I NEED mint chip ice cream. It's what
makes my coat so shiny!

NOTES



© 2006 Johnny Test Productions Inc. "Johnny Test" TM Warner Bros Entertainment Inc. All Rights Reserved

collide@scope animation studios

RR



R3 - VIS. 202B
R2 - VIS

R2 - NEW PAGE.

PAGE: 028A

SCENE 26 CONT'D PANEL 2/8

BG

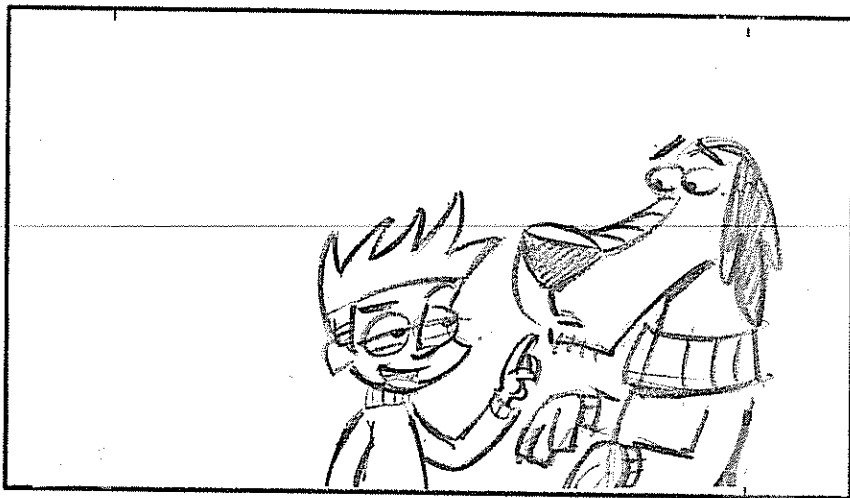

SCENE

PANEL

BG

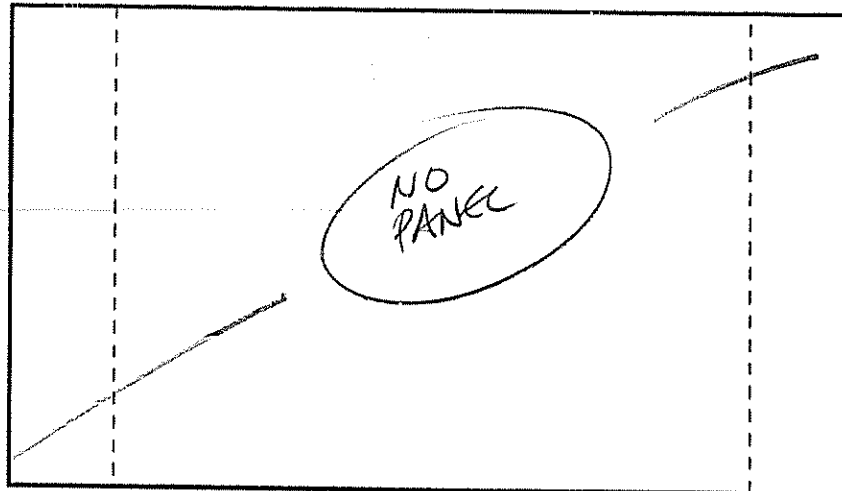

ACTION

DIALOGUE

(10) Johnny:
Don't worry, we got
a plan!

NOTES





202 B

EPISODE: _____ PAGE: 029

(R2) - VIS

(R2) - Panel #15

SCENE 26 cont'd

7/8

BG

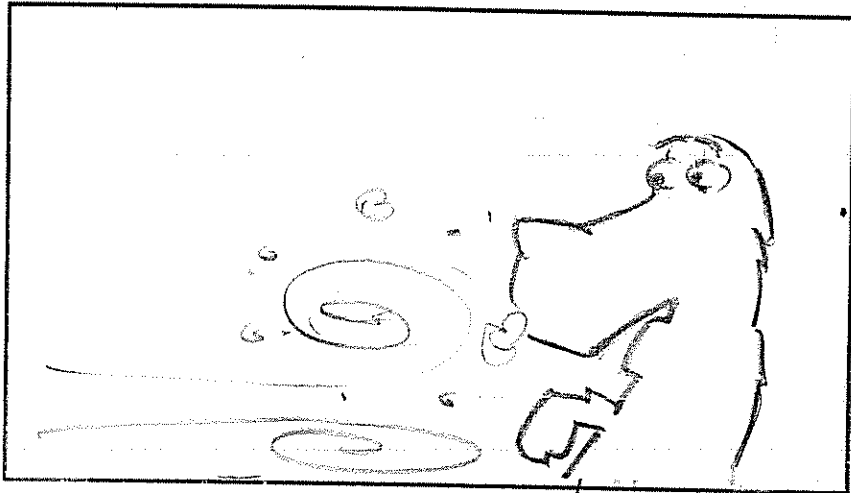

ACTION

JOHNNY 2175 O/S L.T
←

SCENE (027)

1/3

BG

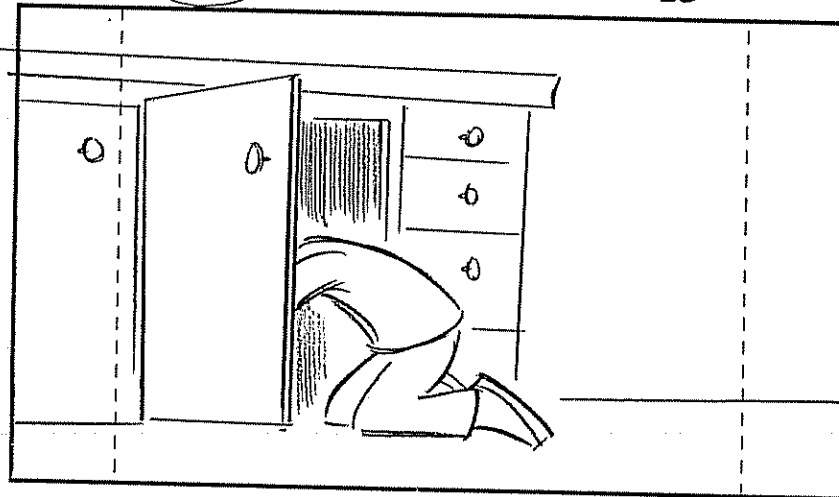

(CUT)

JOHNNY SHUFFLES BENEATH THE COUNTER..

DIALOGUE

NOTES



© 2006 Johnny Test Productions Inc "Johnny Test" TM Warner Bros Entertainment Inc. All Rights Reserved

collidescope animation studios

(R2)



(R2) - Panel #15

2023

(R2) - PAGE # 030A NEXT!

EPISODE: _____ PAGE: 030

(R2) - NEW PANELS

SCENE 27 cont'd 2/3 BG

SCENE _____ PANEL 2/3 BG

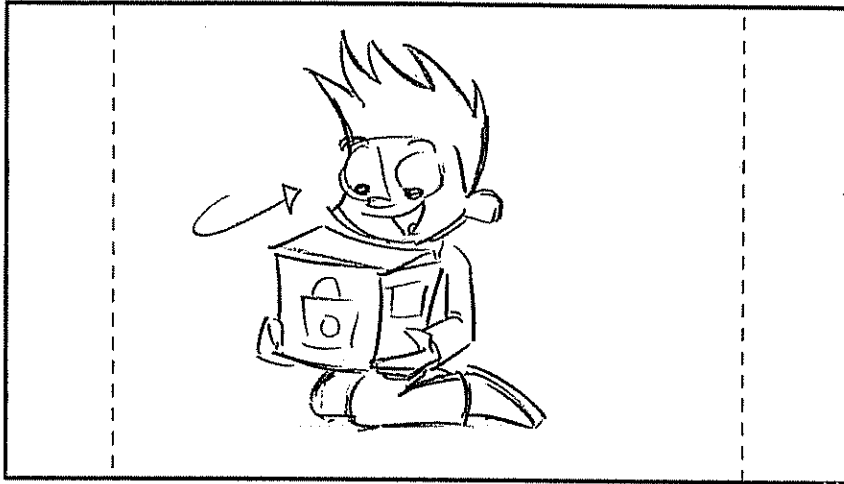

ACTION

- AND PULLS OUT AN ICE CREAM MAKER...

Johnny BLEW DUST OFF BOX.

DIALOGUE

11. DUKEY: (o/s)
← An Ice Cream Maker?

* Johnny: (ADR)
(Blow!)

NOTES



© 2006 Johnny Test Productions Inc "Johnny Test" TM Warner Bros Entertainment Inc All Rights Reserved.

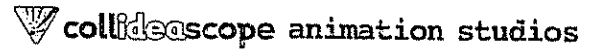

(R2)

2025

R2 - VIS.
- PANELS.

R2 - VIS.
- SCRIPT.

SCENE 028

PANEL

1/4

BG



ACTION

CUT ON DUKEY AS JOHNNY ENTERS.

SCENE

PANEL

2/4

BG

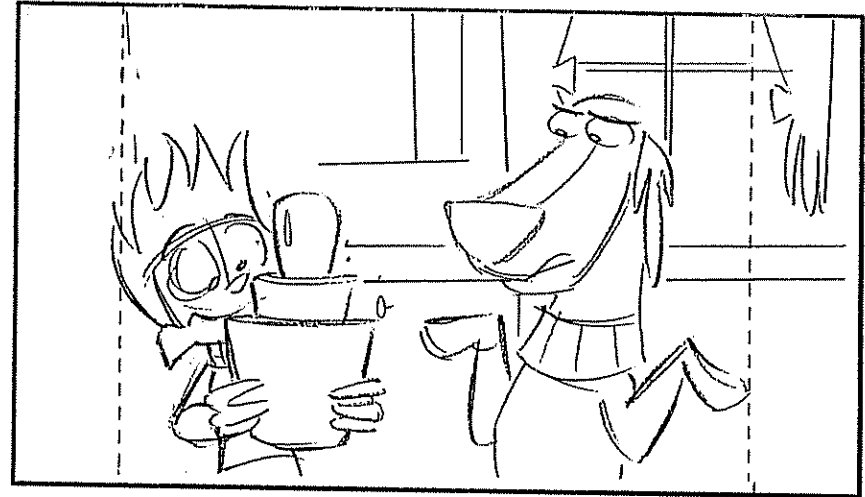

DIALOGUE

(1) DUKEY: (CONT)

JOHNNY, NOBODY ACTUALLY USES
THOSE THINGS,

DUKEY: (CONT)

THEY JUST RE-GIFT THEM.

NOTES

202B

⊕ PAGE # B1A NEXT!



EPISODE: _____ | PAGE: 631

SCENE 28 CONT'D

3/4

BG

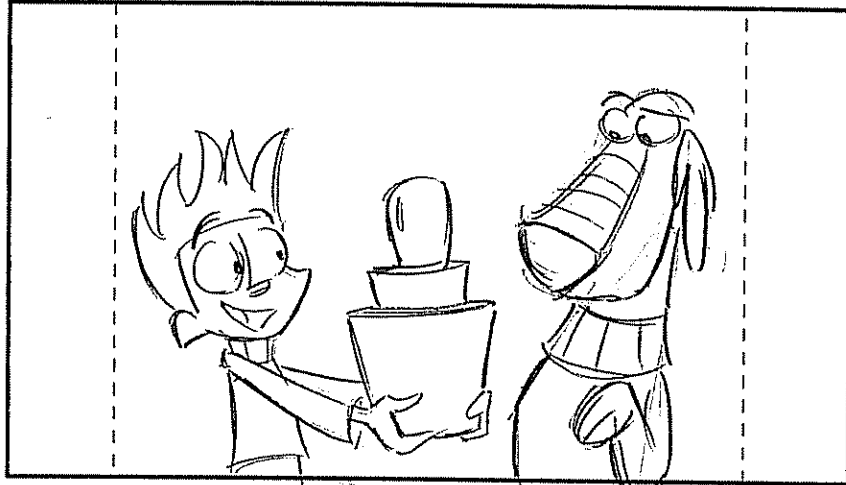

ACTION

SCENE

4/4

BG



WIPE OUT →

DIALOGUE

12. JOHNNY
Well, we are gonna make endless
GALLONS OF MINT-CHIP!

NOTES



© 2006 Johnny Test Productions Inc. "Johnny Test" TM Warner Bros Entertainment Inc. All Rights Reserved

collidescope animation studios

(R2)



2020

EPISODE: _____

PAGE: _____

31A

(P) - DIAL

SCENE 029

1/1

BG

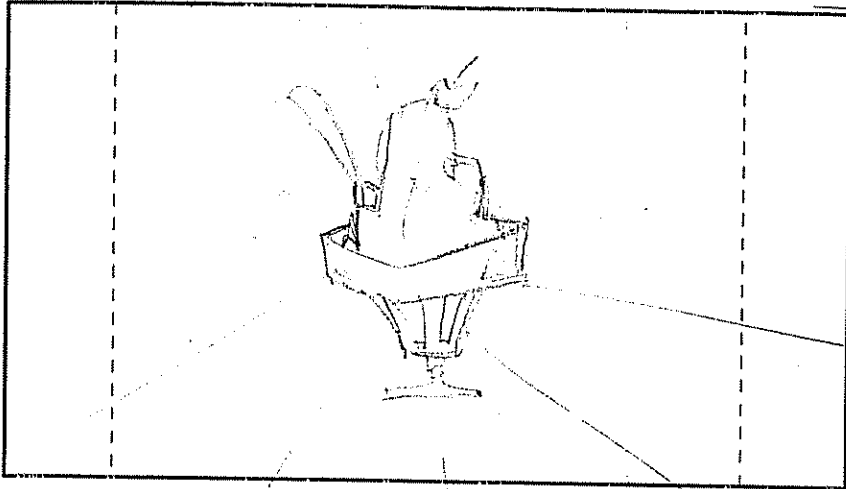

ACTION

ICE CREAM WIFE

SCENE 030

1/3

BG

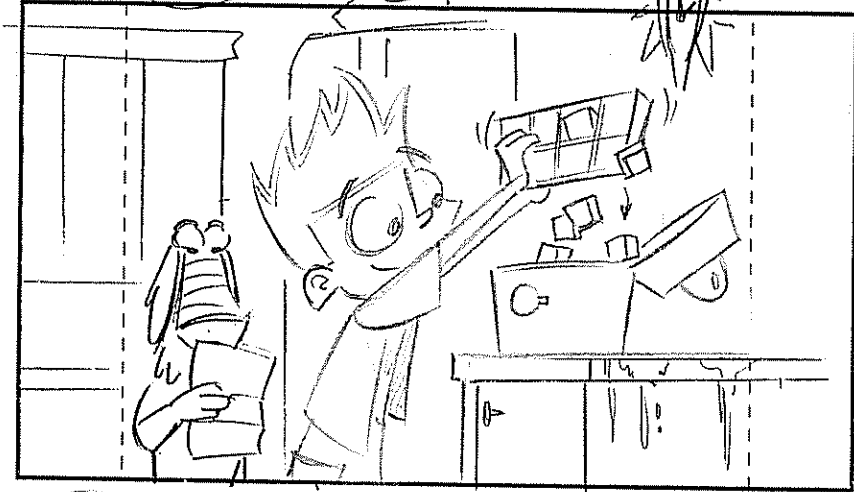

WIFE
IN

- JOHNNY POURS CREAM INTO THE MAKER.

DIALOGUE

DIAL: (GT) / (13) Johnny
ICE... ICE...

NOTES



(R3 - VIS)

(R - DIAL)

2023

⊕ PAGE # 32A NEXT!

PAGE: 32

(R - DIAL)

SCENE 30 CONT'D PANEL 2/3 BG

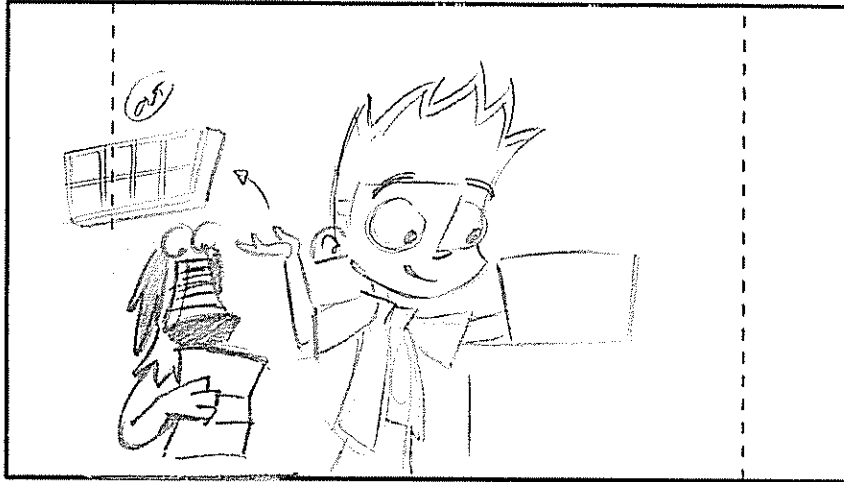

ACTION

Johnny THROWS AWAY ICE CUBE TRAP

SCENE PANEL 3/3 BG



Johnny POURS CREAM.

DIALOGUE

Durof: (GT)
PINT OF CREAM...

Johnny:
PINT OF CREAM..

NOTES

(R) - Dial

(R) - Dial

SCENE (31)

PANEL

BG

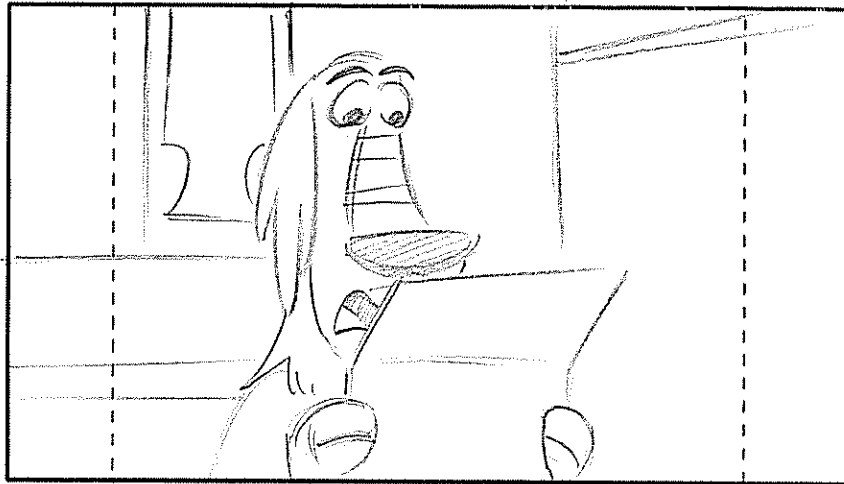

ACTION

(CUT) To Doree/READING

SCENE (32)

PANEL

BG

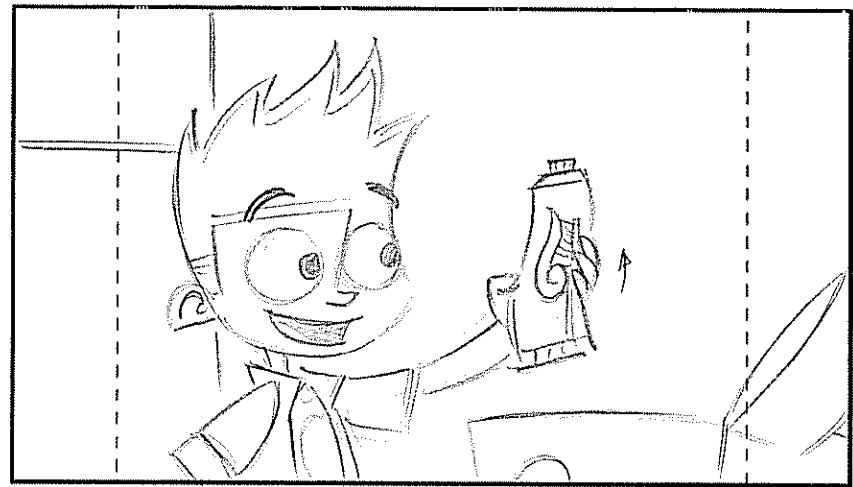

(CUT) To Johnny HOLDING TOOTH PASTE.

IALOGUE

Doree: (GT)
MINT...

Johnny: (GT)
FRESH MINTY...

NOTES

(12) - DICK

SCENE 32 cont'd PANEL 2/2 BG



ACTION

Johnny SQUEEZES PASTE

SCENE (32A) PANEL 1/1 BG

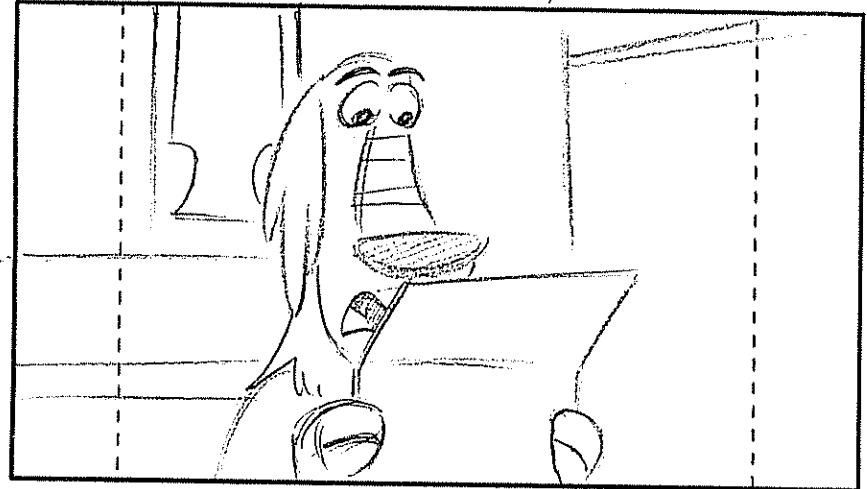

(CAT)

BACK TO DICK

DIALOGUE

JOHNNY: (CONT) (GT)

... Flavour

DICK: (GT)

CHIPS...

NOTES

(R) - DIAL

SCENE (33) PANEL 1/2 BG

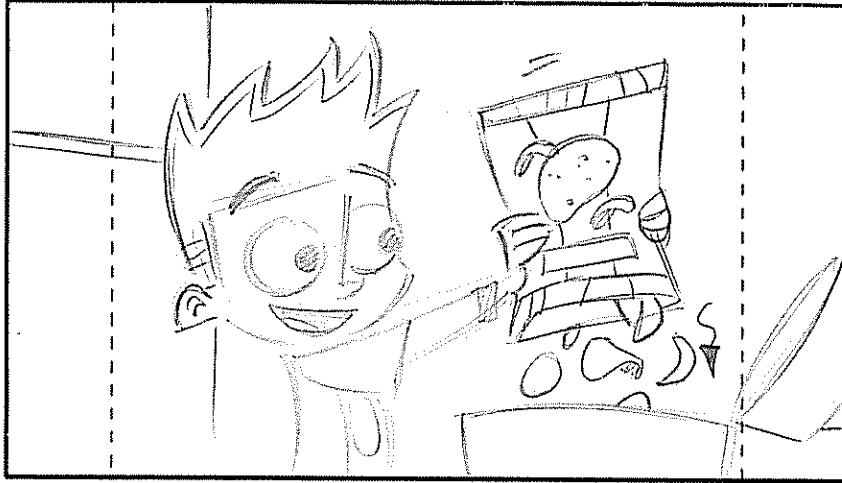

ACTION

(cut) To Johnny Presents CHIPS

SCENE (33A) PANEL 1/2 BG

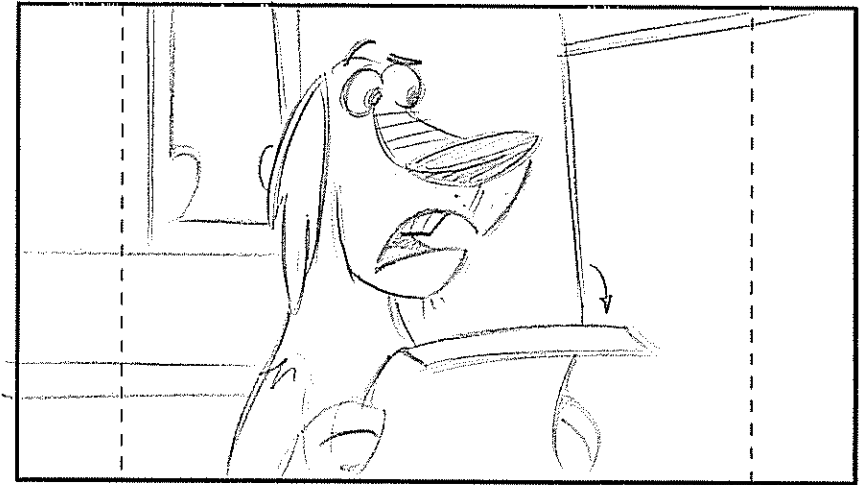

(cut) BACK TO DIAL.

DIALOGUE

Johnny:
BAG O' POTATO CHIPS ...

(14) Dial:
IT ALSO SAFE TO USE ...

NOTES

SCENE 34 PANEL 1/4 BG

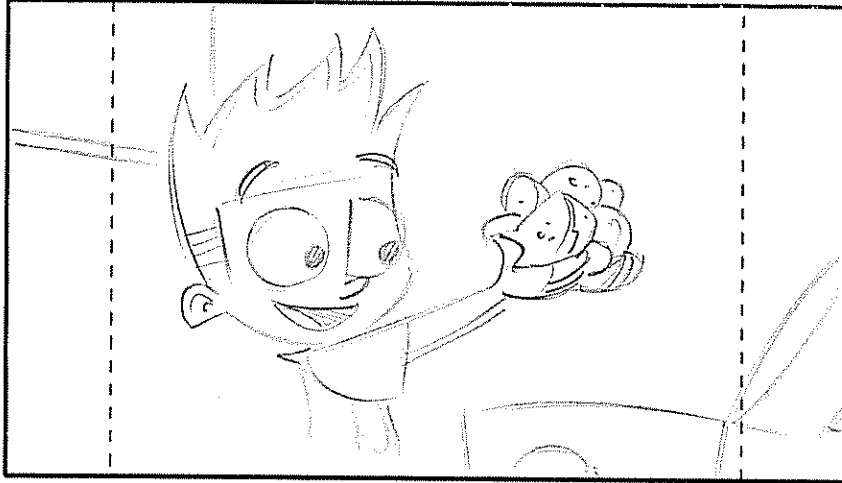

ACTION

OK To Johnny Holding
cookies.

SCENE PANEL 2/4 BG

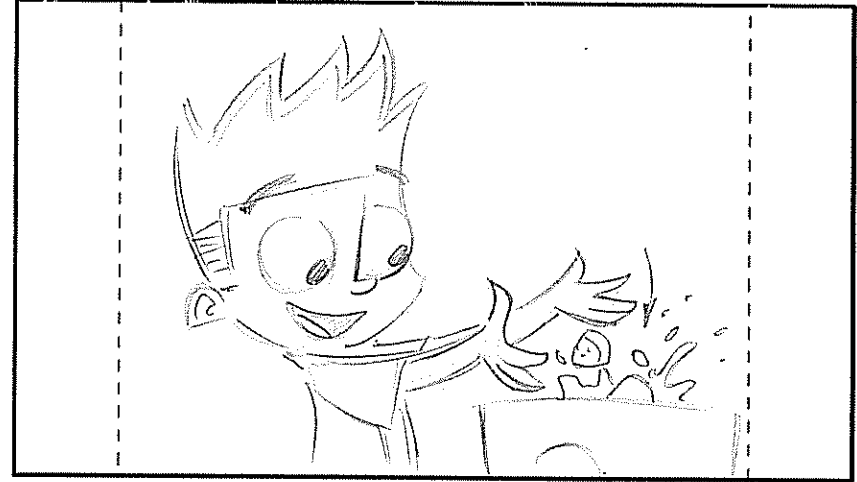

DIALOGUE

(14) Duke: (cont'd of 13)
... ROCK SALT.

(15) Johnny:
cookies (SFX: (SPROUT!))

NOTES

SCENE 34 *Cont'd* PANEL 3/4 BG



ACTION

Johnny REACTS Dead

SCENE PANEL 4/4 BG

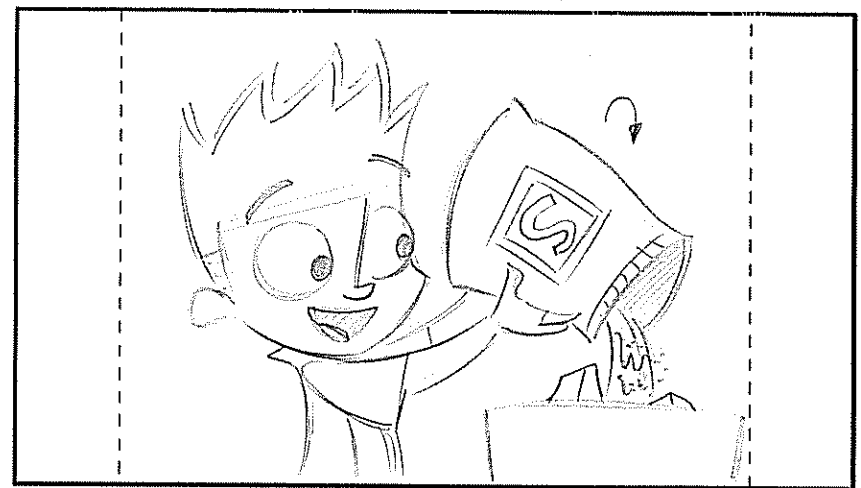

AND LIFTS & POURS A BAG OF SALT!

DIALOGUE

(15) Johnny: (cont'd)

... AND ...

... SALT!

NOTES



202 B

(R2) - PAGE #034A NEXT

EPISODE: _____ | PAGE: 034

SCENE 035

1/2 BG



ACTION

MEDIUM AS JOHNNY POURS SHOT

(W)

SCENE

2/2 BG

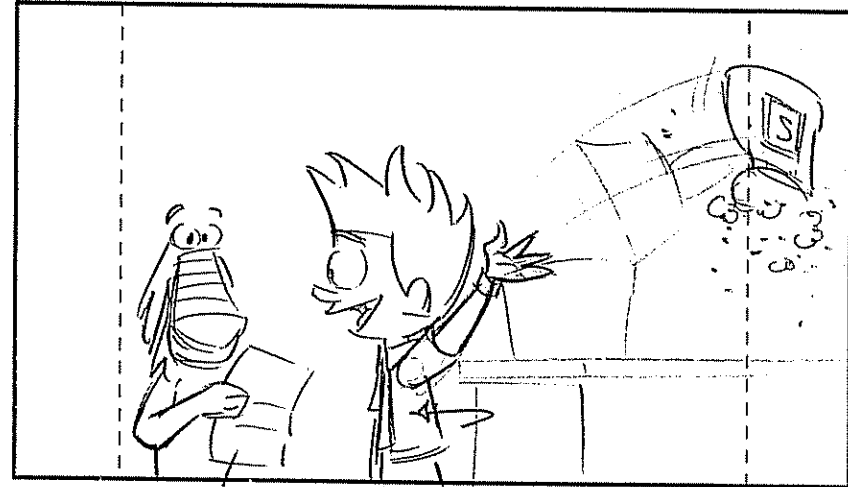

JOHNNY THROWS BAG AWAY & TURNS TO DUKEY.

DIALOGUE

(15) JOHNNY - (CONT'D)

Done! Now what?

NOTES



© 2006 Johnny Test Productions Inc "Johnny Test" TM Warner Bros Entertainment Inc. All Rights Reserved

collidescope animation studios

(R2)

Ⓜ - VIS

Ⓜ - VIS
- DIAL.

SCENE 036 PANEL 1/2 BG

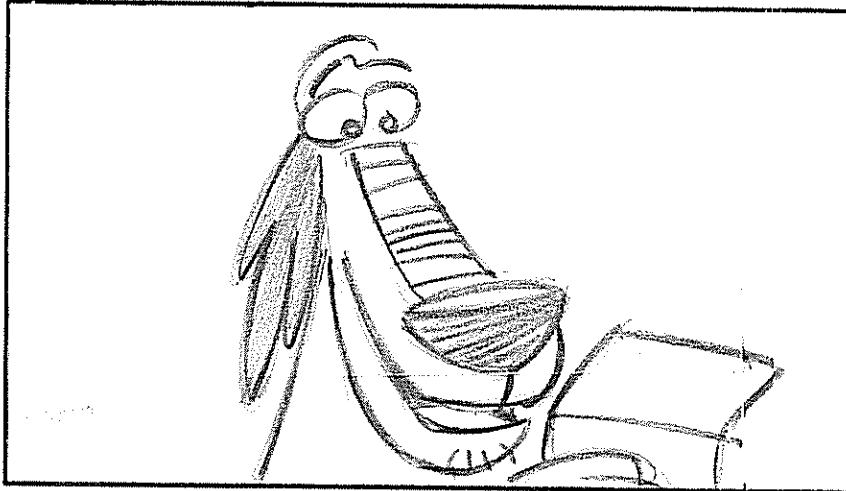

ACTION

CUT

CLOSE ON DUKEY...

SCENE PANEL 3/2 BG

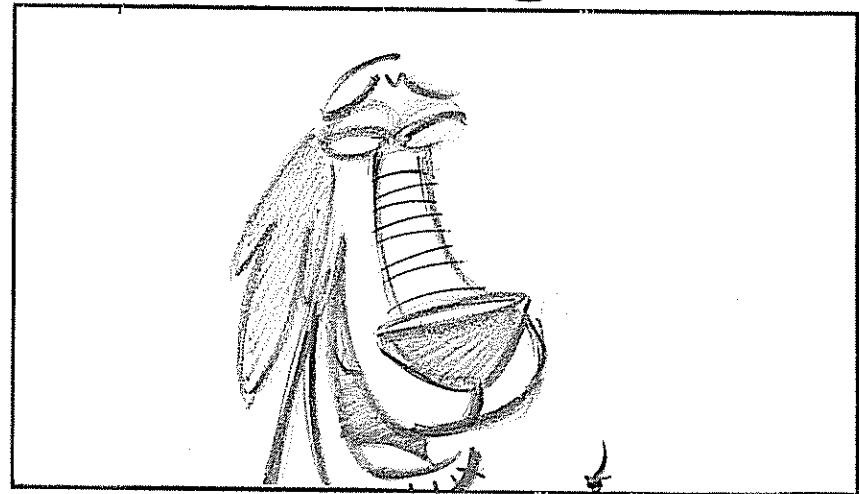

DIALOGUE

Ⓜ DUKEY:
NOW WE TURN IT ON AND IN JUST



DUKEY: (CONT)
... THREE HOURS WE'LL HAVE DELICIOUS
MINT CHIPPY ICE CREAM!

NOTES



202B

EPISODE: _____ | PAGE: 035

(R2) - PANEL SCRIPT.

(R2) - VIS
- DIRC.

SCENE

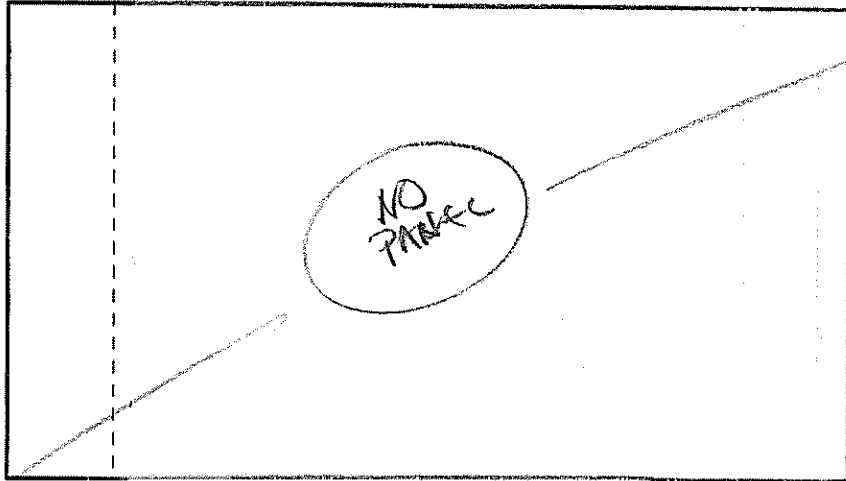

SCENE (037)

1/4

BG

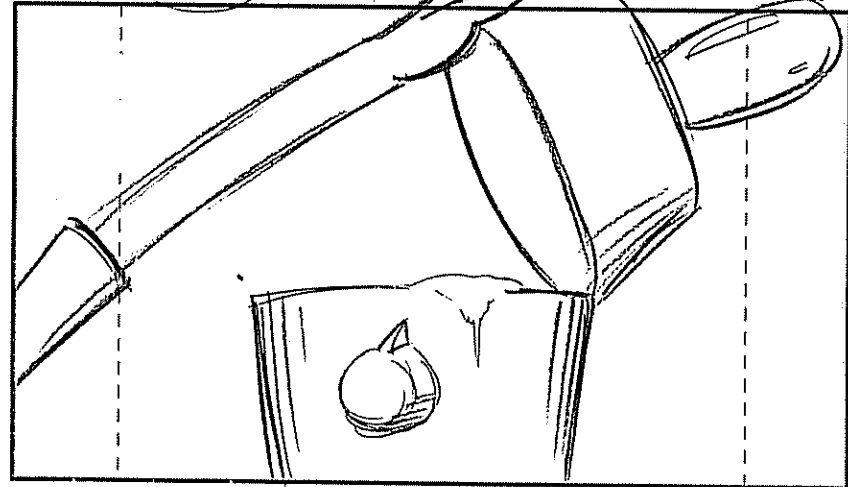

ACTION

(CUT)

CLOSE ON ICE CREAM MAKER
JOHNNY'S ARM ON LID.

DIALOGUE

NOTES



© 2006 Johnny Test Productions Inc "Johnny Test" TM Warner Bros Entertainment Inc All Rights Reserved

collidescope animation studios

(R2)

202B



EPISODE: _____

PAGE: 036

SCENE 37 cont'd

3/4

BG

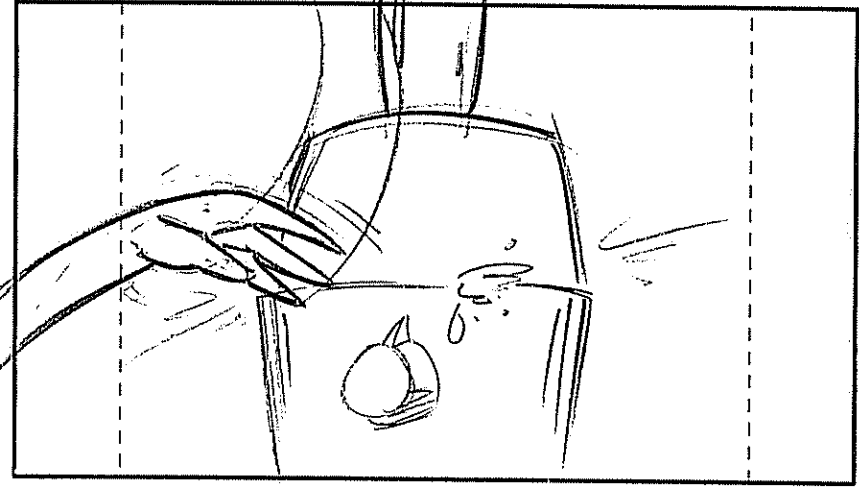

ACTION

SCENE

3/4

BG

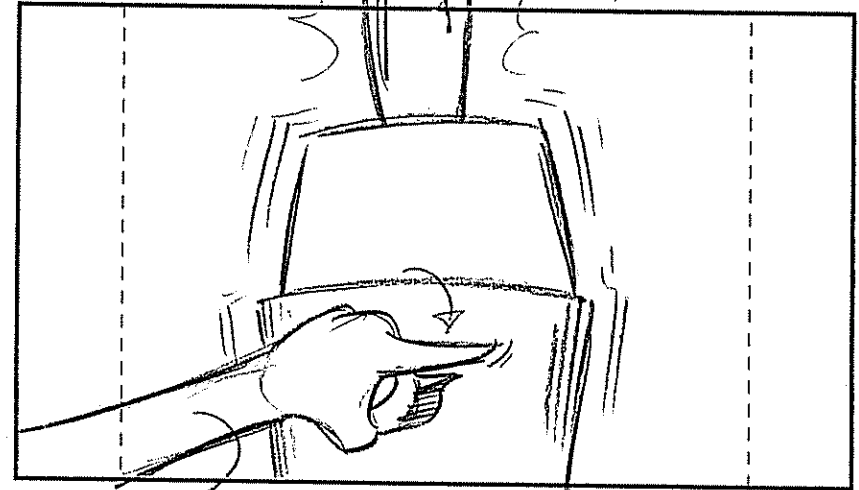

△ HAND/ARM OUT

- MAKE LIGHTS UP & SHAKE

DIALOGUE

NOTES



202B

EPISODE: _____

PAGE: 037

1/4
SCENE # 037
CONT.

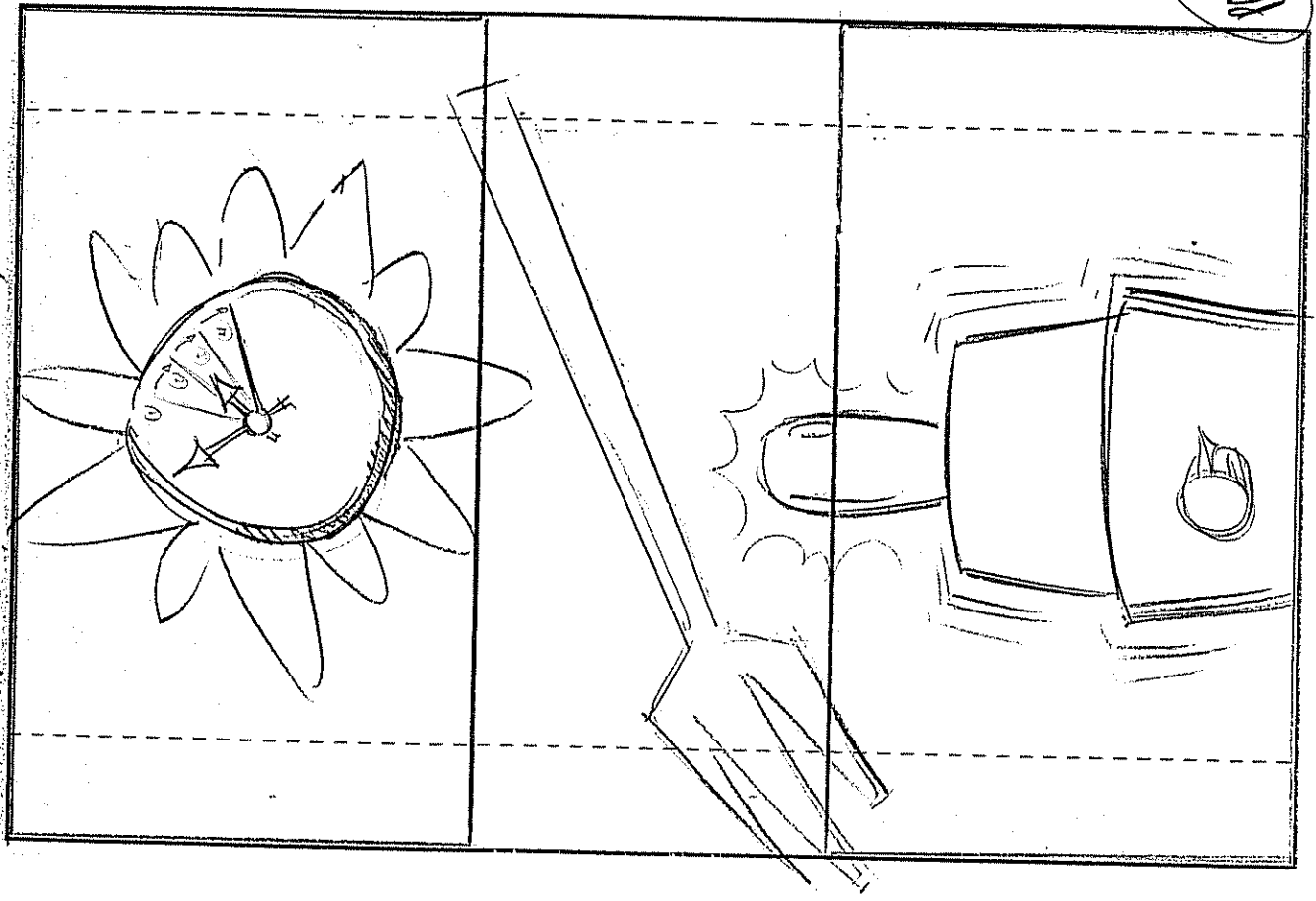

Hand
A

- LIGHT FLASHES RED
 - PAN UP TO CLOCK ON WALL
 (SECOND HAND MOVES X3)

DIALO

SFX
 (CLOCK TICKS X3)

202 B

(R2) -VIS

SCENE (038)

BG

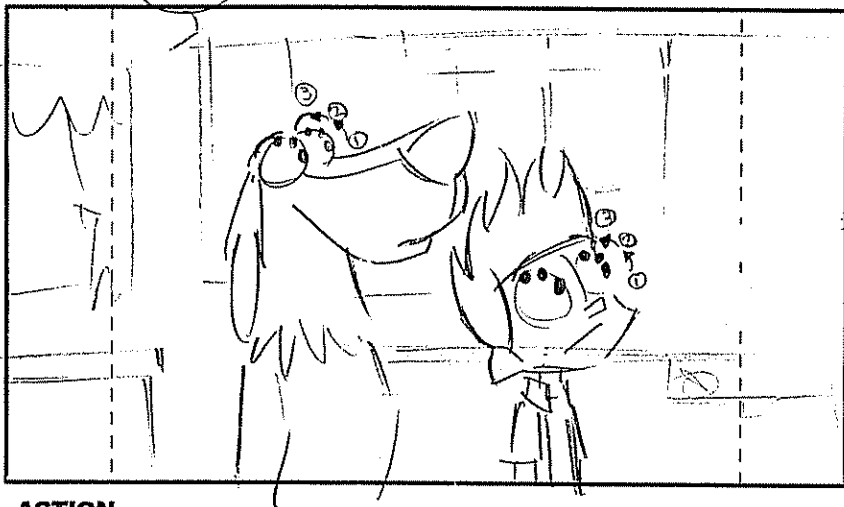

ACTION

(WR) To DIAL OF 5 JOHNNY AS THEIR PUPILS FALL ON O/S CLOCK

SCENE (039)

BG

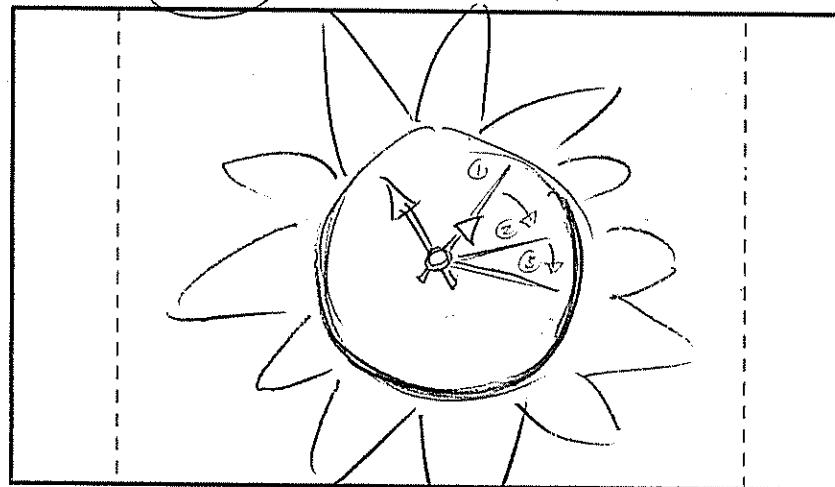

(WR) TO CLOCK AS SECOND HAND CONTINUES.

DIALOGUE

SFX: (O/S)
(CLOCK TICKS X 2)

SFX: X2
(CLOCK TICKS X 5)

NOTES

(R2)

2023



EPISODE: _____

PAGE: 039

SCENE (040)

BG

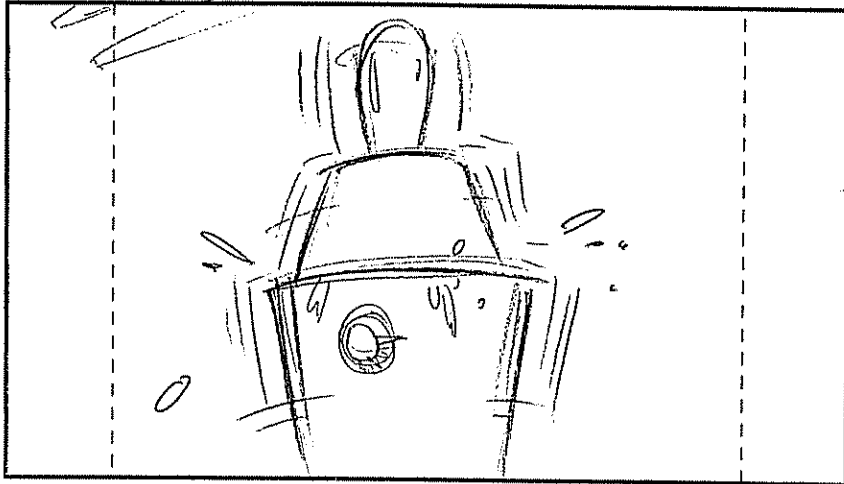

ACTION

KE CREAM MAKER CONTAINERS
TO SHAKE!

SCENE (041)

BG



(Cov)

TO DANCE & JOYFUL.

DIALOGUE

17. JOHNNY
Maybe we should do something to
make the time go by faster.

NOTES



© 2006 Johnny Test Productions Inc. "Johnny Test" TM Warner Bros Entertainment Inc All Rights Reserved

collidescope animation studios

202B



EPISODE: _____

PAGE: 040

SCENE

042

1/2

BG

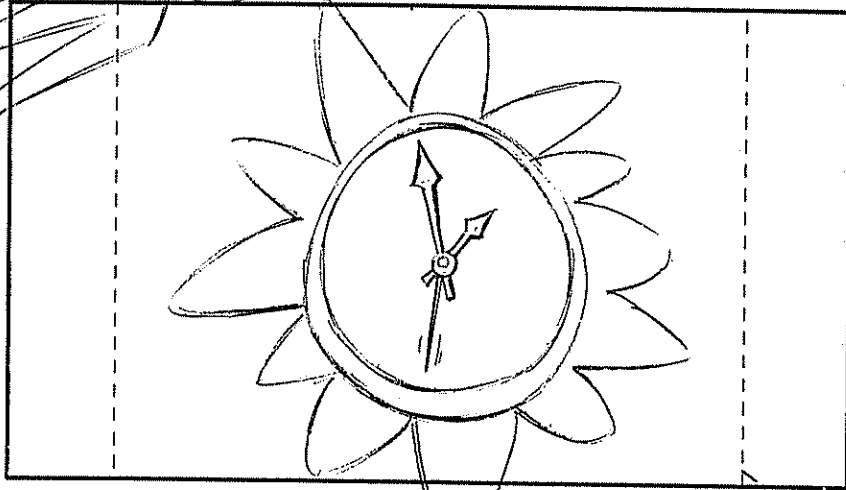

SCENE

2/2

BG

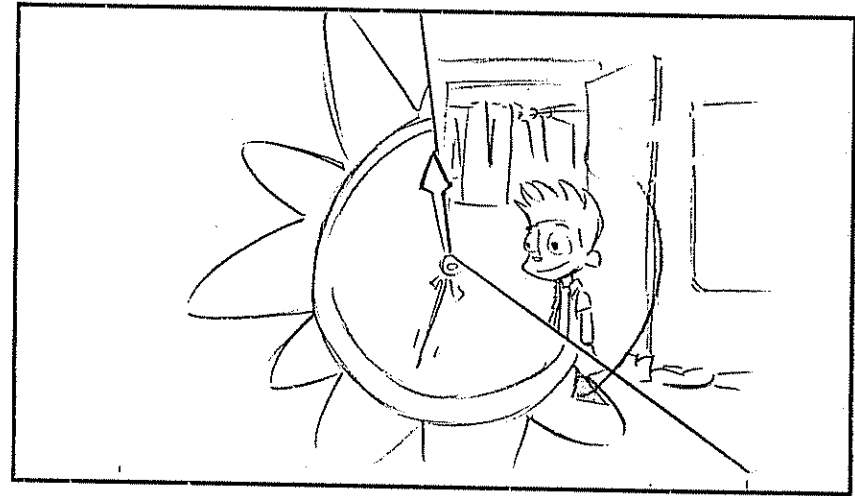

ACTION

CR

TO CLOCK

WIPE
CLOCK-
WISE

TO JOHNNY & DICK AT CLOSET

DIALOGUE

NOTES



© 2006 Johnny Test Productions Inc "Johnny Test" TM Warner Bros. Entertainment Inc. All Rights Reserved

collidescope animation studios

202 B



* NO SC 4E!

EPISODE: _____

PAGE: 041

SCENE (044)

BG

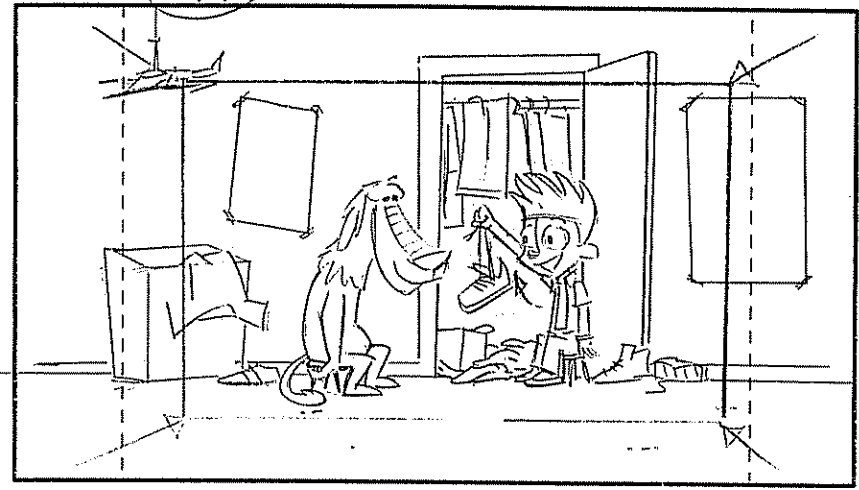

ACTION

(WIPE IN) - QUICK TRAIL-IN AS JOHNNY LIFTS SHOE.

SCENE (045)

BG

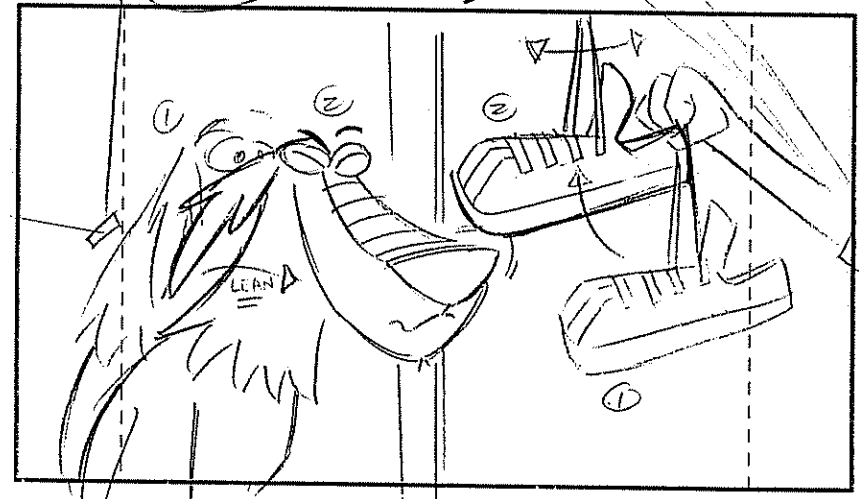

(CUT) CONT. LIFT SHOE AS DUKO LEANS TO SNIFF IT.

DIALOGUE

18. JOHNNY
Here, try this one.

SFX:

SNIFF! SNIFF! SNIFF!!!

NOTES





202 B

⌘ PAGE # 42A NEXT!

EPISODE: _____ | PAGE: 042

SCENE 15 cont'D 2/5 BG

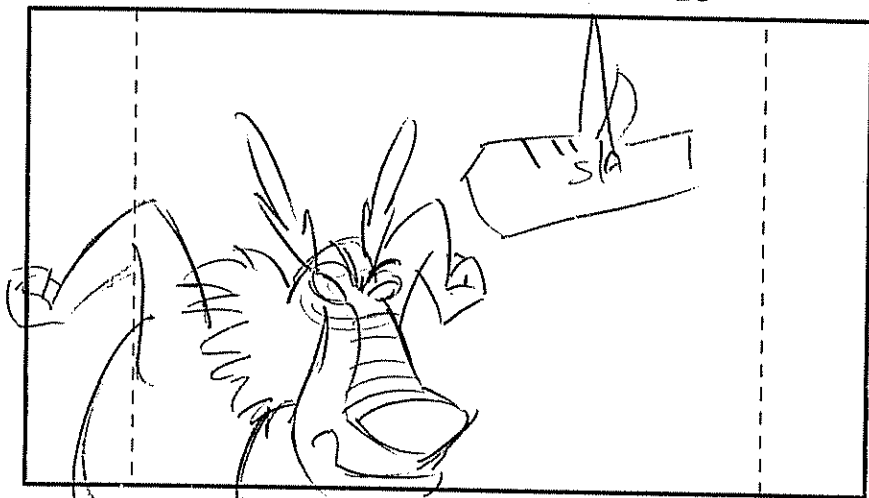

ACTION

Duke/ARTIC

SCENE 3/5 BG



Duke/ REACTS AS SNEAKER LETS.

DIALOGUE

19. DUKEY
EWWW!!!

NOTES



© 2006 Johnny Test Productions Inc "Johnny Test" TM Warner Bros. Entertainment Inc. All Rights Reserved

collideoscope animation studios

SCENE 45 cont'd PANEL 4/5 BG

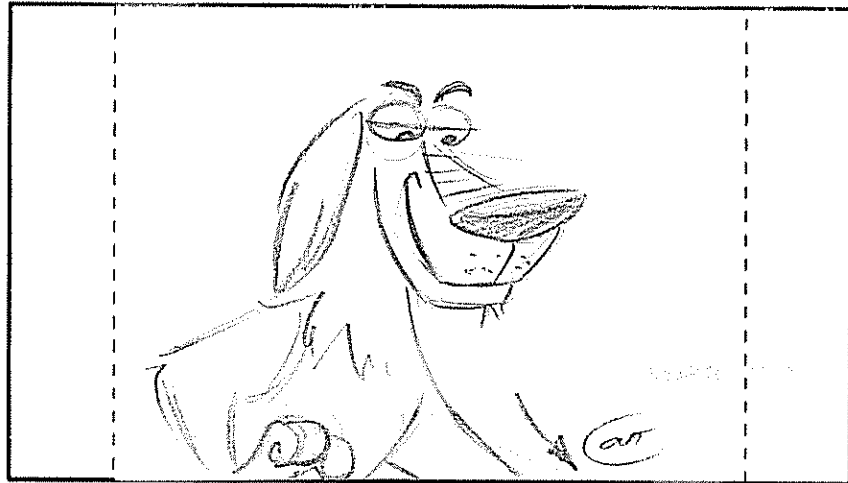

ACTION

Direct Reaches Panel d/s.

SCENE PANEL BG

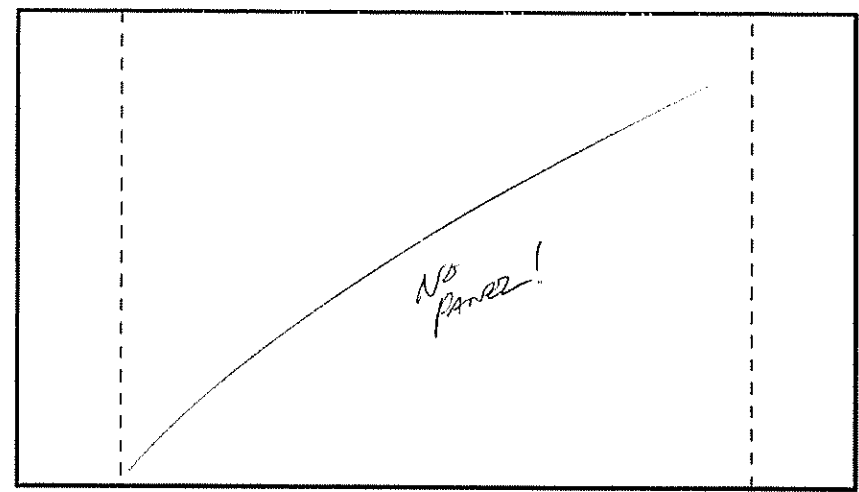

DIALOGUE

NOTES

202B



SCENE

45 cont'd 3/5

BG

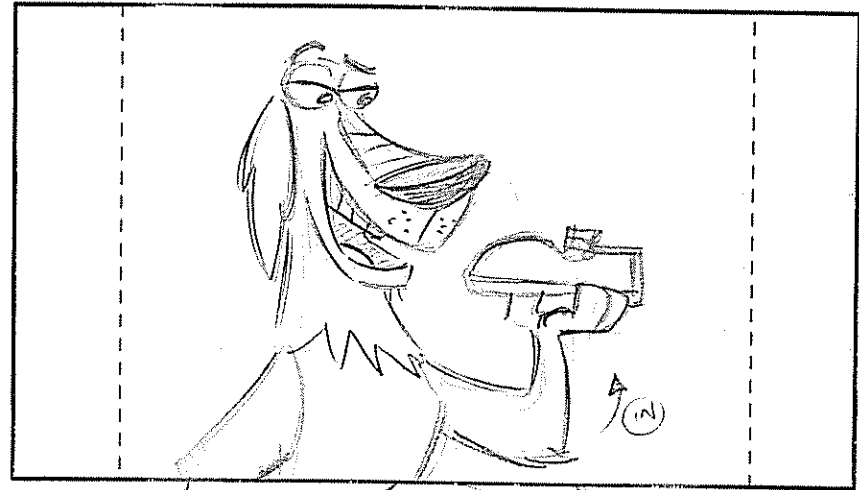

ACTION

Duke/ RAISES SLICE IN.

DIALOGUE

Duke/ = (Cont'd ADR)
You TRY THIS ONE!

NOTES

SCENE (046)

1/4

BG



(WR)

CLOSE on Johnny/
- Duke's ARM & SLICE IN
- JOHNNY SNIFFS

(LIG) Johnny/
(SNIFF - SNIFF)





202 B

EPISODE: _____

PAGE: 044

SCENE

46 Cont'd

2/4

BG



ACTION

SCENE

3/4

BG

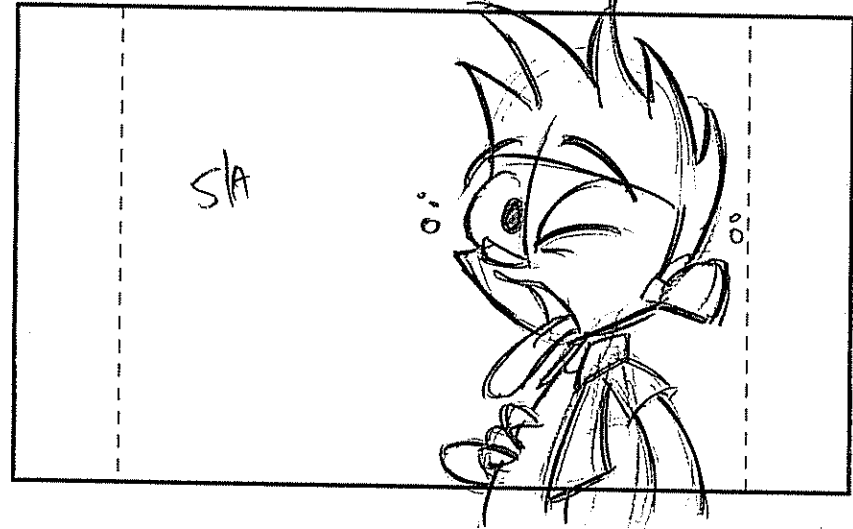

DIALOGUE

Johnny =
UNGH!!!

NOTES



© 2006 Johnny Test Productions Inc "Johnny Test" TM Warner Bros Entertainment Inc. All Rights Reserved

collideoscope animation studios



2023

~~4~~ PAGE # 45A NEXT!

EPISODE: _____ | PAGE: 045

SCENE

H6 Cont'd

4/4

BG

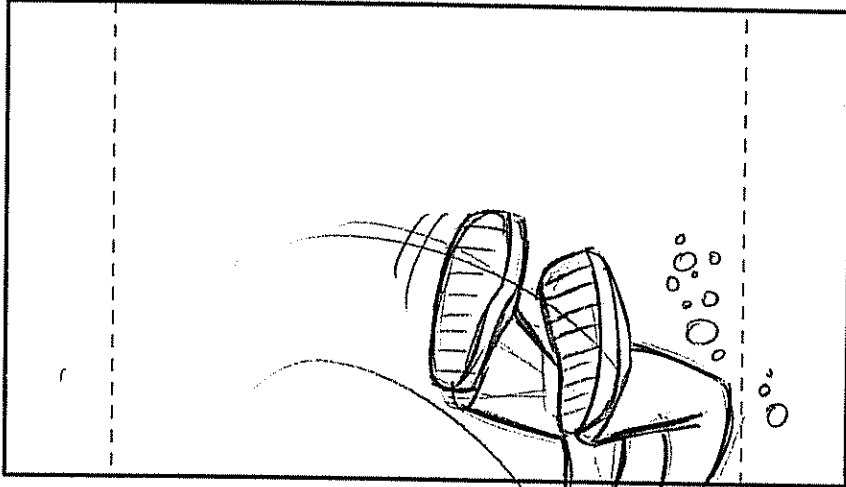

SCENE

PANEL

BG

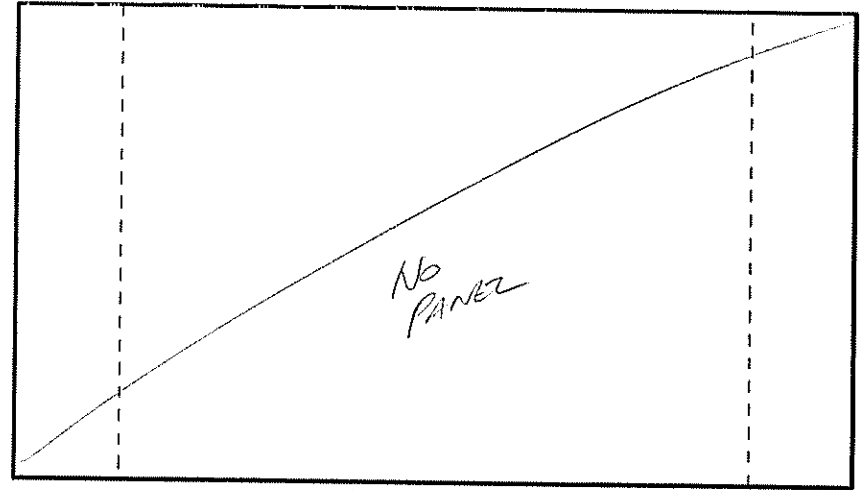

ACTION

DIALOGUE

NOTES



© 2006 Johnny Test Productions Inc. "Johnny Test" TM Warner Bros Entertainment Inc All Rights Reserved

collidoscope animation studios

SCENE 47

PANEL 1/2

BG

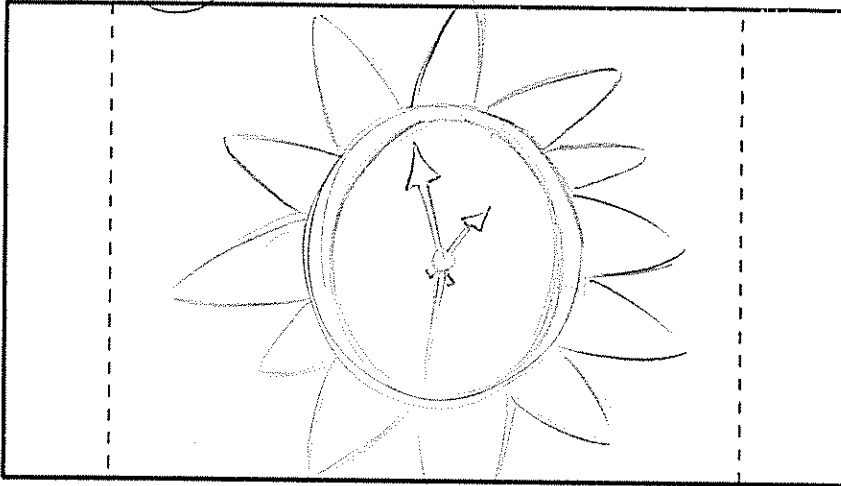

ACTION

Cut To Clock

WIPE
Clock - WIPE → To ICE CREAM MAKER

DIALOGUE

NOTES

(R2 - ACTION)

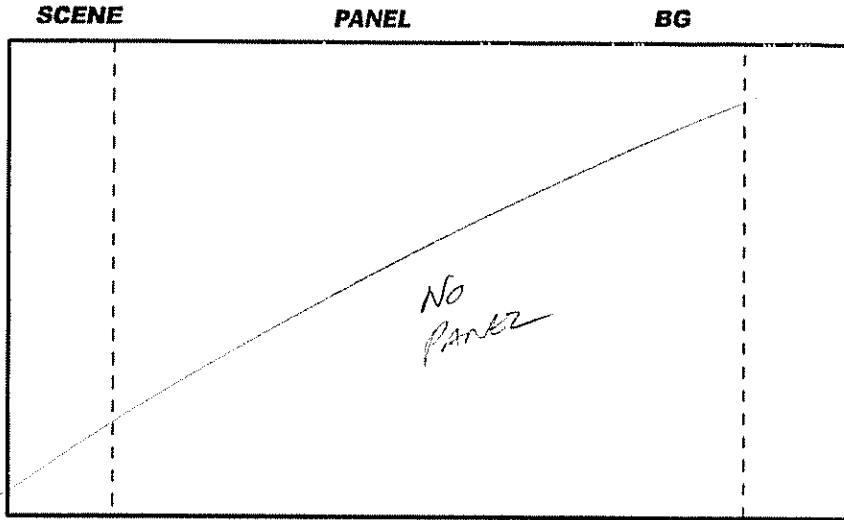

ACTION

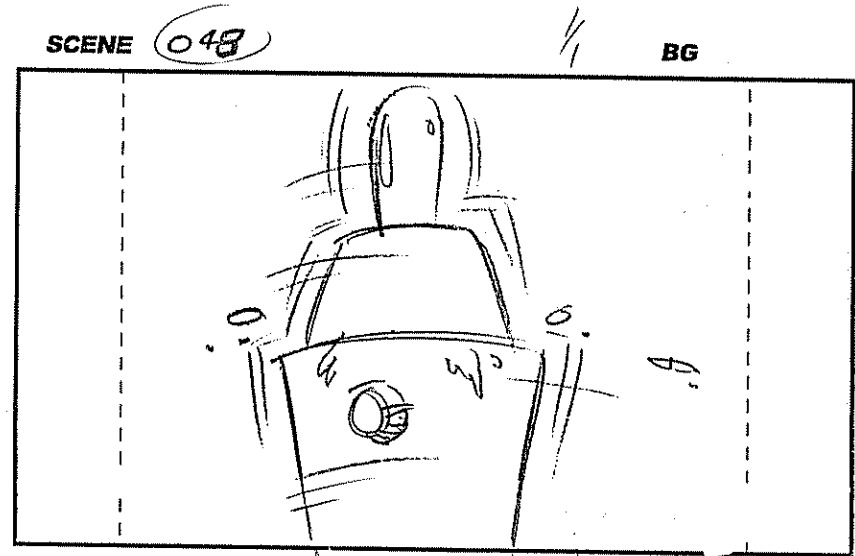

(WIPE IN) →

HOLD ON ICE CREAM MAKER (BACK IN KITCHEN)
SHAKING

DIALOGUE

NOTES

SCENE

Sc# (49)

BG

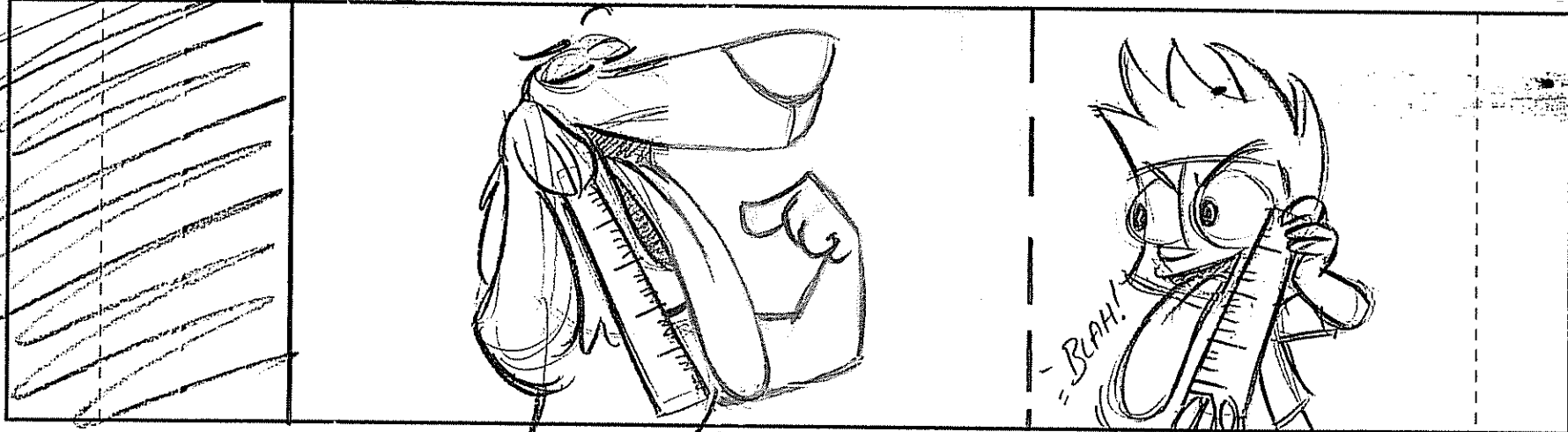

ACTION

(cut)

(B) ←

PAN (A)

THEY COMPARE THE LENGTHS OF THEIR TONGUES --

DIALOGUE

(20) JOHNNY (STRETCHED TONGUE)
MINE'S LONGER!

(21) DUKEY (STRETCHED TONGUE): NO, MINE IS!

NOTES

202B

⊕ PAGE # 48B NEXT!



EPISODE: _____ | PAGE: 048

SCENE 050

BG

SCENE

BG

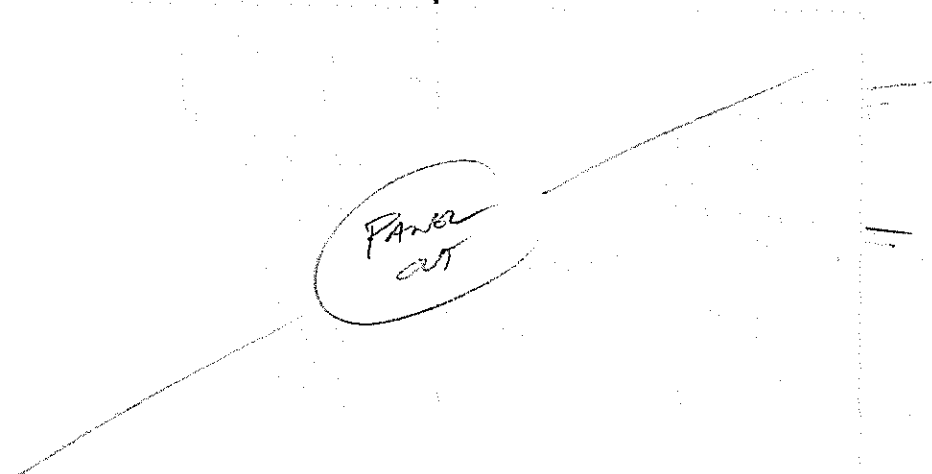
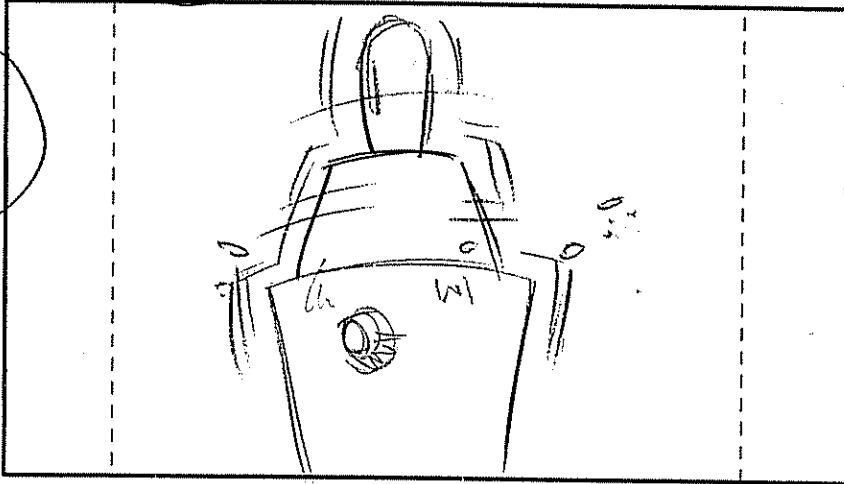

CUT to

ACTION

CUT

ICE CREAM MAKER STILL SHAKING!

DIALOGUE

NOTES



© 2006 Johnny Test Productions Inc. "Johnny Test" TM Warner Bros. Entertainment Inc. All Rights Reserved.

collidescope animation studios

SCENE (51A)

PANEL

BG

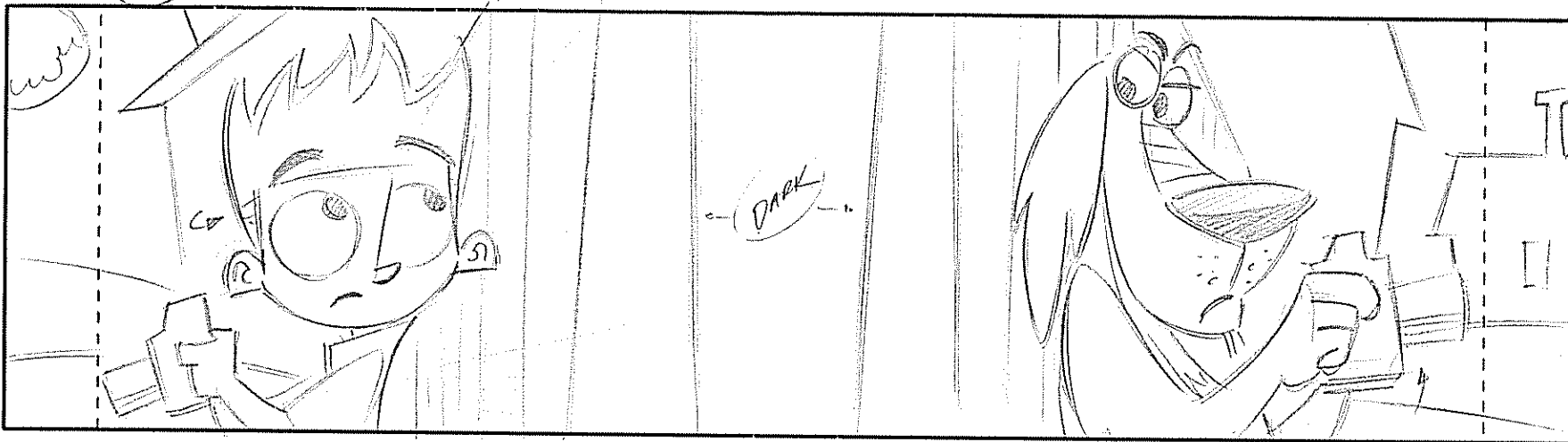

ACTION

START

Panel

STOP

(CUT)

CLOSE UP JOHNNY LEANING AGAINST FENCE ...

- PAN RT THROUGH FENCE ...

- TO DUCK ALSO LEANING ON FENCE (HE RAISES CAMERA)

DIALOGUE

NOTES



12 - PHASES

202 B

⊕ PAGE # 49 F NEXT!

PAGE: 49C

SCENE

51B

PANEL

1/2

BG

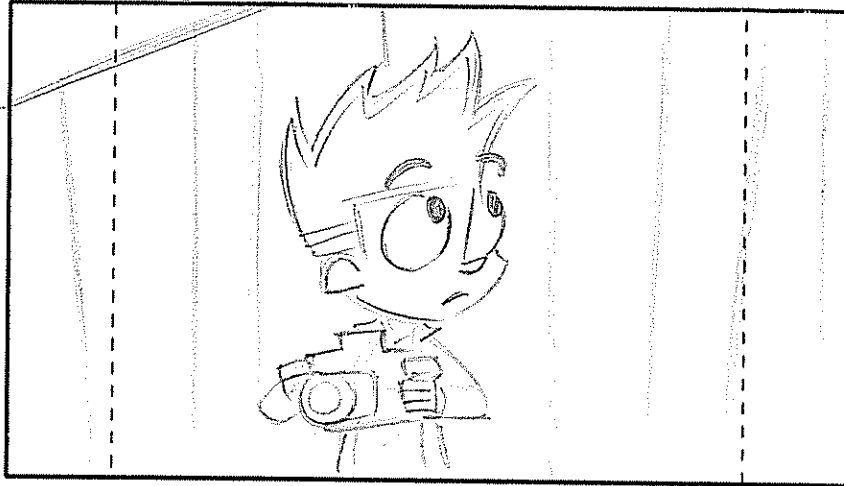

PANEL OUT

ACTION

WT

BK to Johnny.

DIALOGUE

NOTES





RE - PG'S 49D, 49E out! 202 B
 - SC SID out!
 - SC SID out!

4 PAGE # 49G, NEXT!

PAGE: 49F

RE - SC#
 - PANELS
 - ACTION

PANEL OUT!

SCENE SLB CONT'D PANEL 2/2 BG

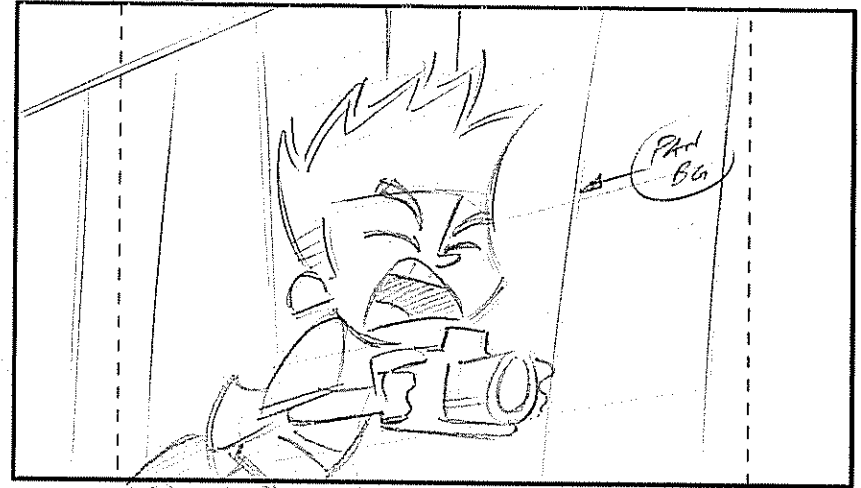

ACTION

Johnny Running IN SLO-MO!
 (DIRTY PAN BG!)

DIALOGUE

Johnny = (SLO-MO)
 AAAHHH!!!

NOTES



SCENE (S1E)

PANEL

BG

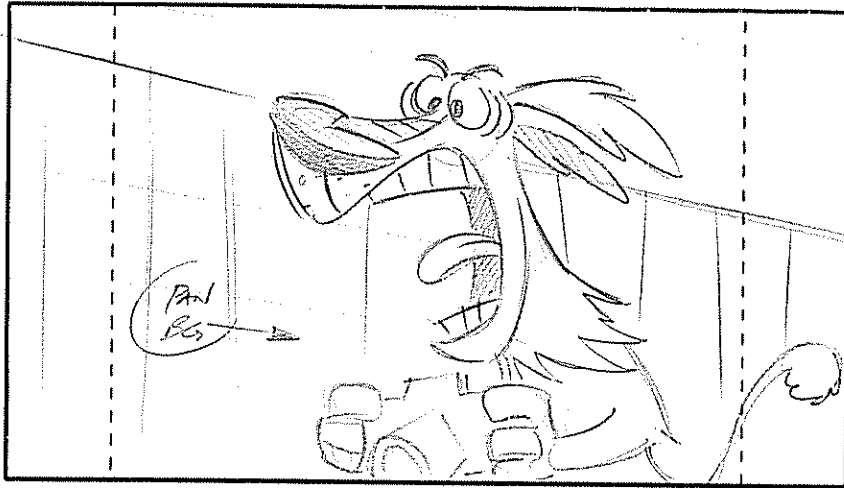

SCENE

PANEL

BG

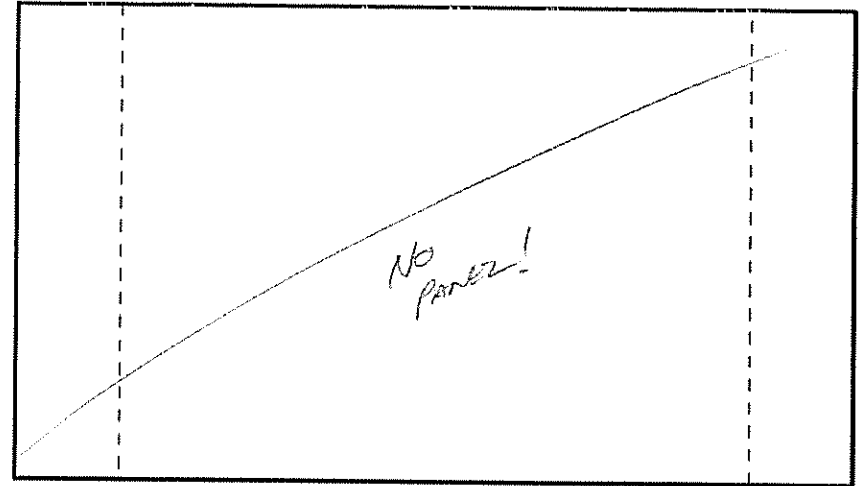

ACTION

(W) To Duff running in (SLO-MO!)
(DUE-PAN BG!)

DIALOGUE

DUE! = (SLO-MO)
AHHH!!!

NOTES

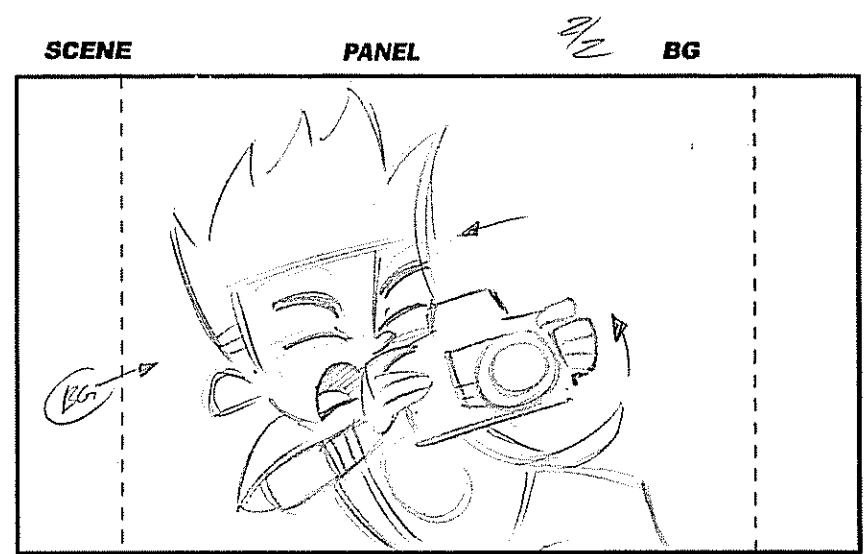
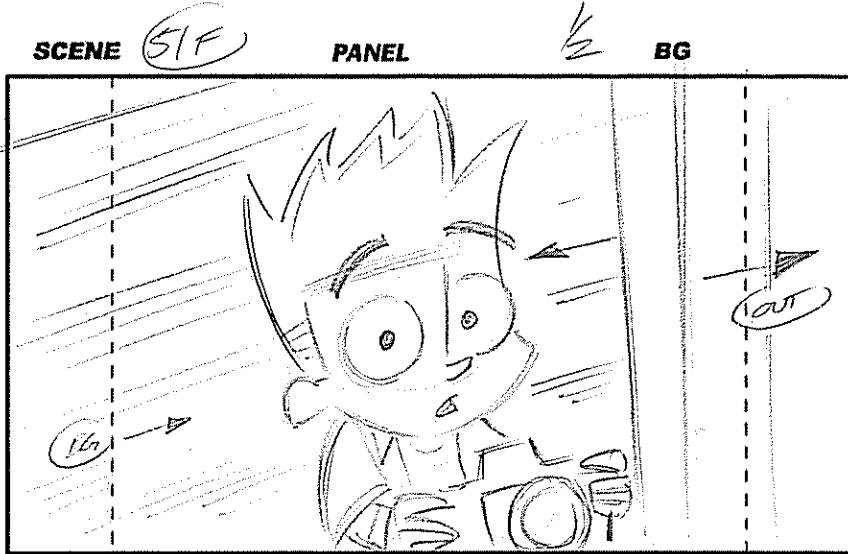

ACTION

(CUT) Johnny GAINS (PAN) AS
FENCE PANS OUT (SLO-MO!)
(-BG ZIP PAN)

Johnny RAISES CAMERA (SLO-MO!)

DIALOGUE

DUKEM : (CONT O.S.)
(SCREEN)

Johnny : (SLO-MO)
ERRR!!!

NOTES

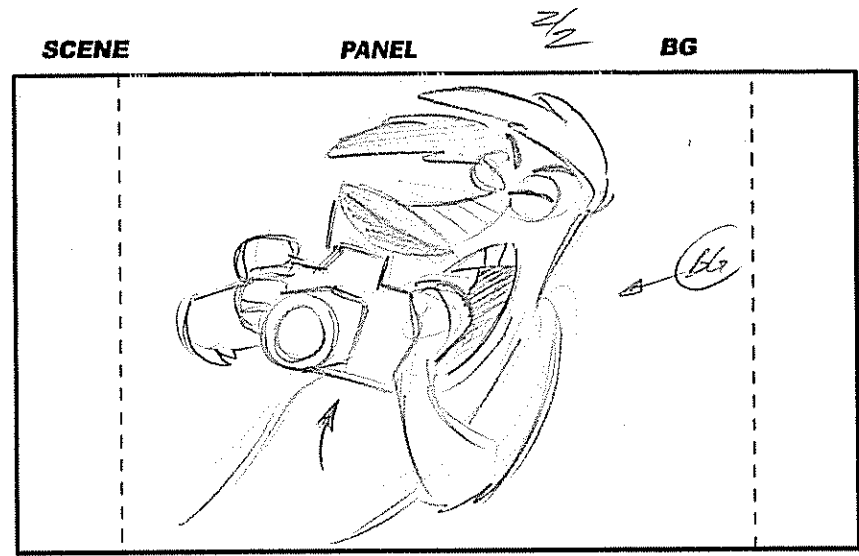
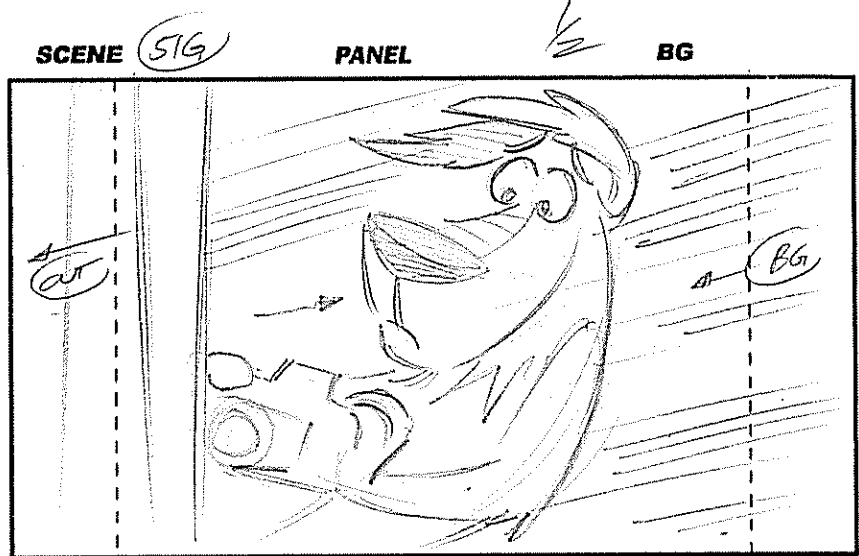

ACTION TO DUKEY IN SLOW-MO GAINING TO & AS FENCE PASSES OUT (BG ZIP PAN)

DUKEY RAISES CAMERA IN SLOW-MO!

DIALOGUE

NOTES



202B

⊕ PAGE # 49K NEXT!

PAGE: 49J

(12) - PANELS

(12)
PANEL OUT!

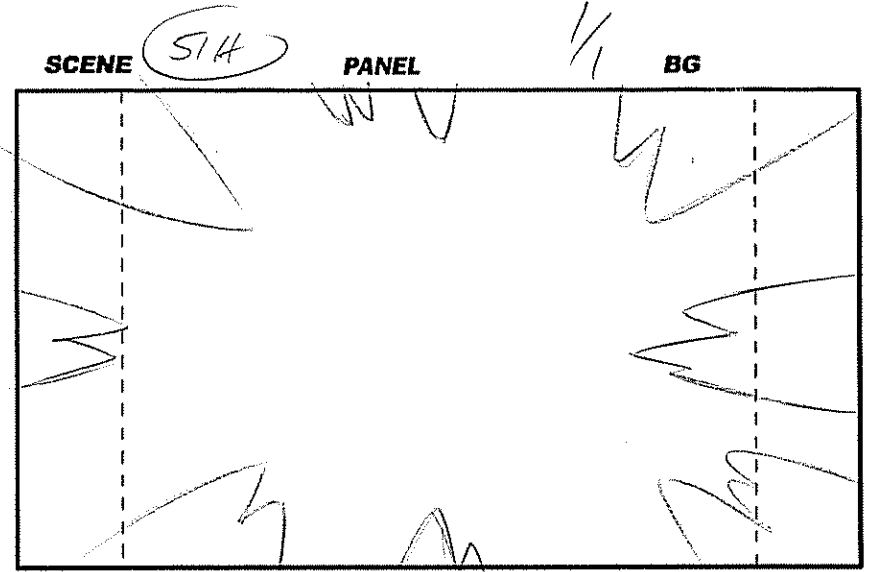

(12) POST PROD 1x FLASH!

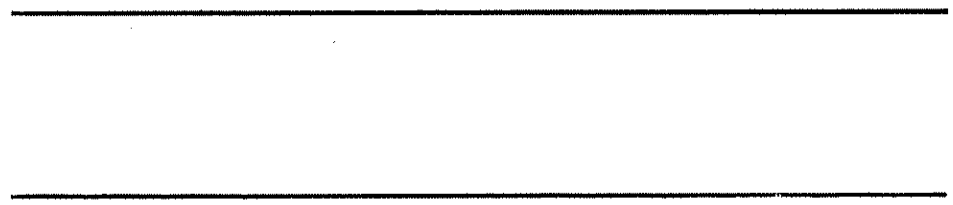

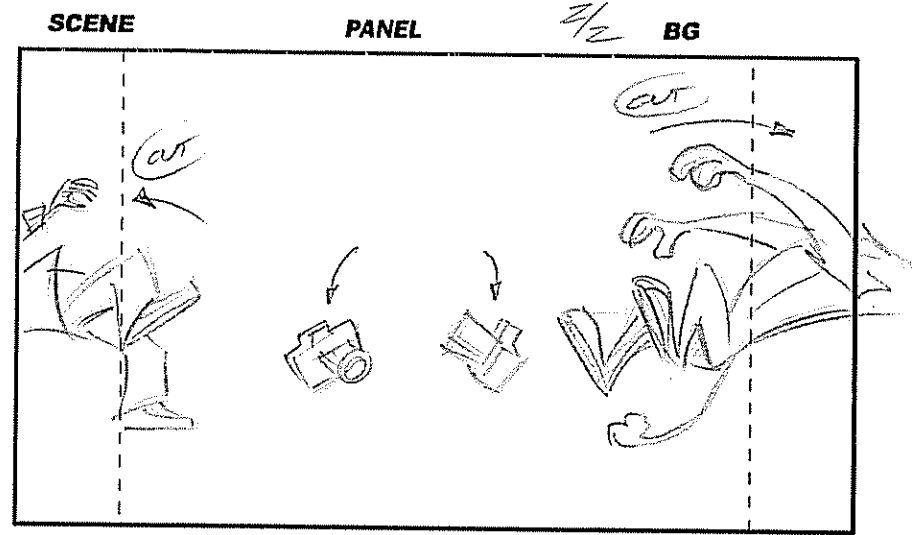
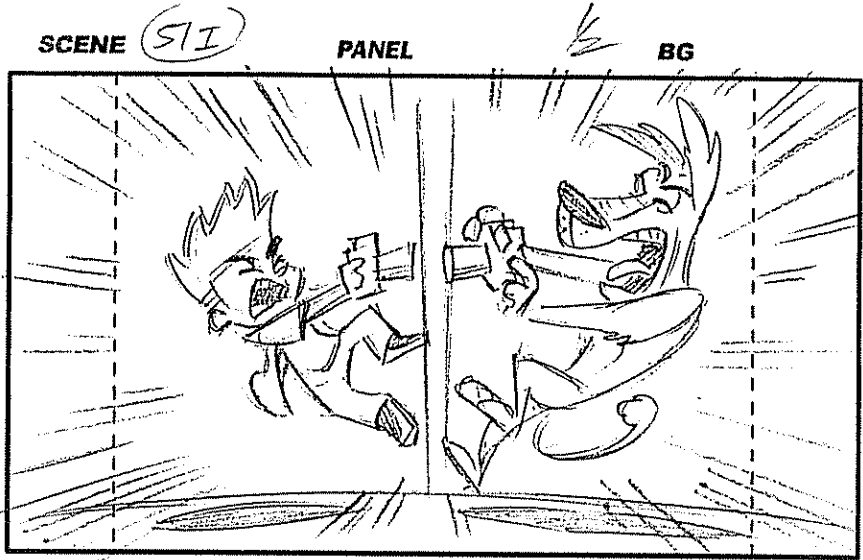

ACTION

(CUT) BACK TO FREEZE FRAME OF
Johnny & Duke
(CYCLE FORCE LINES)

- Johnny & Duke Fall d/s
(NORMAL SPEED!)

DIALOGUE

Johnny/Duke - (ADR)
MY EYES!

NOTES

203B



EPISODE: _____ PAGE: ~~050~~ 050

SCENE 052

BG

Panel
cut!

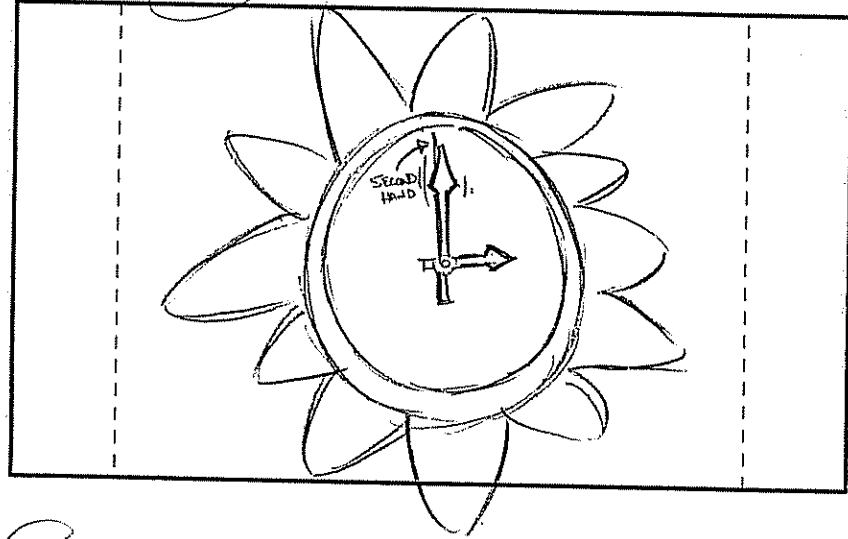

CS

DIALOGUE

NOTES



© 2006 Johnny Test Productions Inc "Johnny Test" TM Warner Bros Entertainment Inc. All Rights Reserved.

collidescope animation studios

202B



EPISODE: _____

PAGE: 051

(R2) - VIS
- ACT

SCENE 053

BG

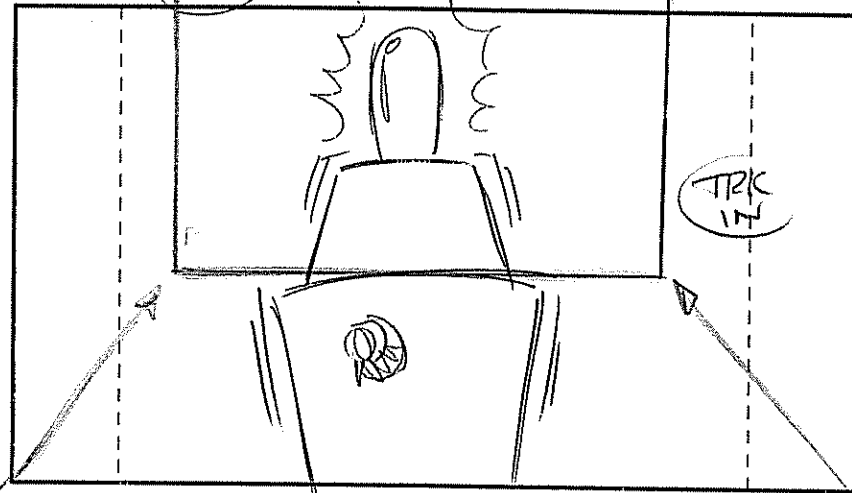

Panel cut!

ACTION

- ICE CREAM MAKER SHUDDERS TO A STOP
- GREEN LIGHT FLASHES
- TRK-IN ON LIGHT

DIALOGUE

SFX:

(beep, beep, beep!)

NOTES



© 2006 Johnny Test Productions Inc "Johnny Test" TM Warner Bros Entertainment Inc All Rights Reserved

collidescope animation studios

(R2)



202B

⊕ PAGE # 52A NEXT!

EPISODE: _____

PAGE: 52

(RZ) -DIAL.

SCENE (54)

1/2 BG

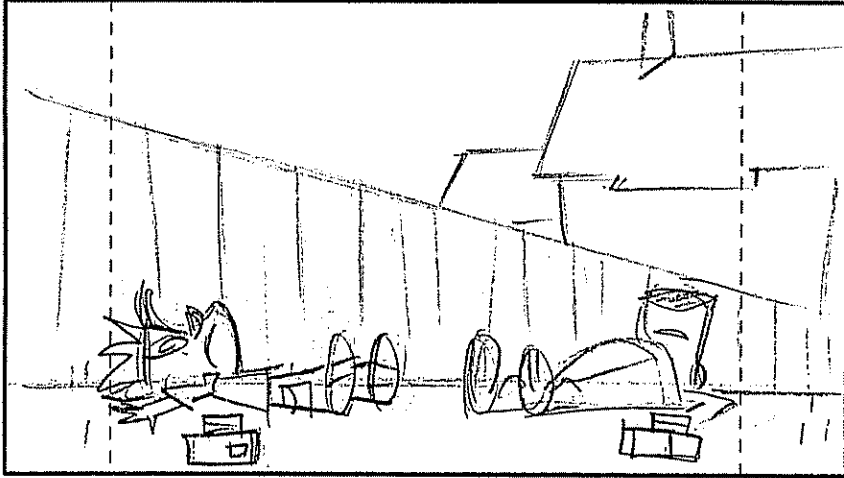

SCENE

2/2 BG

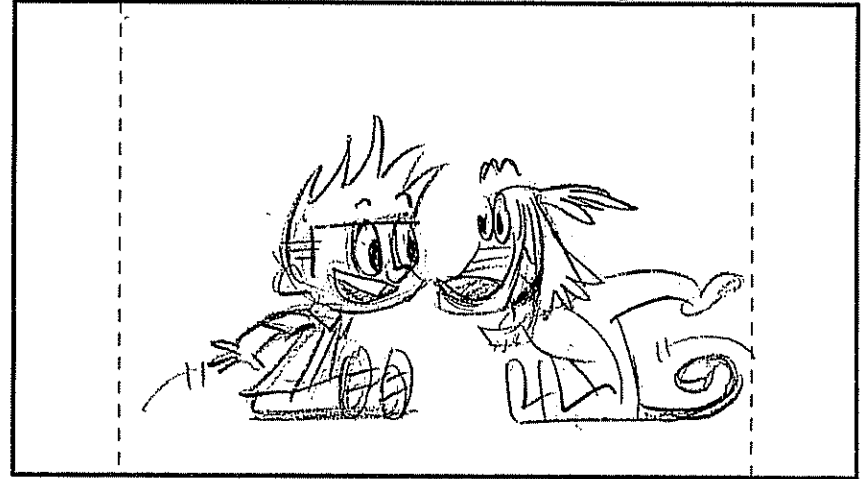

ACTION

To Johnny & Doreen sitting at
ground.

(W)

THEY SIT UP.

DIALOGUE

SFX: (d/s)
(ICE CREAM MAKER)

(RZ) JOHNNY:
OH SUPER TASTY,
HOME MADE, MEGA-MINT CHIPS...

NOTES



© 2008 Johnny Test Productions Inc. "Johnny Test" TM Warner Bros. Entertainment Inc. All Rights Reserved.

collidescope animation studios

(R2) - DML

(R2) - DML

SCENE 55

1/3 BG

SCENE

2/3 BG

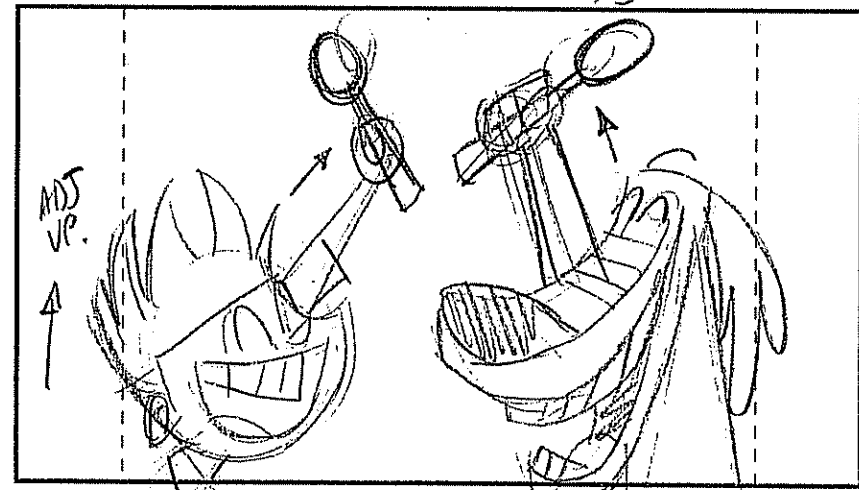
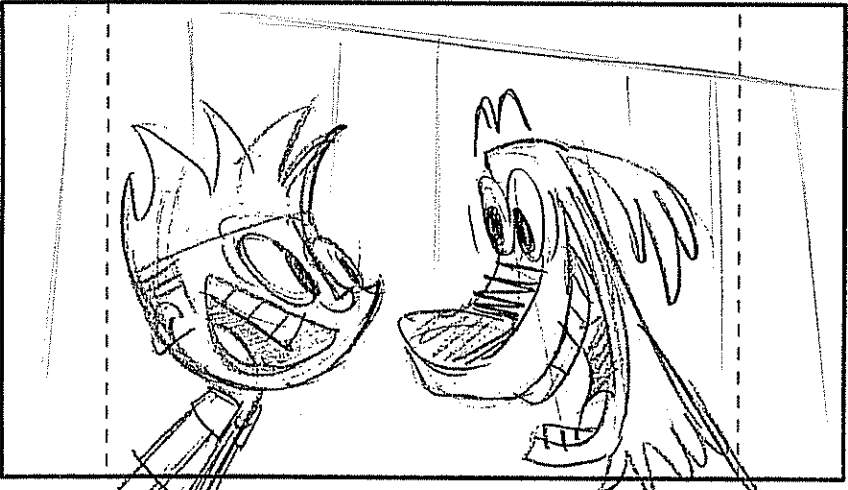

ACTION

Closer and Johnny & Duke

↑
↑
 - THEY RACE THEIR SPOONS
 - PAN UP TO ADJUST

DIALOGUE

JOHNNY: (CONT)
 ... DONE!

J & D: (ADR)
 TO THE ICE CREAM!

NOTES





202 B

⊕ PAGE # 53A NEXT!

PAGE: 53

SCENE 55 CONFID PANEL 3/3 BG

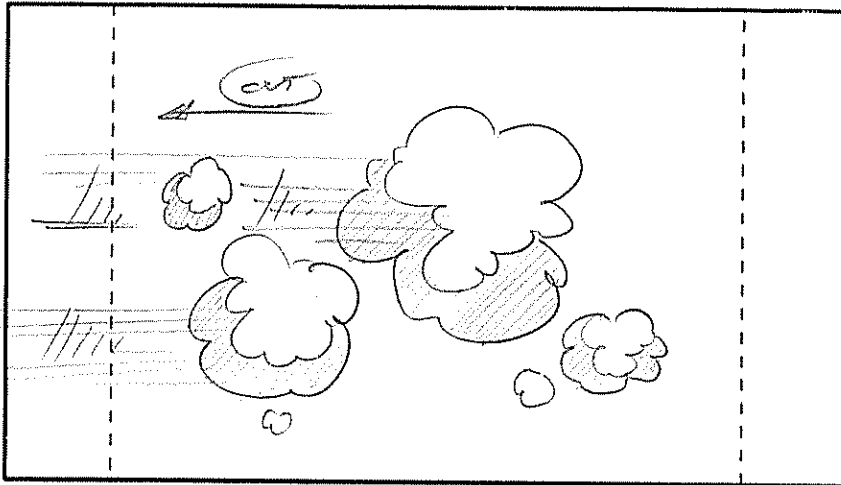

ACTION

THAT ZIP AS IT!

SCENE PANEL BG

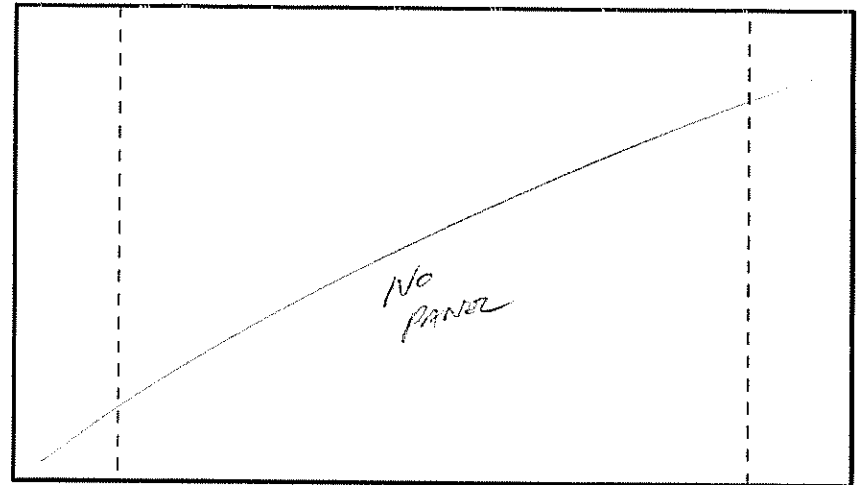

DIALOGUE

NOTES



SCENE

SSA

PANEL

1/2

BG

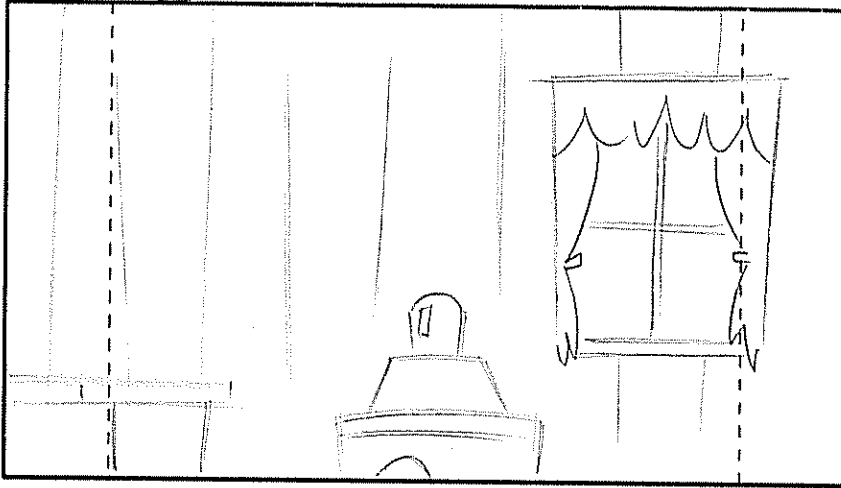

ACTION

(Handwritten initials)

DIALOGUE

NOTES

SCENE

PANEL

2/2

BG

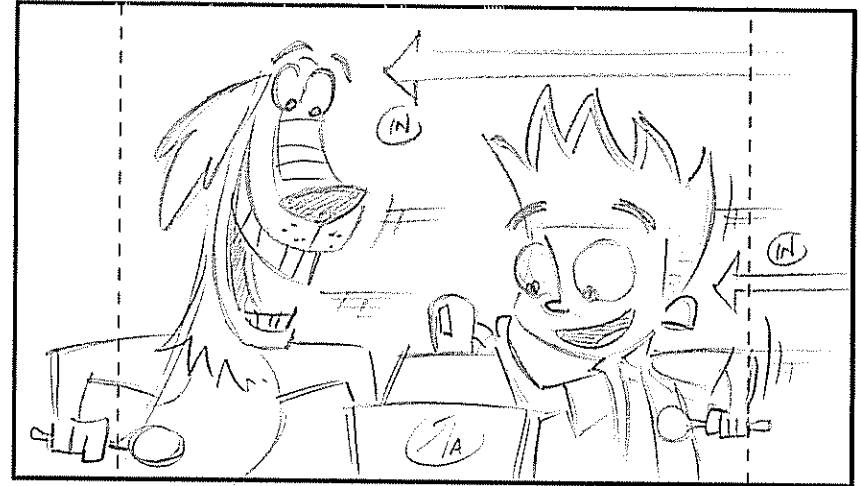

Draw of Johnny zip in!

SCENE (56)

PANEL 1/2

BG

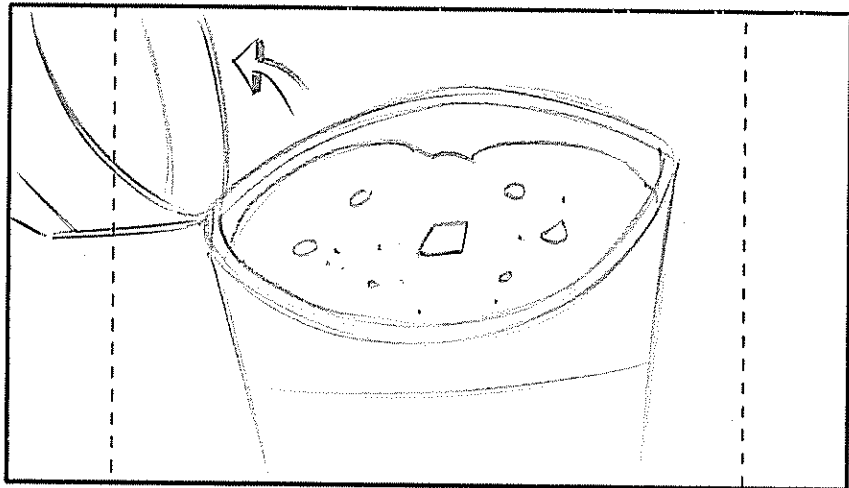

ACTION

(cut)

Johnny opens lid.

SCENE

PANEL 2/2

BG

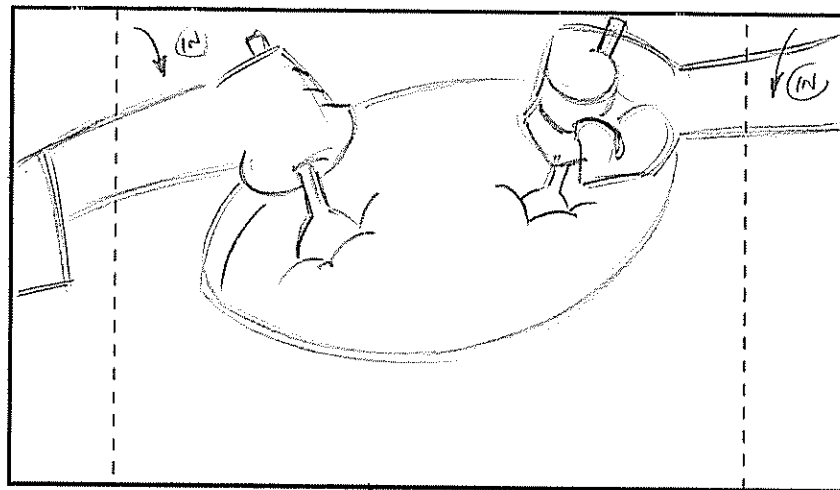

Johnny & Duff's hands IN WITH SPOONS.

DIALOGUE

NOTES

SCENE (56A)

PANEL

1/4

BG

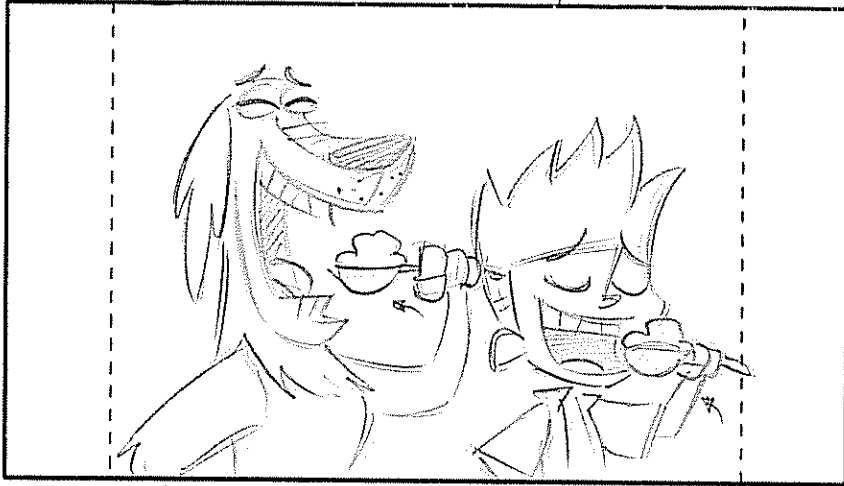

ACTION

TO JOHNNY & DALEY WITH SPOONS
TO THEIR MOUTHS

SCENE

PANEL

2/4

BG



THEY STICK SPOONS INTO MOUTHS.

DIALOGUE

SFX:
(Chompings!)

NOTES



202 B

PAGE: 534

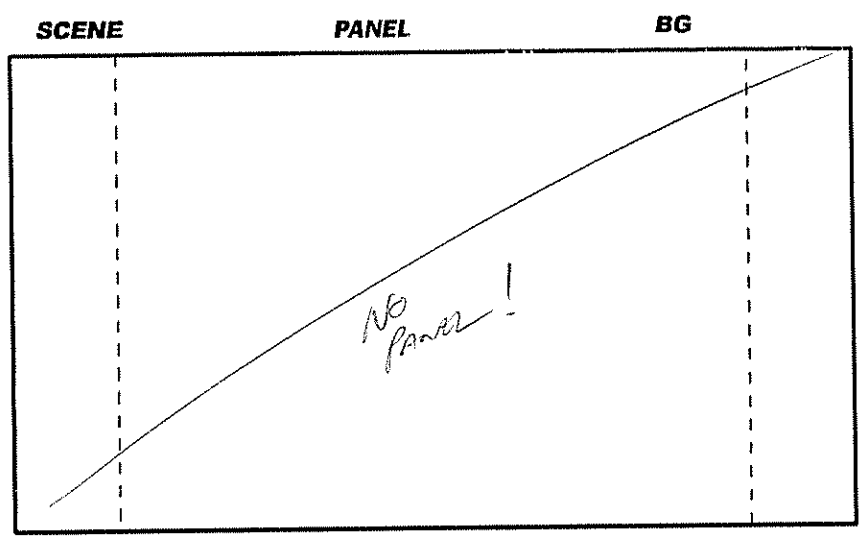

ACTION

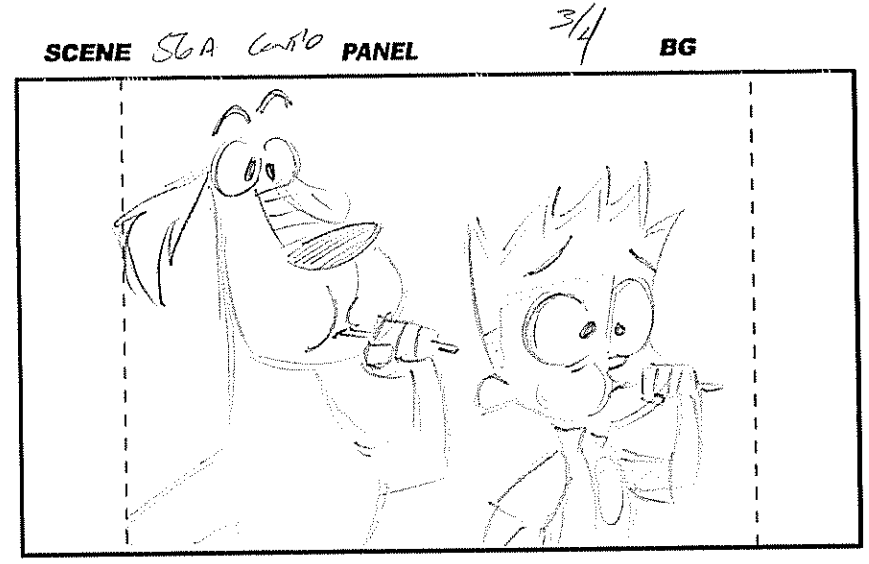

They React!

DIALOGUE

NOTES



2023



(R2) - VIS
- ACTION

SCENE 56A cont'd 4/4 BG

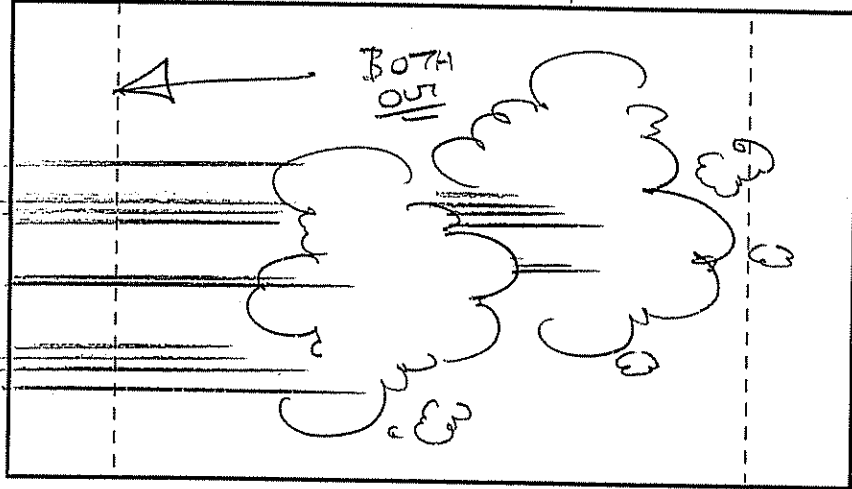

ACTION

BOTH ZIP AWAY!

SCENE 057 BG



(cut) TO JOHNNY & DUKEY
- JOHNNY IS SPRAWLING HIS MOUTH
- DUKEY IS BAWLING HIS MOUTH

DIALOGUE

23. JOHNNY/DUKEY
AHHHHH!!!

NOTES



2028



RE - VIS
- portrait

EPISODE: _____ PAGE: 057

SCENE (058)

1/4

BG

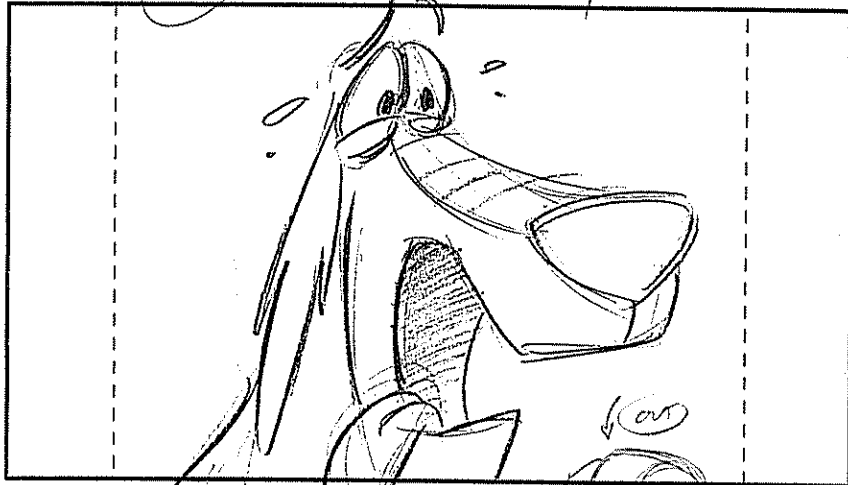

ACTION

CR

DUKEY'S HAND OUT.

SCENE

2/4

BG

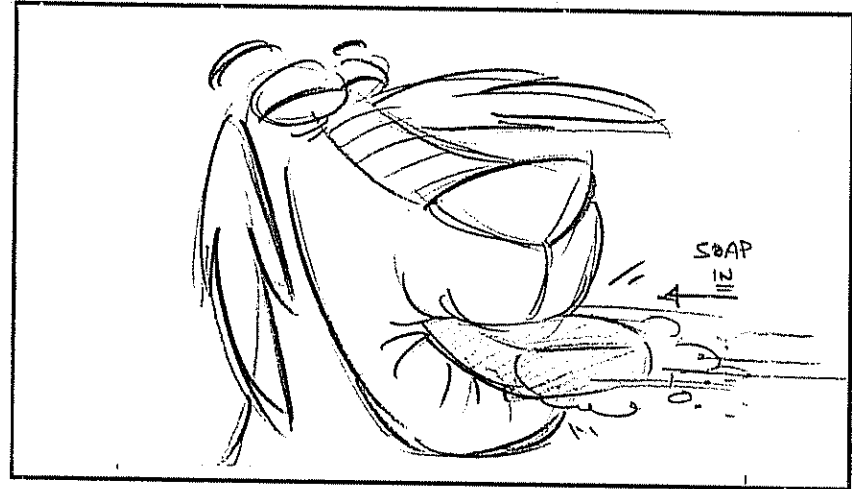

DIALOGUE

24. DUKEY
Soap, I need soap!

NOTES



© 2006 Johnny Test Productions Inc "Johnny Test" TM Warner Bros Entertainment Inc All Rights Reserved

collideascope animation studios



202B

RE PAGE # 058A NEXT!

EPISODE: _____ PAGE: 058

RE-US.

SCENE

58 cont'd

3/4

BG

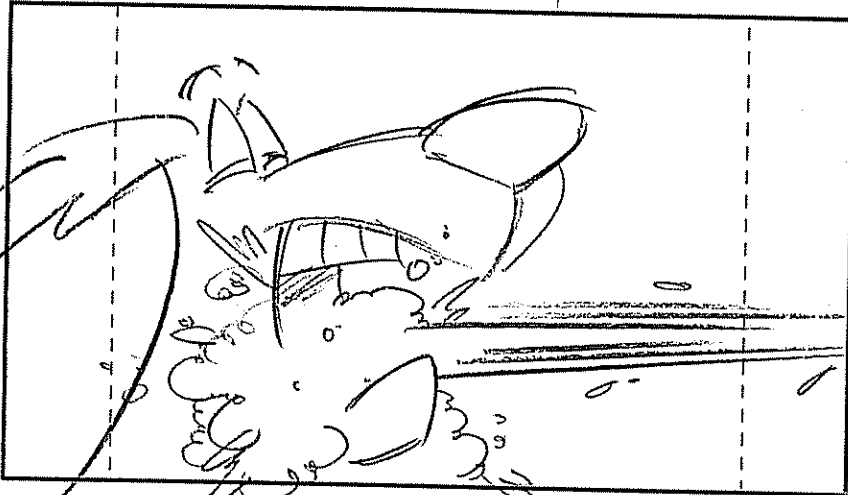

ACTION

SCENE

4/4

BG

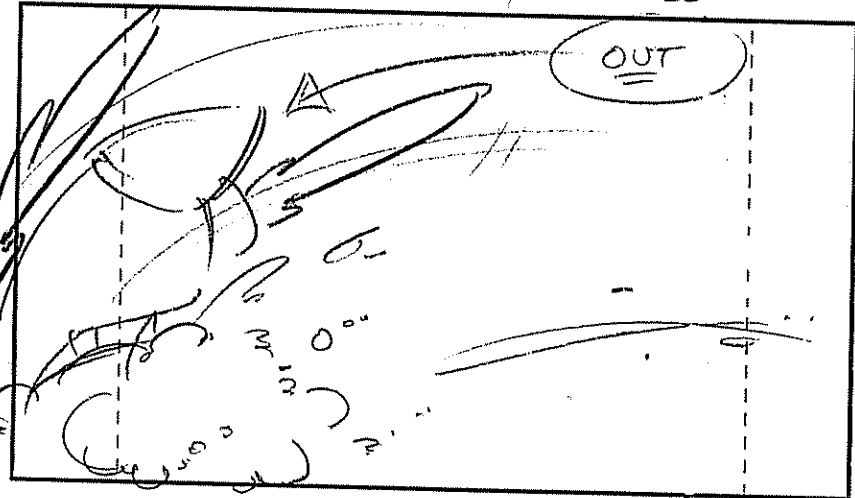

DIALOGUE

NOTES



© 2006 Johnny Test Productions Inc "Johnny Test" TM Warner Bros Entertainment Inc. All Rights Reserved.

collidescope animation studios

RE



202B

(P2) - NEWS PAGE
+ PAGE #58B NEXT!

PAGE: 058A

-PANELS
(P2) - VIS
- DIAC

(P2) - VIS
- DIAC

SCENE 058

PANEL

1/4

BG



SCENE

PANEL

2/4

BG



ACTION

(W) To Johnny & Dog on FLOOR...

Johnny looks AT ICE CREAM MAKER.

DIALOGUE

(25) JOHNNY:
NO WONDER PEOPLE DON'T USE
THESE THINGS - ...

NOTES



(P2)



RE - VIS/NEW PANEL

202B

RE - VIS/NEW PANEL!

PAGE: 58B

RE - VIS/NEW PANEL

SCENE 59 CONT'D PANEL

3/4

BG



ACTION

JOHNNY RAISES FOOT TO MARKER.

SCENE

PANEL

4/4

BG

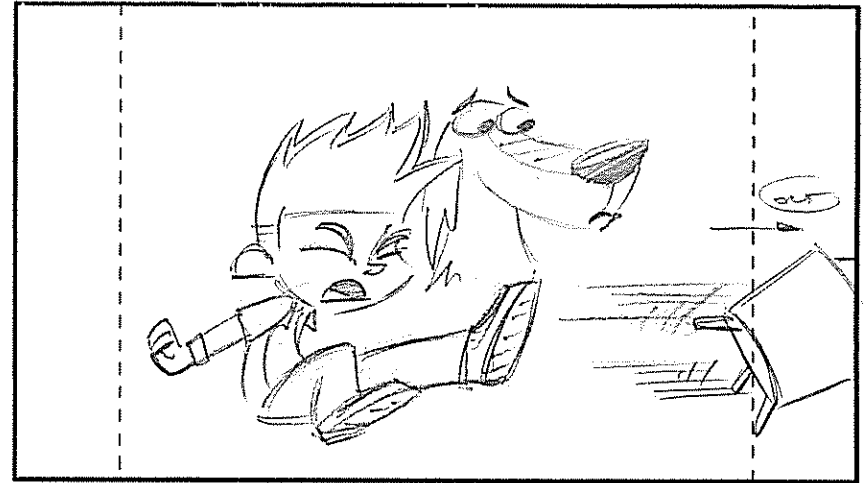

JOHNNY KICKS MARKER OFS RT!

DIALOGUE

(25) JOHNNY: (CONT'D)
THEY'RE...

JOHNNY: (CONT)

...EVIL!

NOTES





2025

(R2) - PANEL SKIPT.

EPISODE: _____

PAGE: 059

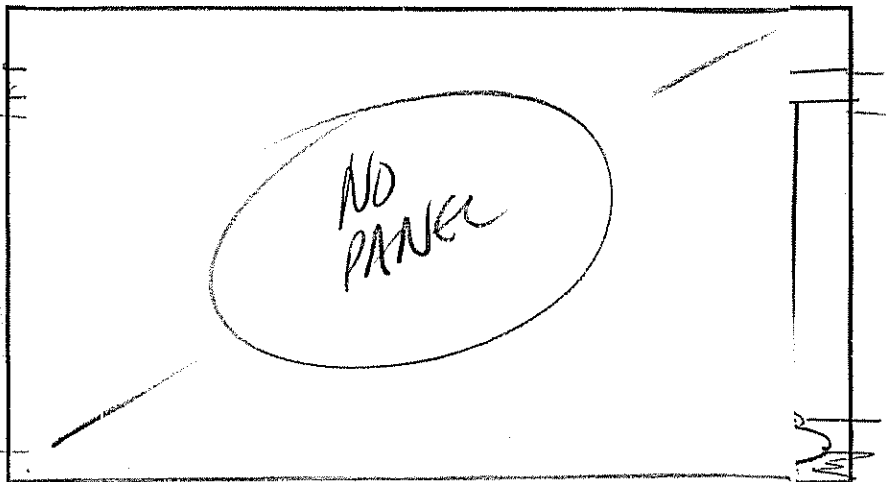

SCENE (060)

BG



(CB) Close up Dukey

DIALOGUE

26. DUKEY
And we're still out of ice cream.

NOTES



© 2006 Johnny Test Productions Inc "Johnny Test" TM Warner Bros Entertainment Inc All Rights Reserved

collidescope animation studios

(R2)

202 B

PAGE# 60A NEXT!



RE-DRAW

EPISODE: _____

PAGE: 060

(R2) - DIAL

SCENE (061)

BG

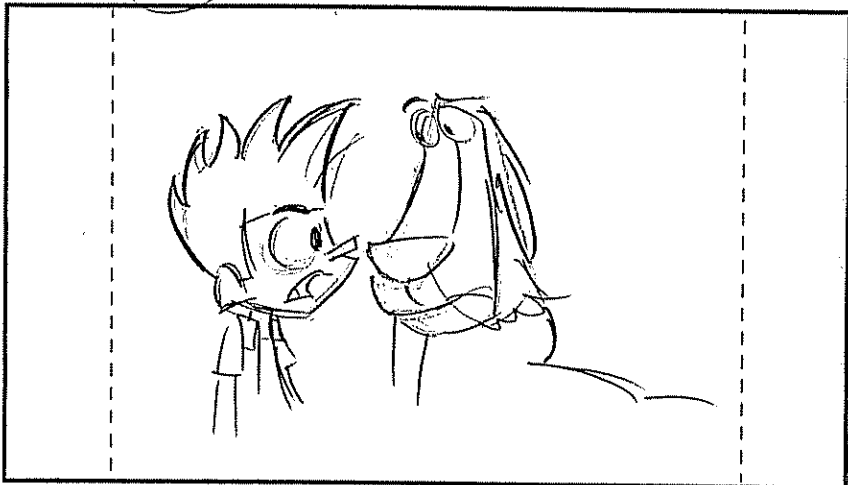

SCENE (62)

BG

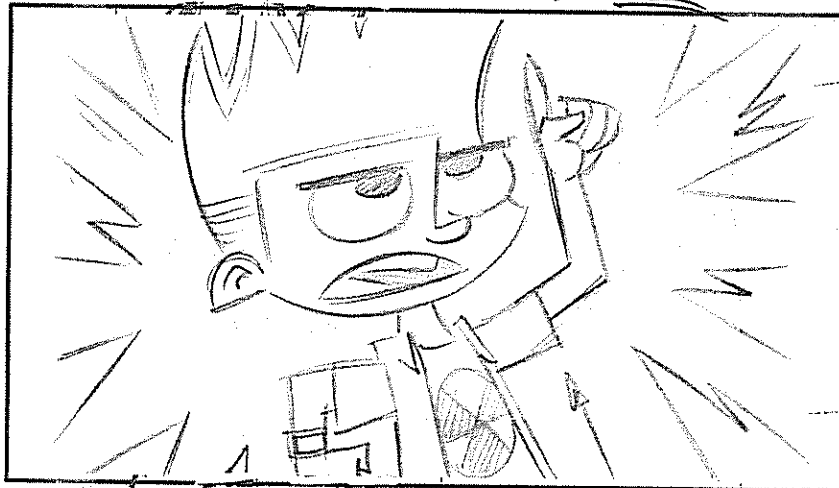

ACTION

BACK to Johnny & DUCK on FLOOR.

(CUT)

(CUT)

Johnny RISES INTO SHOT.

DIALOGUE

27. JOHNNY
Well, if Dad won't buy more,
we'll just have to buy it ourselves.

JOHNNY (CONT)
To the first national
bank of...

NOTES



© 2006 Johnny Test Productions Inc "Johnny Test" TM Warner Bros Entertainment Inc. All Rights Reserved.

collide@scope animation studios

(R2)



R2 - NEW PAGE.

PAGE: 060A

R2 - NEW PANEL

SCENE 62 CONT'D. PANEL 2/2 BG

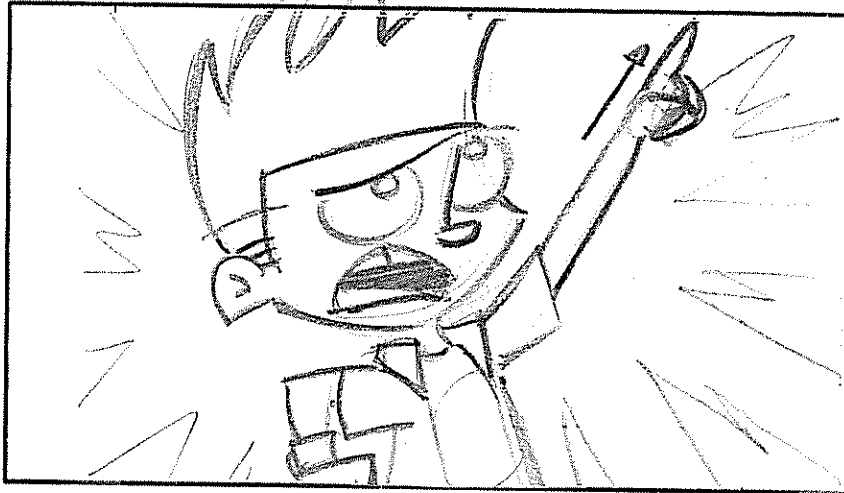

ACTION

SCENE PANEL BG

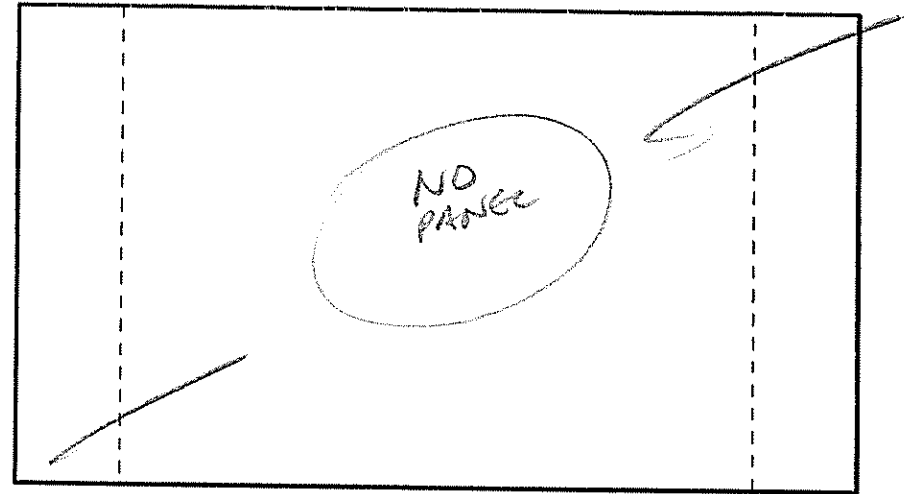

DIALOGUE

JOHNNY: (CONT)

... MY SISTERS!

NOTES



R2



*NO SC 63!

202 B

⊕ PAGE # 61A NEXT!

EPISODE: _____ | PAGE: 061

(R3) - VIS

SCENE

(62A)

1/1

BG

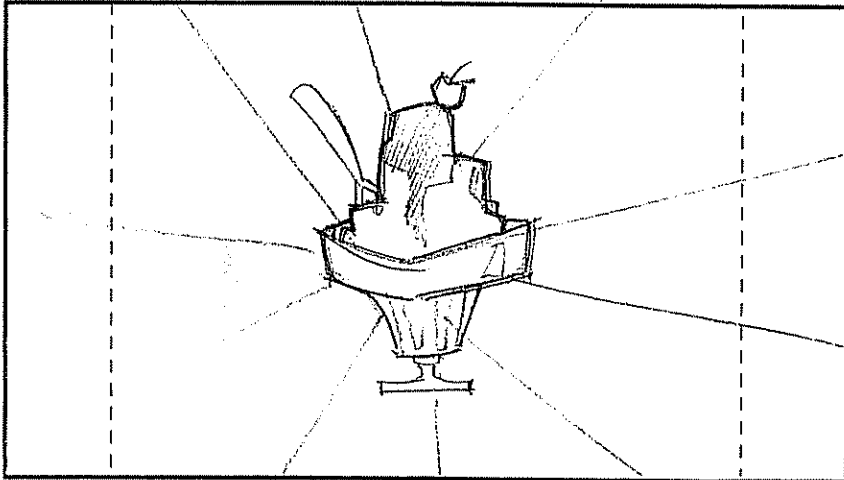

ACTION

ICE CREAM WAPE →

DIALOGUE

NOTES



© 2006 Johnny Test Productions Inc "Johnny Test" TM Warner

SCENE

(064)

1/3

BG

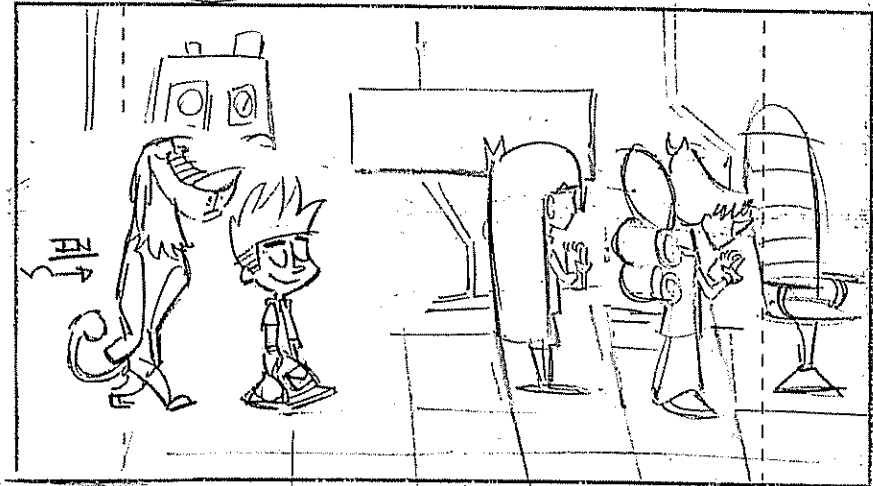

(WAPE IN)

TO INT. LAB...
- Johnny & Dingo walk in
(BEHIND GIRLS)

(R3)-VIS

SCENE 64 aria PANEL 2/3 BG

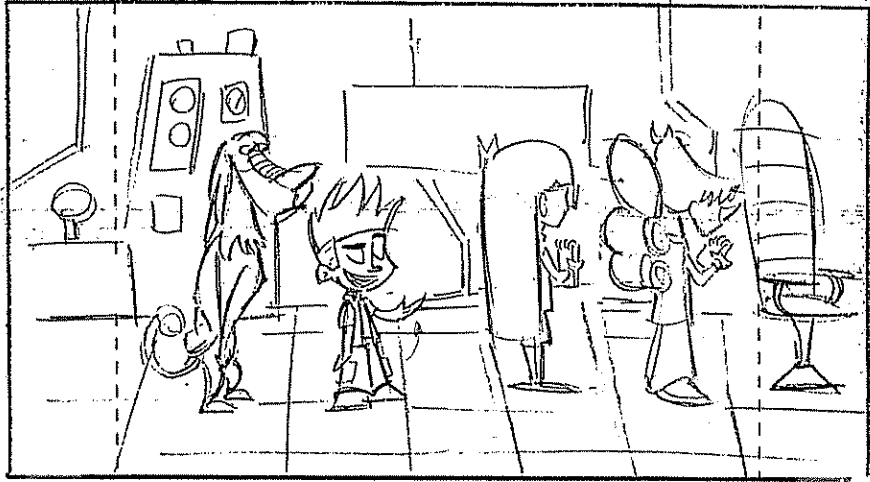

ACTION

Johnny & Dad settle.

SCENE PANEL BG

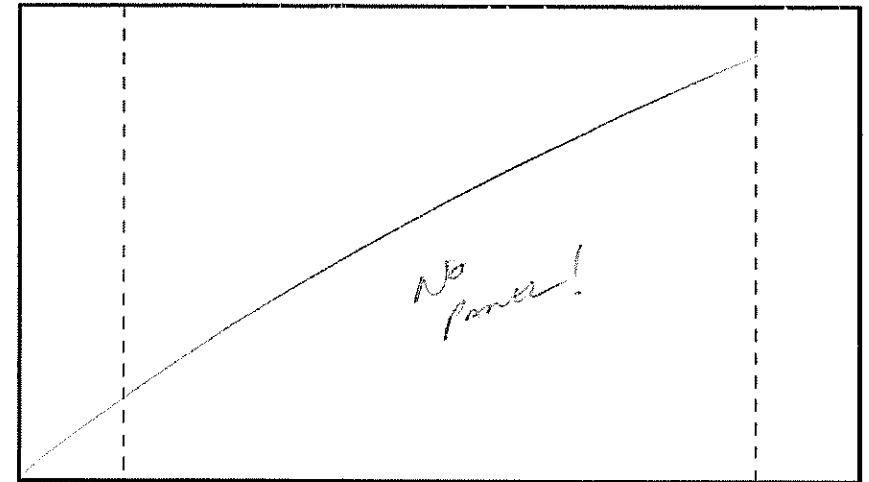

DIALOGUE

(28) *Johnny*
WHO WANTS TO GIVE ME MONEY?

NOTES

(R3-VIS)

SCENE 64 cont'd 2/3 BG

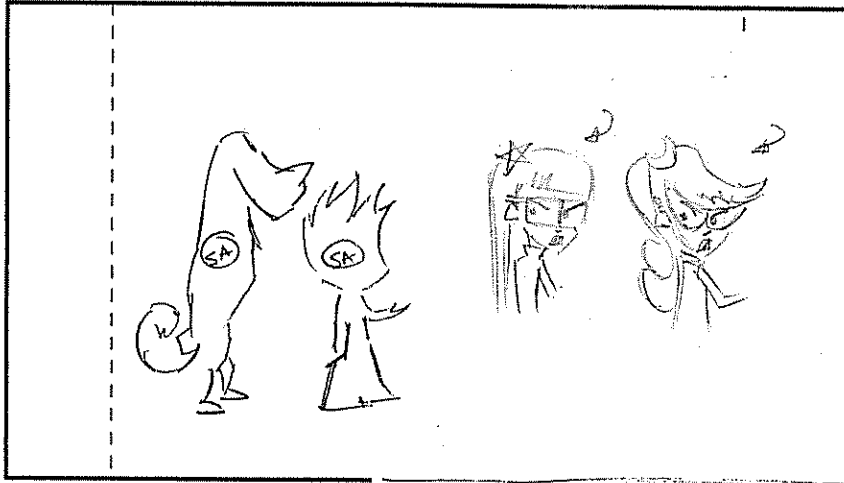

ACTION Mary & Susan Turn Their Heads

SCENE (065) 1/3 BG

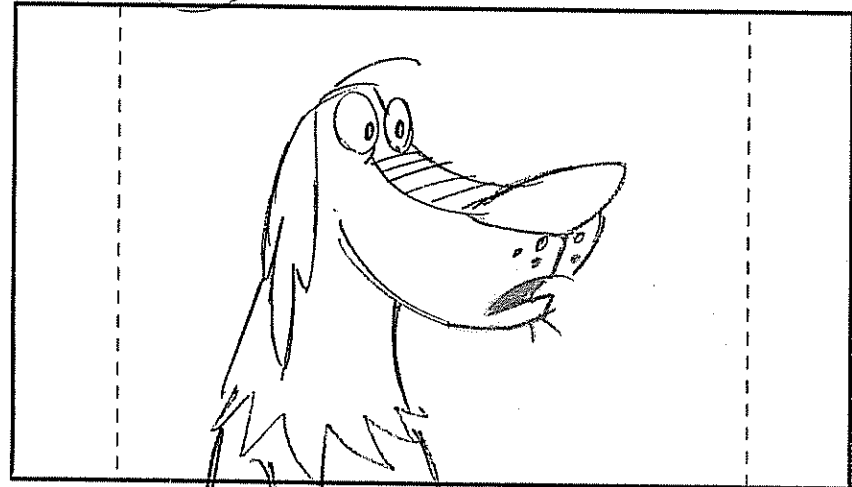

(cut) Close on Duxey.

DIALOGUE

29. SUSAN AND MARY
Go away Johnny.

30 Duxey
B...B...But

NOTES



202B



EPISODE: _____

PAGE: 063

SCENE 65 CONT'D 2/3 BG

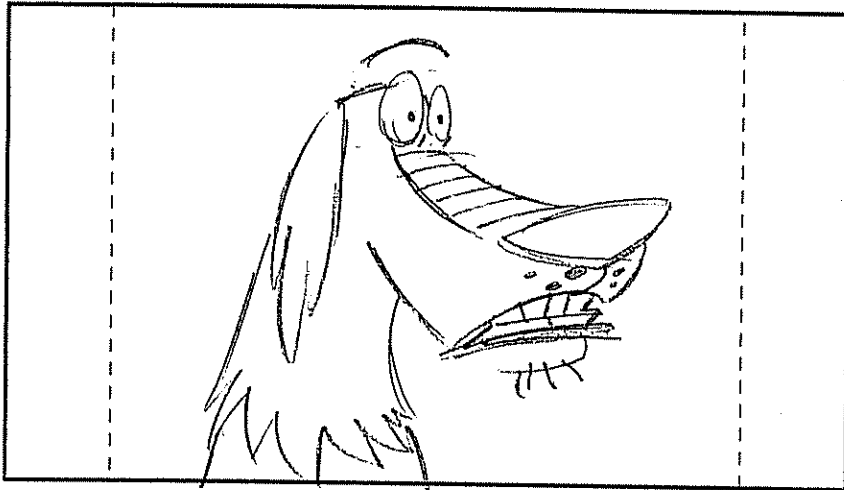

ACTION

SCENE 3/3 BG

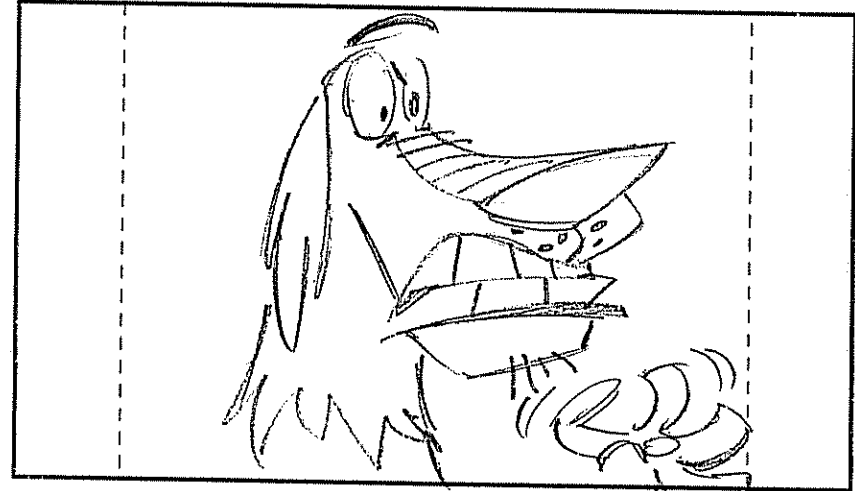

DIALOGUE

30. DUKEY
we need Mint Chip

(Cont'd)

Ice Cream.

NOTES



© 2006 Johnny Test Productions Inc "Johnny Test" TM Warner Bros Entertainment Inc. All Rights Reserved

collidescope animation studios

2025



SCENE 066

1/2

BG



SCENE

2/2

BG



ACTION

(AR) To Susan & Mary

DIALOGUE

31. SUSAN:
Then you're in luck.

32. MARY:
For home ec, we're developing a healthy ice cream substitute, full

NOTES



2023



EPISODE: _____ PAGE: 065

SCENE 066 cont'd

3/3

RG

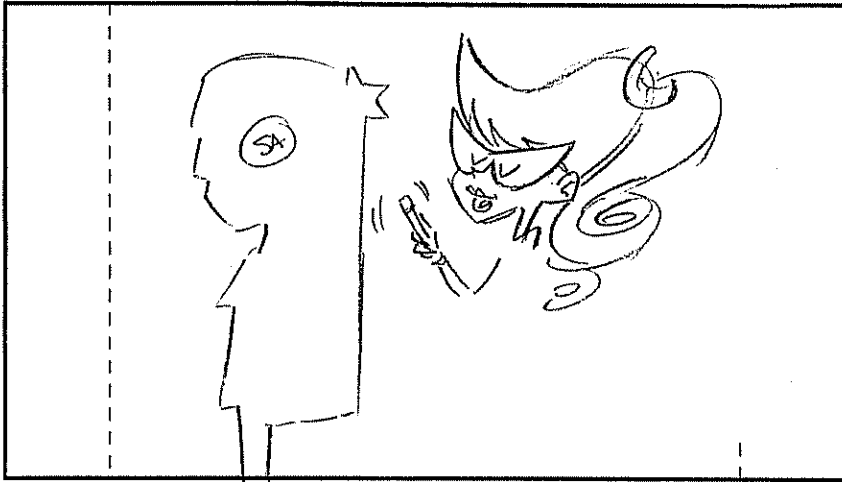

ACTION

SCENE 067

1/4

BG

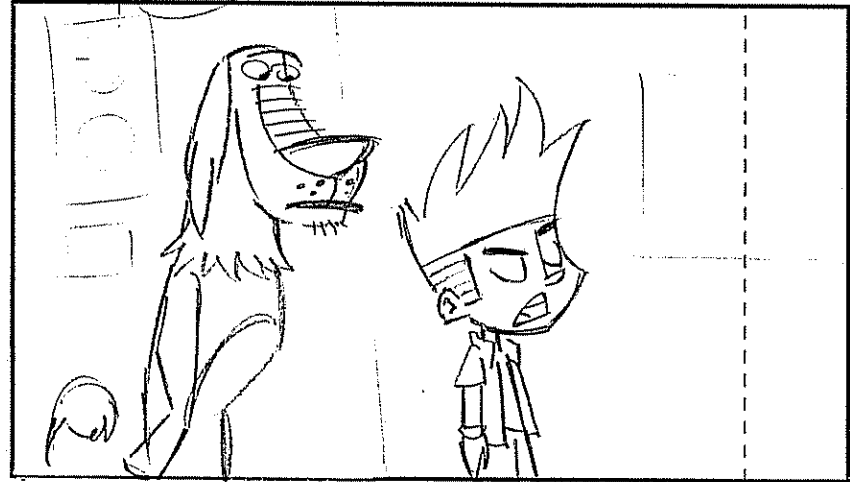

Car To Diner & Johnny

DIALOGUE

MARY: (CONT)
... of vitamins, so kids get nutrition from tasty frozen treats.

33. JOHNNY :
Blah,

NOTES



© 2006 Johnny Test Productions Inc "Johnny Test" TM Warner Bros Entertainment Inc. All Rights Reserved

collideoscope animation studios

2023



EPISODE: _____ | PAGE: 066

SCENE

67 cont'd

2/4

BG

SCENE

3/4

BG

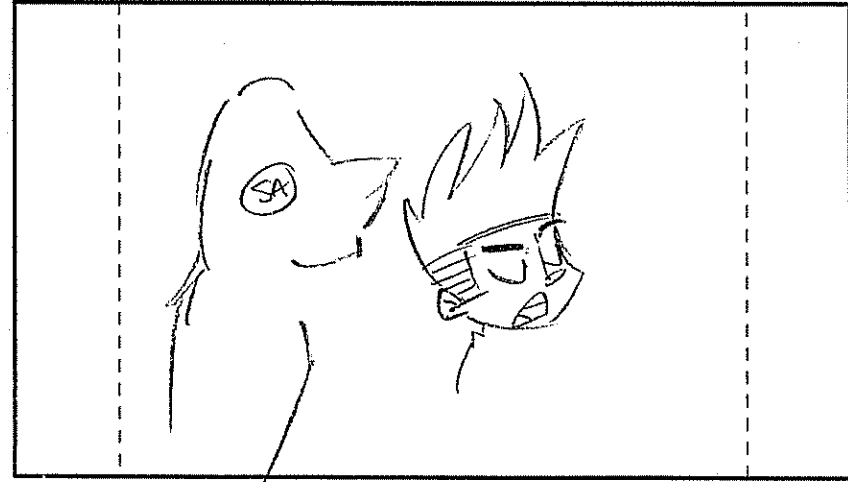
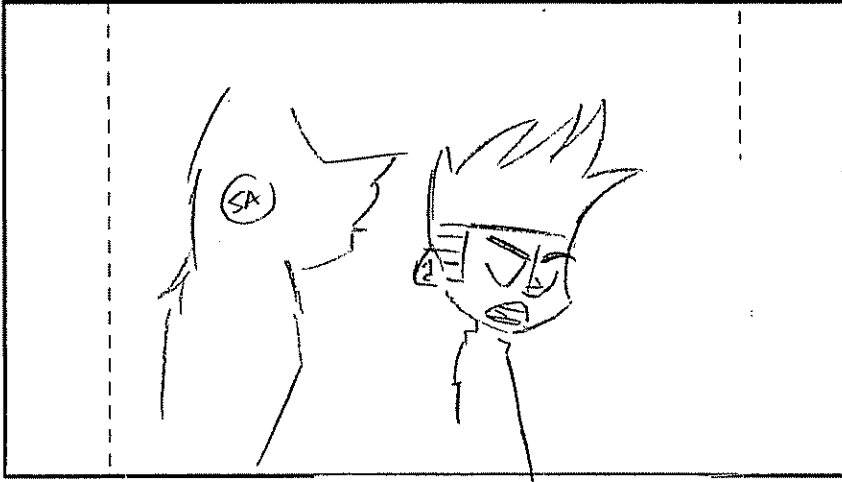

ACTION

DIALOGUE

(22) Johnny (cont'd)
BLAH

BLAH

JOHNNY (CONT)

NOTES



© 2006 Johnny Test Productions Inc. "Johnny Test" TM Warner Bros Entertainment Inc. All Rights Reserved

collidescope animation studios

2023



EPISODE: _____ PAGE: 067

SCENE

67 cont'd

4/4

BG

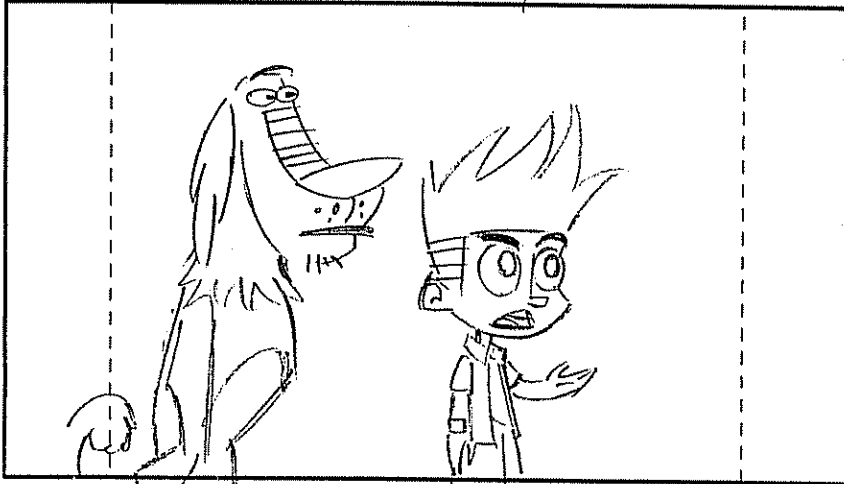

ACTION

SCENE

BG

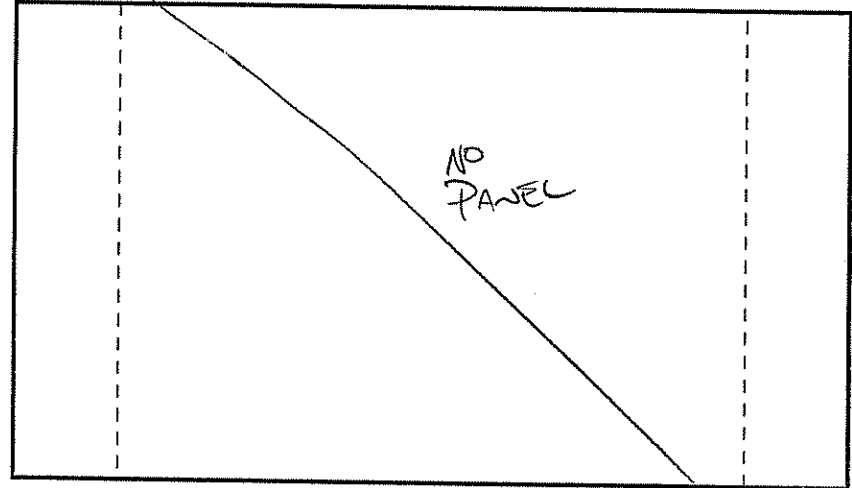

DIALOGUE

(33) Johnny = (cont'd)

how does that help me get Mint Chip?

NOTES



© 2006 Johnny Test Productions Inc "Johnny Test" TM Warner Bros. Entertainment Inc. All Rights Reserved

collidescope animation studios

202 B



EPISODE: _____ | PAGE: 068

SCENE (068)

1/2

BG

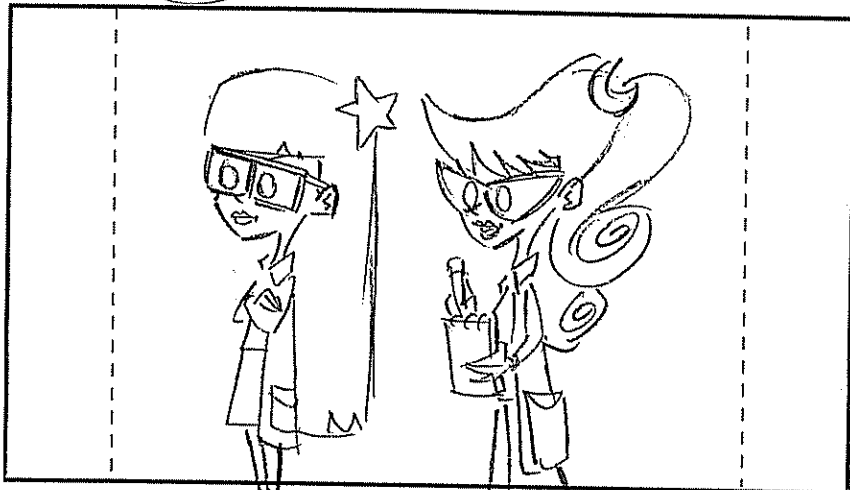

ACTION

(M)

SCENE

2/2

BG

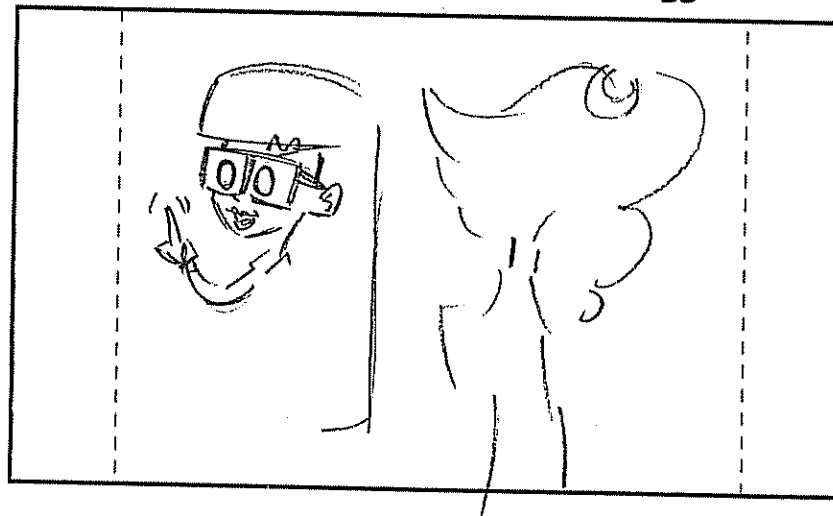

DIALOGUE

34. MARY
If you test it and like it...

35. SUSAN
We'll make you some super tasty and healthy mint chip ice cream.

NOTES



© 2006 Johnny Test Productions Inc "Johnny Test" TM Warner Bros Entertainment Inc All Rights Reserved.

collidescope animation studios

202 B

⊕ PAGE # 69A NEXT!

PAGE: 69



SC # (069)

BG

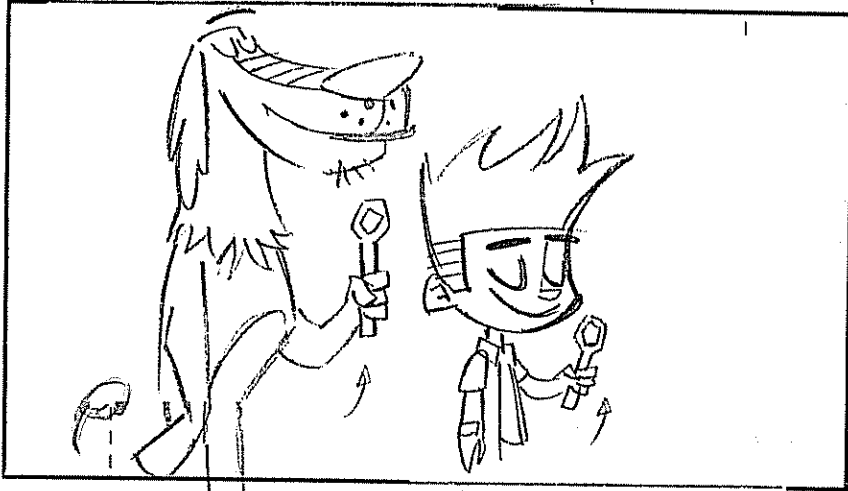

ACTION

(CUT) to Johnny & Diesel
Holding up spoons. (WIPE OUT)

DIALOGUE

NOTES



© 2006 Johnny Test Productions Inc "Johnny Test" TM Warner Bros Entertainment Inc. A

SCENE (69A)

PANEL

BG

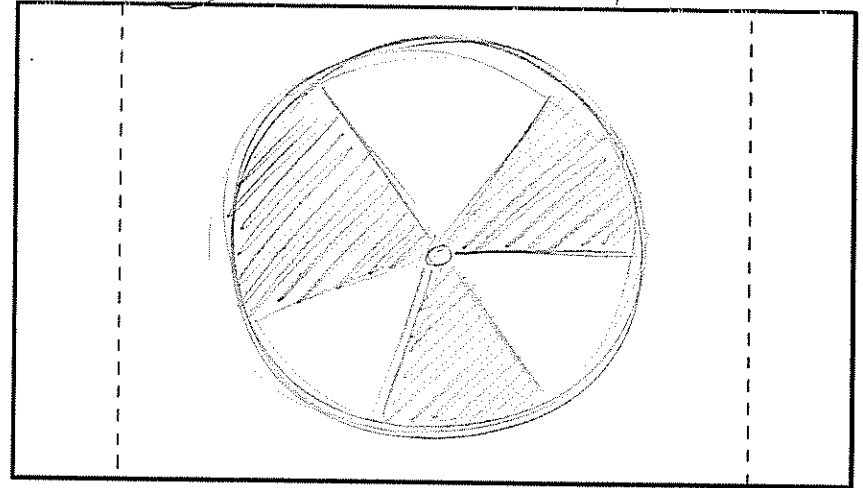

TEST WIPE

(AZ) - VIS -

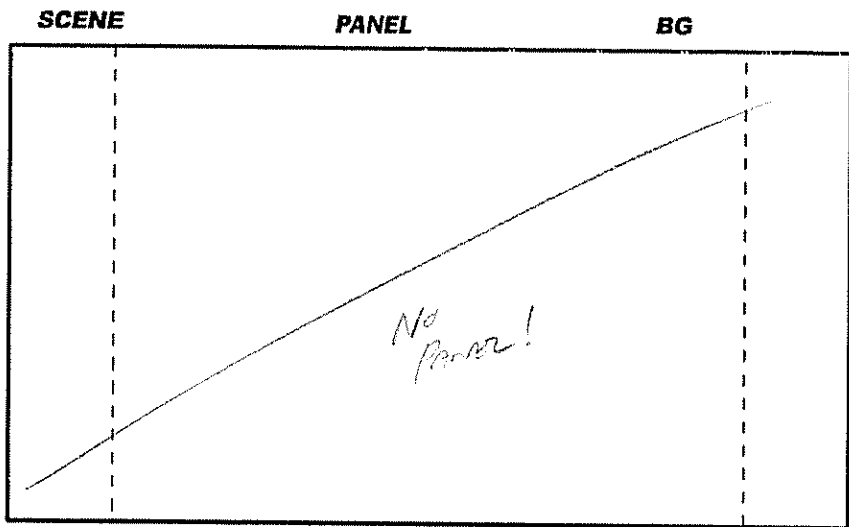

ACTION

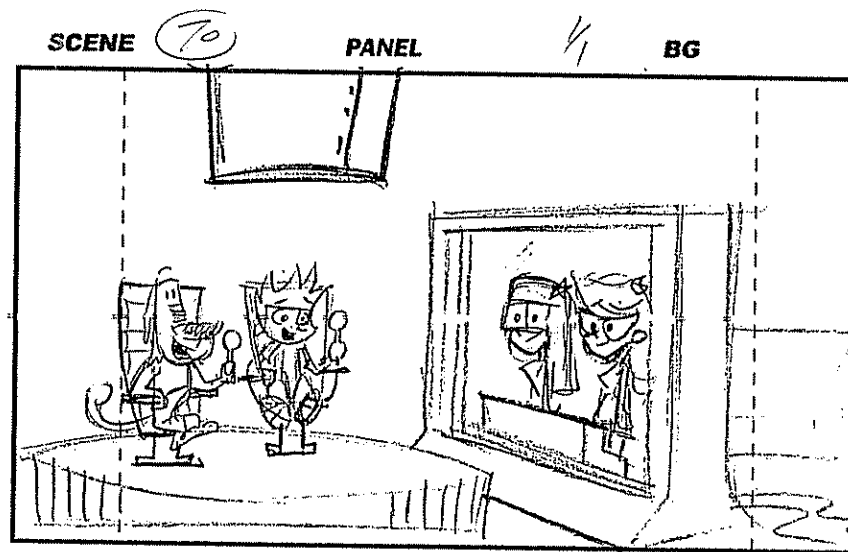

WIPE IN

TO LVB (EISENHOWER).
 - Johnny & Duref sitting in chairs
 - Mary & Susan latch behind shield

DIALOGUE

Johnny & Duref: (ADR)
 LET THE TEST ...

NOTES

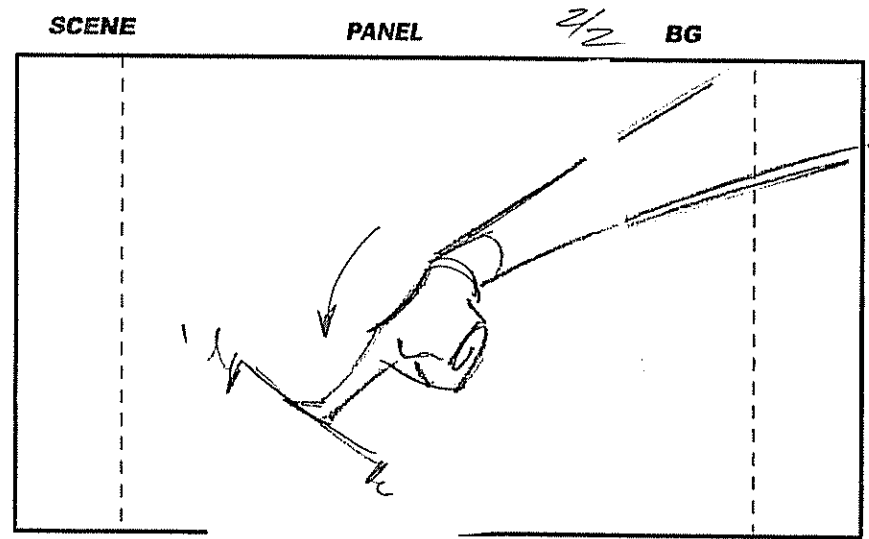
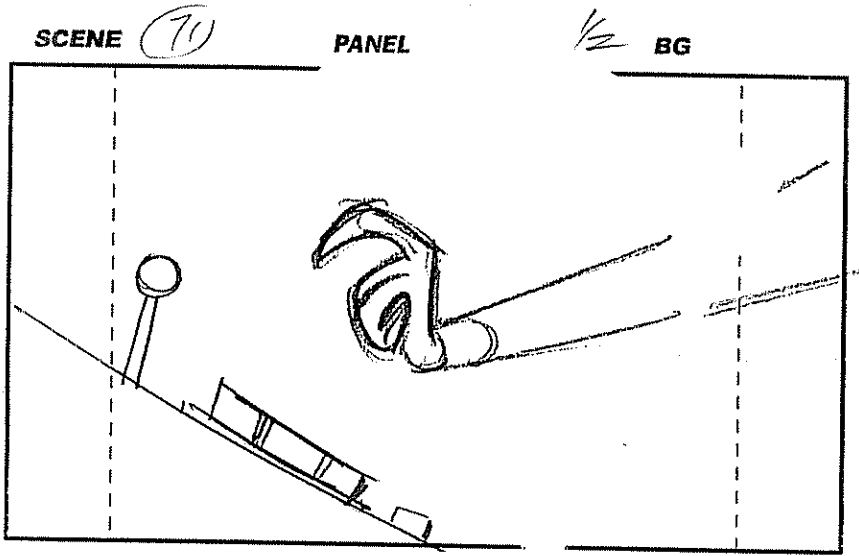

ACTION

(C)

CLOSE ON SEAN'S HAND
OVER BUTTON.

SUSAN PRESSES BUTTON!

DIALOGUE

JOHNNY/DUKEY: (CONT'D.S.)
(ADR)
...BEGIN!

NOTES

SCENE

72

PANEL

1/2

BG

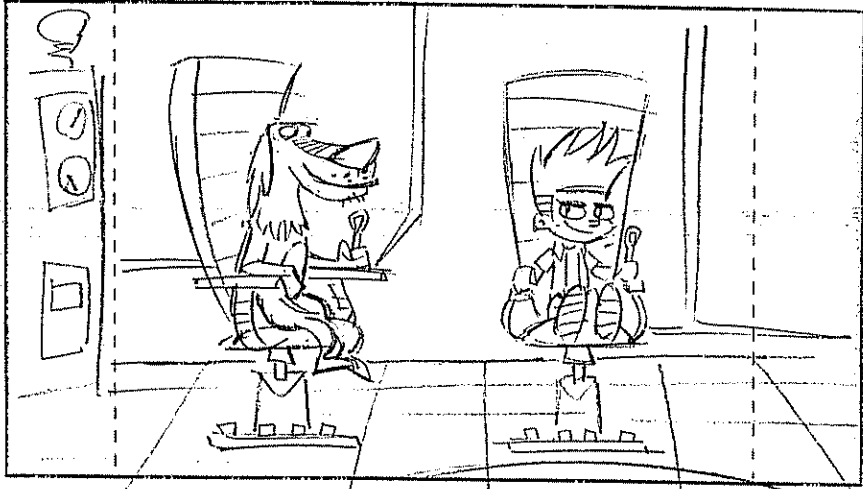

ACTION

To Johnny & Duke

CUT

SCENE

PANEL

2/2

BG

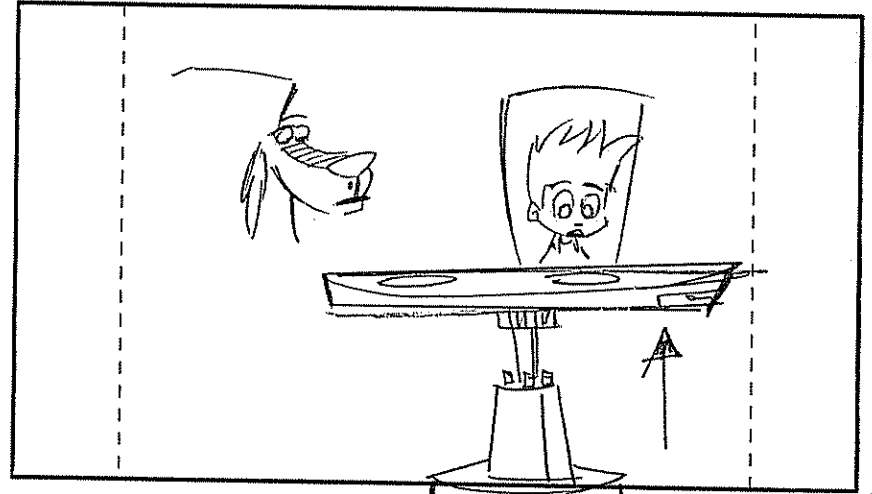

- TABLE RISES UP
- DUKE & JOHNNY REACT!

DIALOGUE

NOTES

SCENE

72A

PANEL

1/2

BG

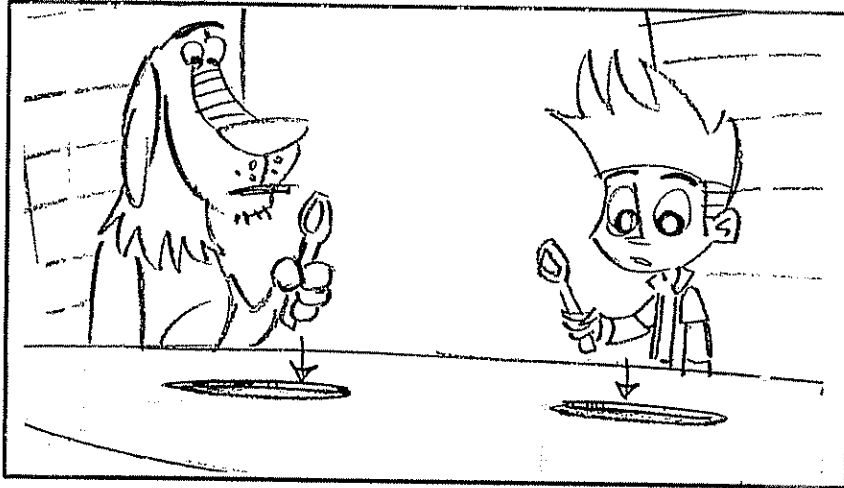

ACTION

CU

CLOSER ON JOHNNY & DROOP.
- OPENINGS APPEAR IN TABLE.

SCENE

PANEL

2/2

BG

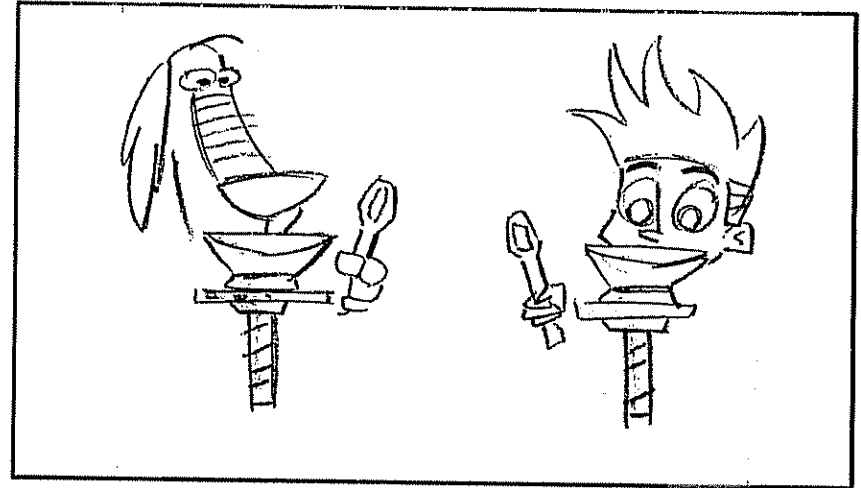

- BARS RISE UP.

DIALOGUE

NOTES

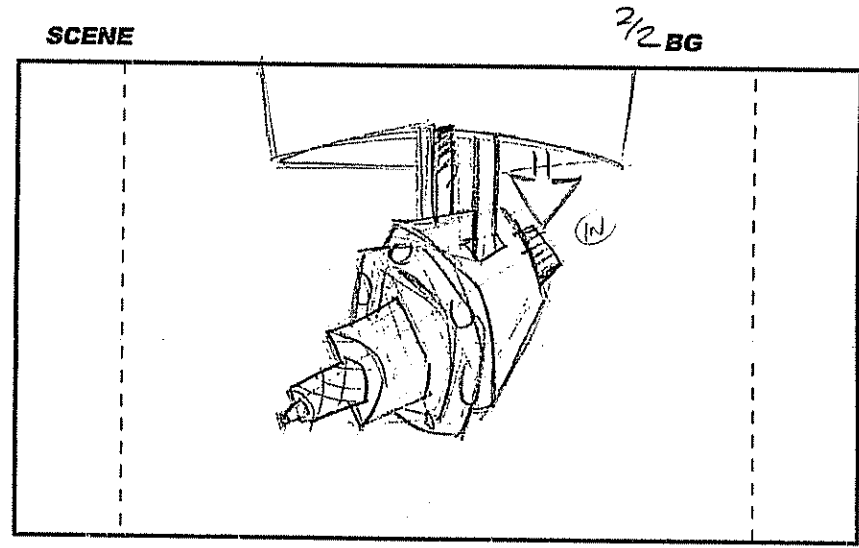
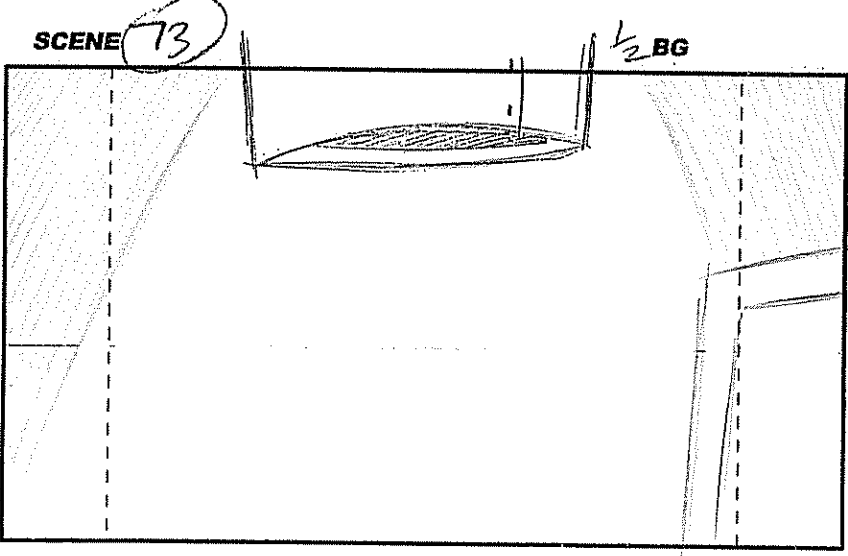

ACTION

AT

LASER BEGINS TO LOWER FROM CEILING PORT

DIALOGUE

SFX:
(Whirring!)

NOTES



2028



EPISODE: _____

PAGE: 073

SCENE (074)

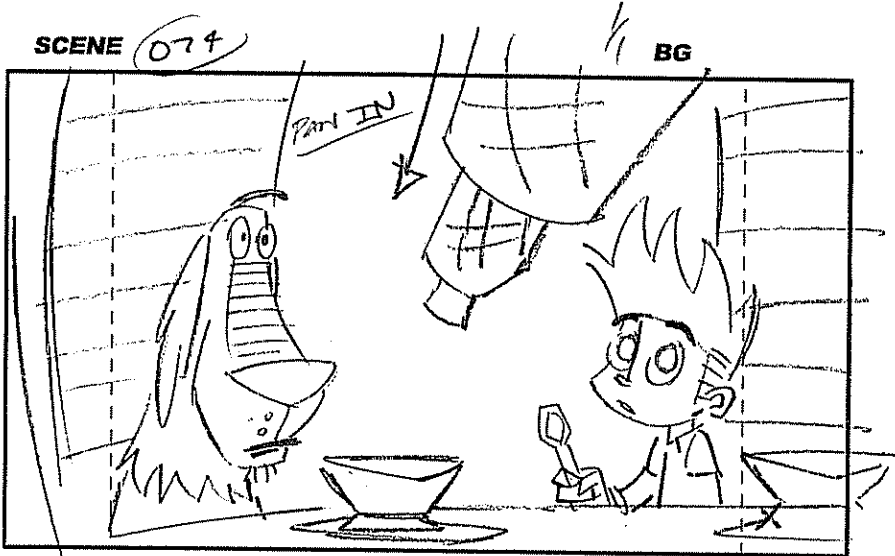

SCENE (075)

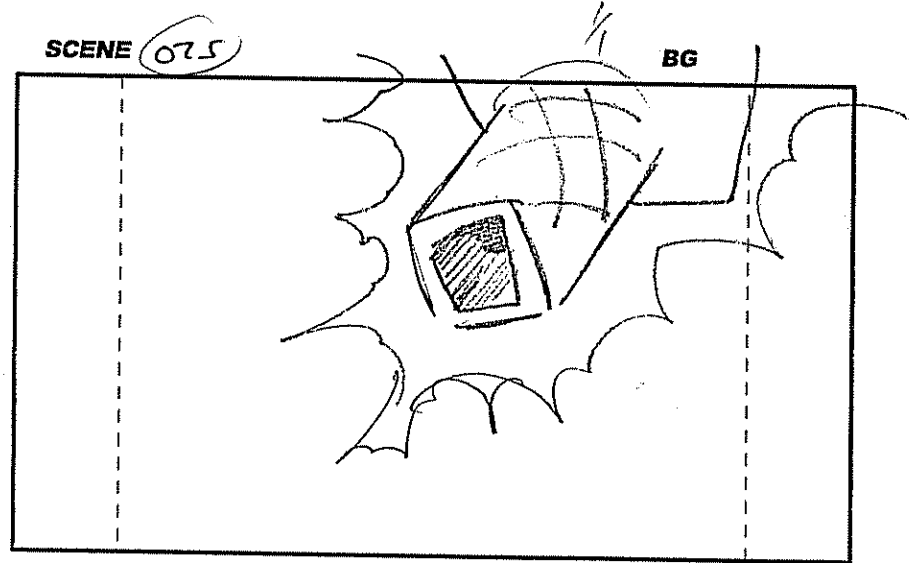

ACTION

- LASER IN FROM ABOVE & SEPS.
(W) - DROPT & JOHNNY'S EYES FOLLOW LASER.

(W)

CLOSE ON LASER

DIALOGUE

SFX:
(LAWR) ~~~~~ (CLICK!)

SFX:
(POWERS UP!)

NOTES



2023



EPISODE: _____

PAGE: 074

SCENE (076)

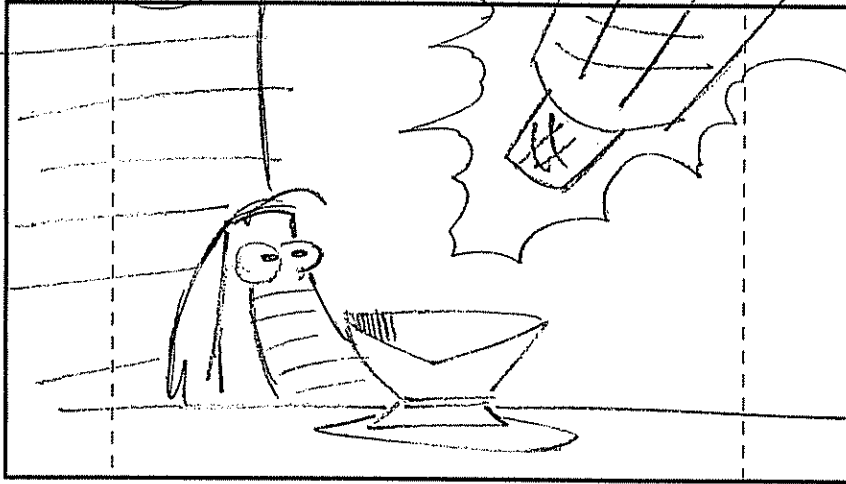

SCENE

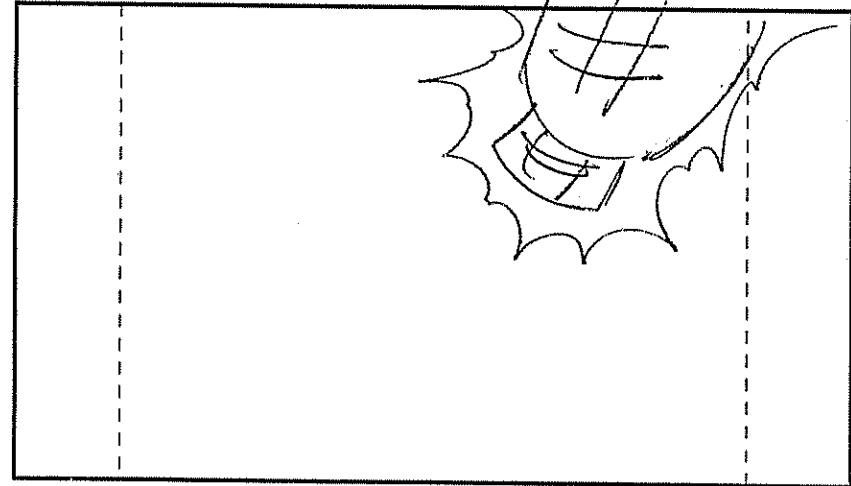

ACTION

cut

LASER ANTICS

DIALOGUE

*Sfx: (Cont'd)
(Powers up!)*

NOTES



© 2006 Johnny Test Productions Inc "Johnny Test" TM Warner Bros Entertainment Inc All Rights Reserved

collidescope animation studios

SCENE 76 cont'd

3/3

BG

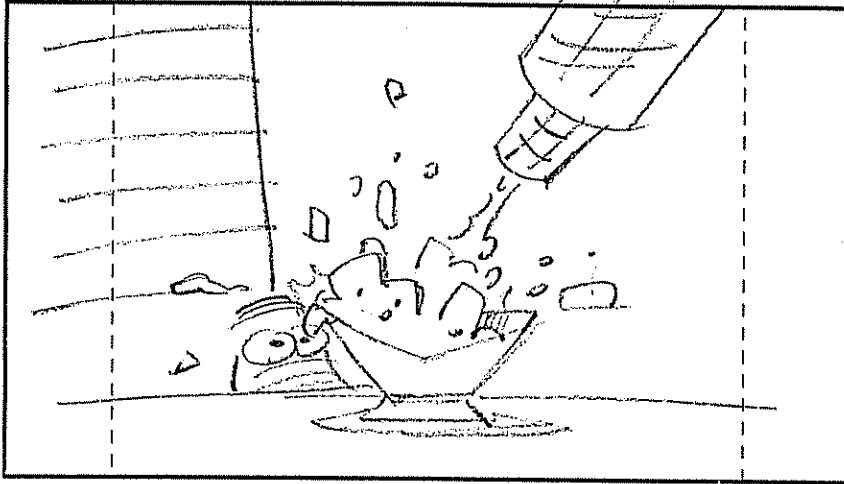

ACTION

- IT FIRES UPON THE
BOWL.. FILLING IT W/
ICE CREAM..

DIALOGUE

SFX:
(SPLASH!)

NOTES

SCENE 77

1/4

BG

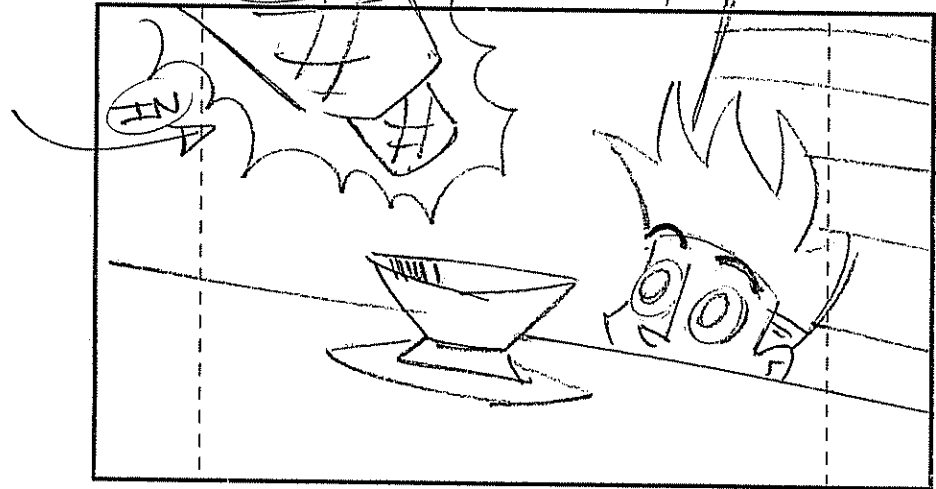

CUT

TO JOHNNY/HIDING BEHIND TABLE
- LASER COMES IN & STOP.

SFX:

(WHIRRING) → (CLICK!)

202 B



EPISODE: _____

PAGE: 076

77 cont'd

SCENE

2/d

BG

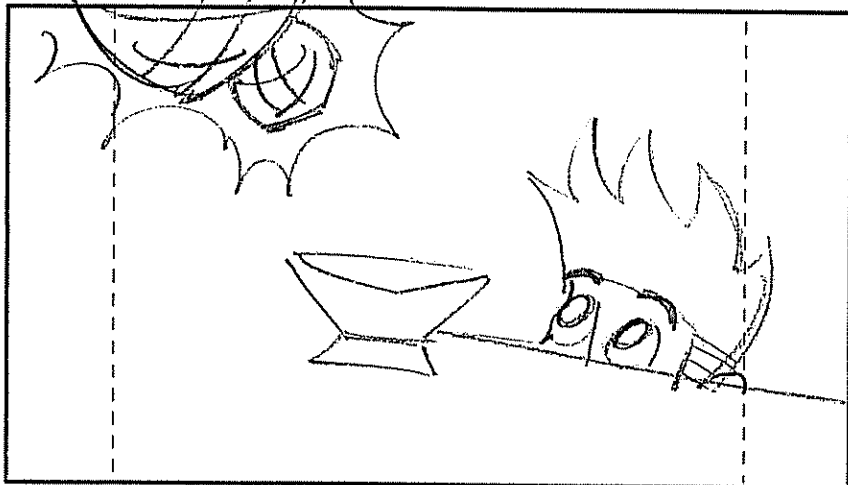

SCENE

3/4

BG



ACTION

LASER AIMS

LASER FIRES ICE CREAM INTO BOWL

DIALOGUE

SFX:
(SPLASH!)

NOTES



© 2006 Johnny Test Productions Inc "Johnny Test" TM Warner Bros Entertainment Inc. All Rights Reserved.

collidescope animation studios

202 B



(R2) - DIRL

SCENE

77 cont'd

4/4

BG

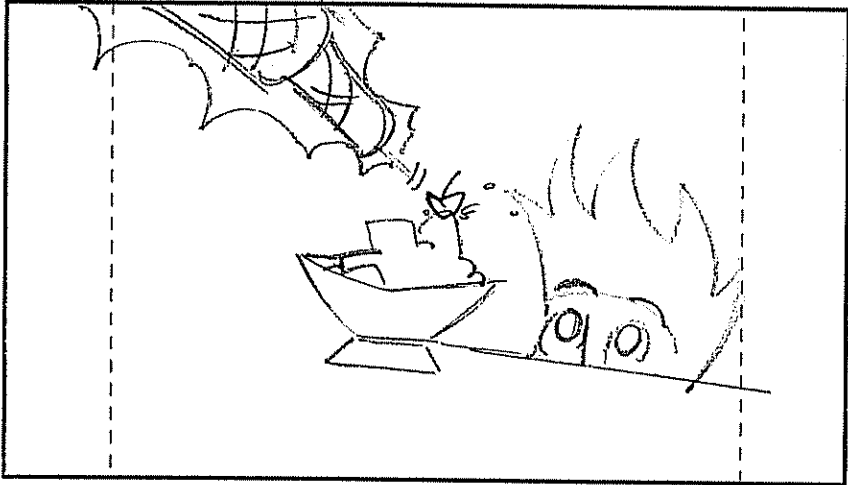

ACTION

LASER FIRES CHERRY ONTO
ICE CREAM.

SCENE

(078)

BG



(art) To Susan & Mary

DIALOGUE

SFX -
(THOOPP!)

Susan & Mary = (GIT)
IT WORKS!

NOTES



(R2)

202 B

R2 - PAGE # 078A NEXT!



R2 - PANELS.

EPISODE: _____ | PAGE: 078

SCENE (079)

1/5 BG

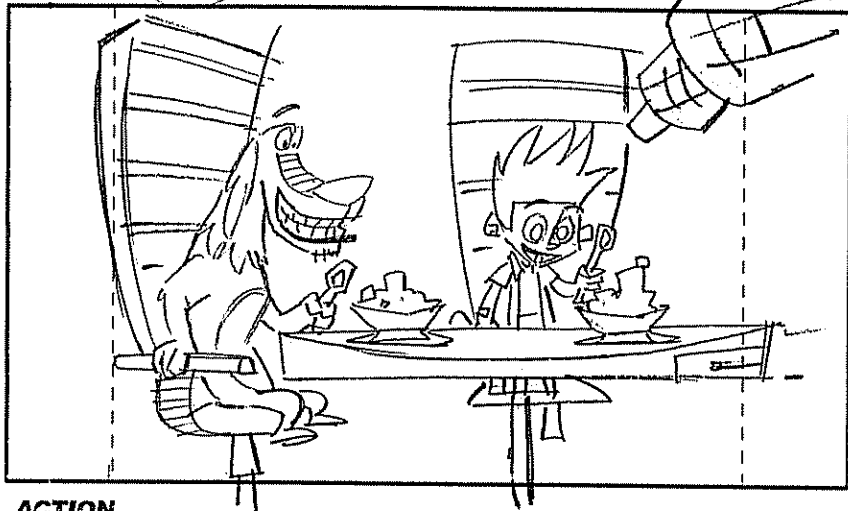

SCENE

2/5 BG

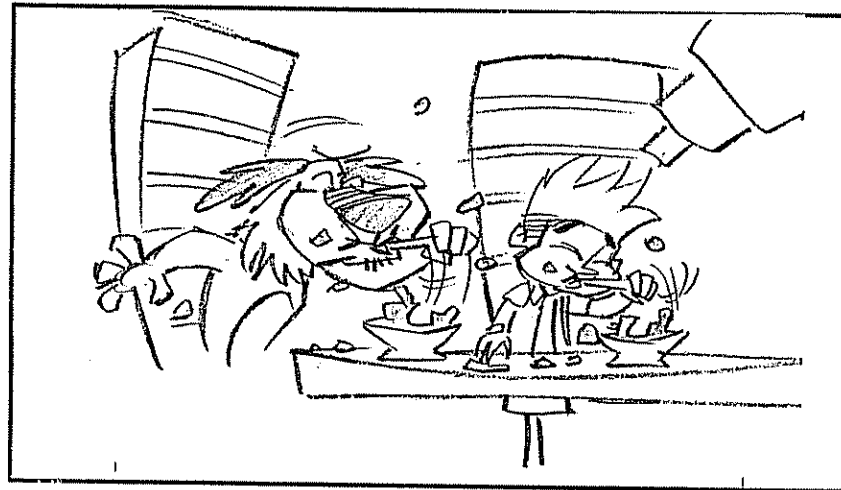

ACTION

(W)

- THEY TRY IT!

DIALOGUE

NOTES



© 2006 Johnny Test Productions Inc "Johnny Test" TM Warner Bros Entertainment Inc. All Rights Reserved

collideascope animation studios

R2



(R2) - NEW PAGE

VIS.
(R2) - NEW PANEL

PAGE: 078A

SCENE 079 CONT PANEL 3/5 BG

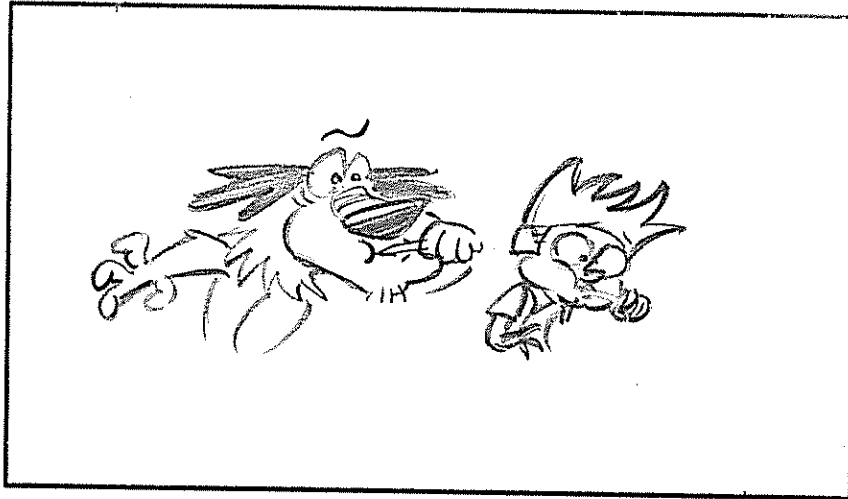

ACTION

THEY REACT

SCENE PANEL BG

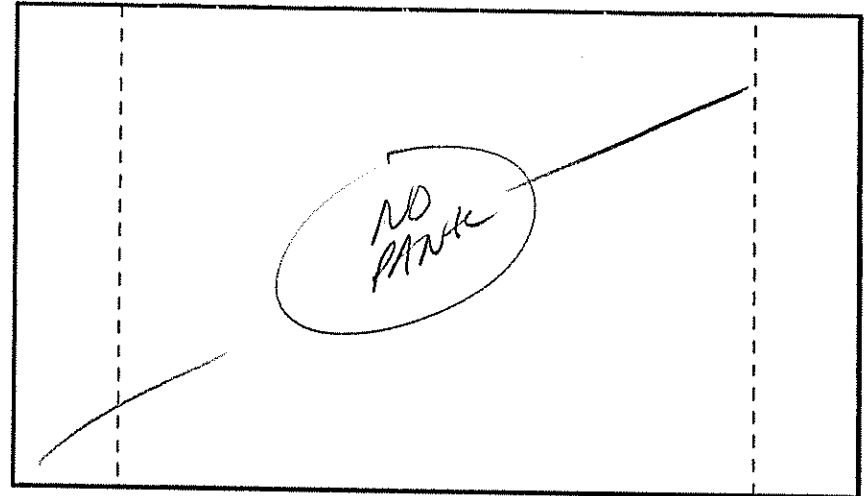

DIALOGUE

NOTES



© 2008 Johnny Test Productions Inc. "Johnny Test" TM Warner Bros. Entertainment Inc. All Rights Reserved.

collidescope animation studios

(R2)

202 B



SCENE 79 Cont'd

4/5 BG

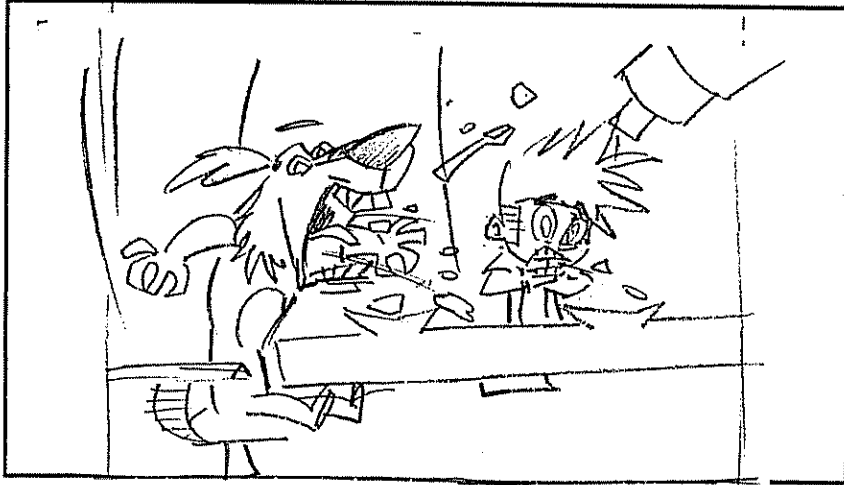

ACTION

BOTH REACT

SCENE

5/5 BG

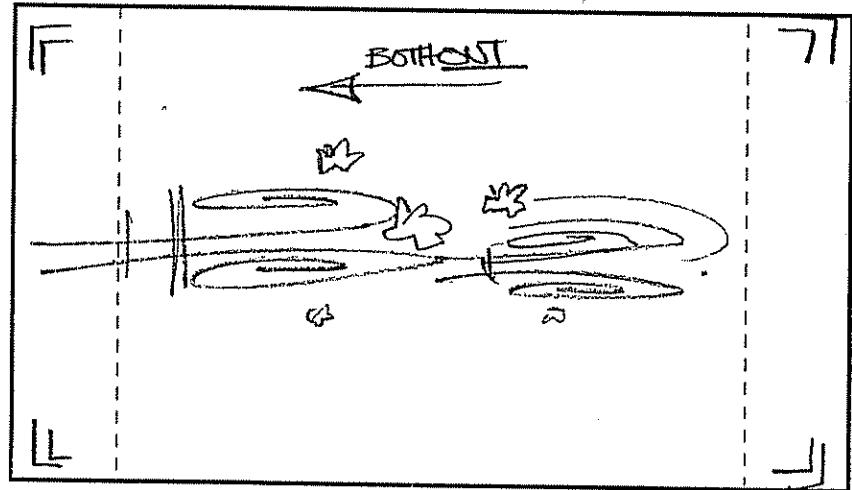

- BOTH ZIP OUT!
- CAMERA SHAKE

DIALOGUE

36. JOHNNY/DUKEY
AHHHHH!!!

SFX:
(CRASH!)

NOTES



202 B



EPISODE: _____

PAGE: 080

SCENE 080

BG

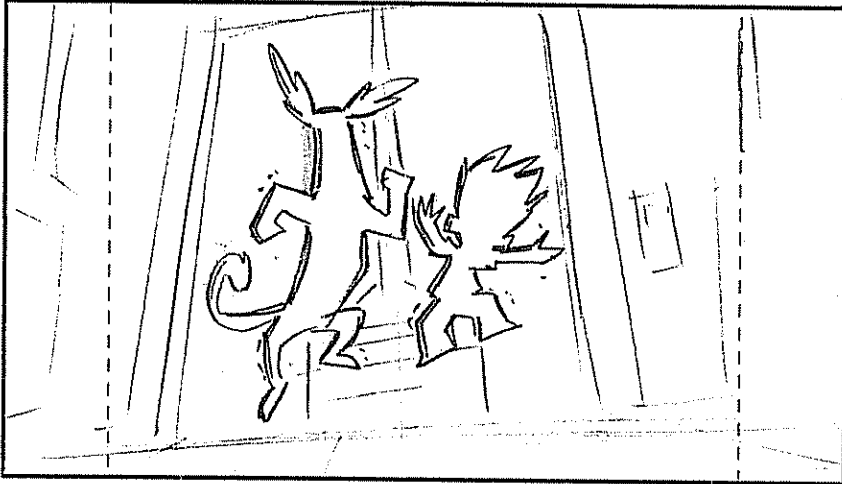

ACTION

(cut) To Dukey & Johnny Holes in Door

SCENE 081

BG

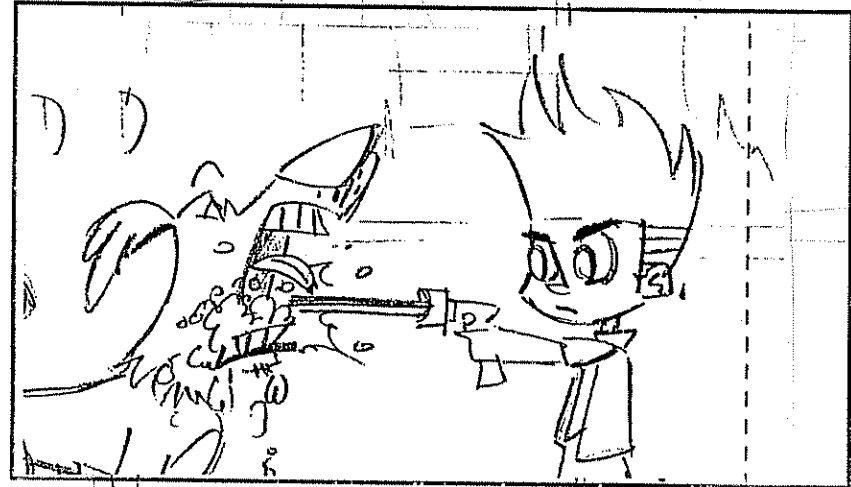

(cut) To Johnny spraying Dukey's mouth out.

DIALOGUE

37. DUKEY
Soap, I need more soap.

NOTES



© 2006 Johnny Test Productions Inc. "Johnny Test" TM Warner Bros Entertainment Inc All Rights Reserved.

 collidea scope animation studios

202 B



(R2) - VIS. - ACTION

EPISODE: _____ PAGE: 081

SCENE 082

1/4 BG

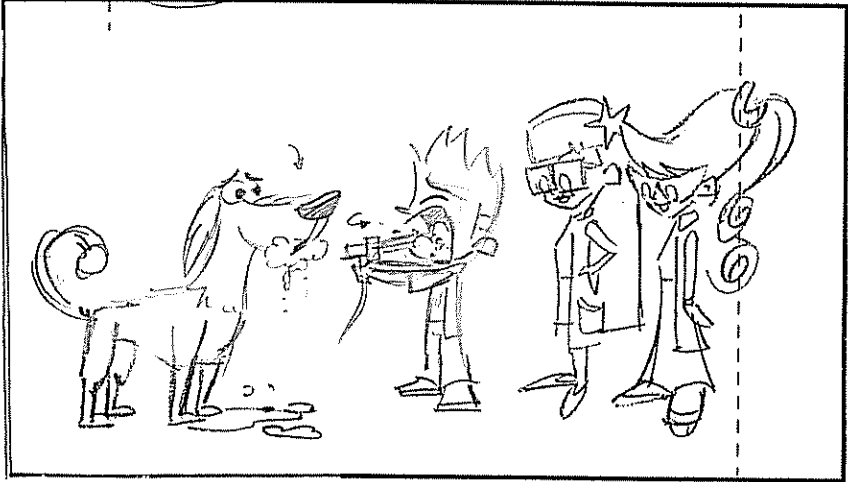

ACTION

(WR) WIDE on GROUP
- JOHNNY TURNS GUN TO HIS MOUTH.

DIALOGUE

38. MARY
So, what do think?

NOTES



© 2006 Johnny Test Productions Inc "Johnny Test" TM Warner Bros Entertainment Inc. All Rights Reserved

(R2) - DIR. - US -

SCENE 083

1/2 BG

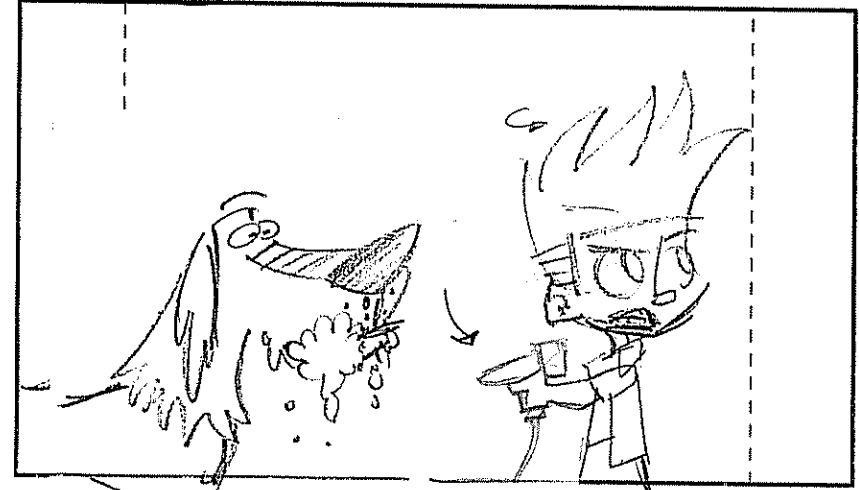

(WR) TO DUCK & JOHNNY.

39. JOHNNY
Unl. ... I think you used too

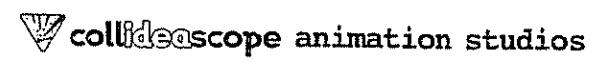

202 B



P2 - 0112

EPISODE: _____

PAGE: 082

SCENE 83

CONT'D

2/2

BG



ACTION

PARV WITH ACTION (RT)

JOHNNY TOSSES HOSE OUT

CUT

SCENE 084

BG



DIALOGUE

Johnny - (Cont'd)

... much barf.

40. SUSAN
To get an "A" we need this iced
barf to taste good!

NOTES



© 2006 Johnny Test Productions Inc "Johnny Test" TM Warner Bros Entertainment Inc All Rights Reserved

collidescope animation studios

202 B



SCENE 085

1/2 BG



SCENE

(12) - D.M.L. -

1/2 BG

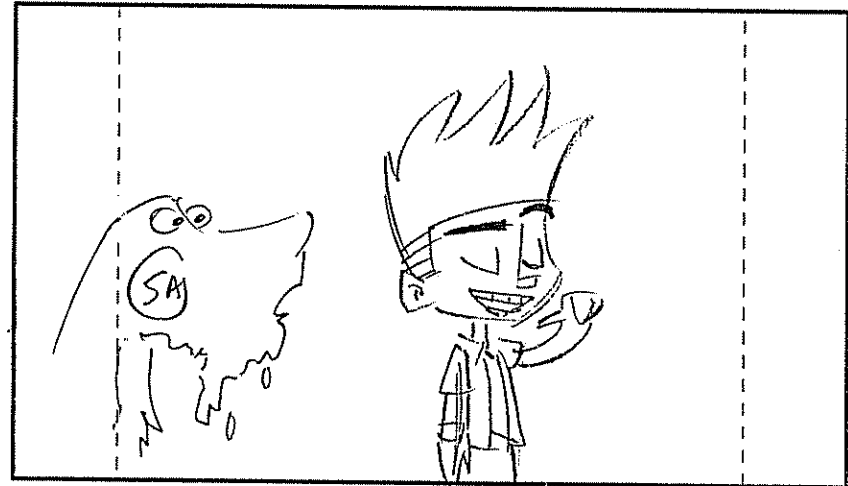

ACTION

(12)

DIALOGUE

41. JOHNNY
We need Mint Chip ice cream and

I have a plan. JOHNNY ((CONT))

NOTES



202 B

⊕ PAGE # 84A NEXT!



EPISODE: _____ | PAGE: 084

SCENE 086

1/4 BG



ACTION

cut To Susan & Mary

SCENE 087

1/2 BG

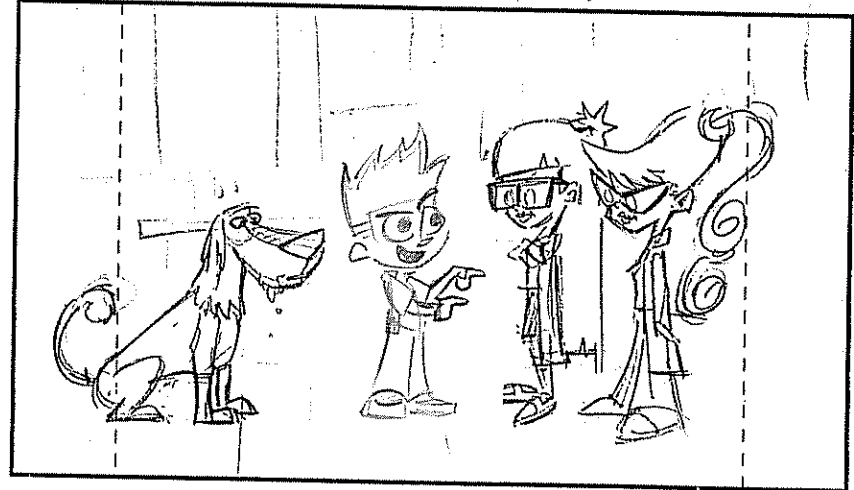

cut To group

DIALOGUE

42. SUSAN
Let's hear it, we could go for a good laugh.

43. JOHNNY

SUSAN AND MARY, THAT'S YOU, WILL DISGUISE THEMSELVES AS MOM...

NOTES



© 2006 Johnny Test Productions Inc "Johnny Test" TM Warner Bros Entertainment Inc All Rights Reserved.

collidescope animation studios

SCENE 87 cont'd PANEL 2/2 BG

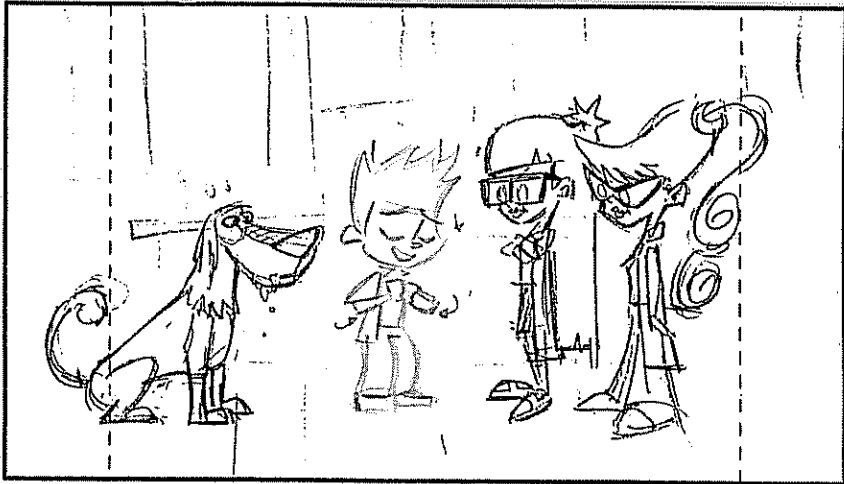

ACTION

SCENE 87A PANEL 1/2 BG



CUT

CLOSE ON JOHNNY GESTURES TO HIS DEXTER.

DIALOGUE (4E) Johnny: (cont'd)
... AND TAKE JOHNNY, THAT'S ME...

(4E) Johnny: (cont'd)
... AND HIS FRIEND WITH A RARE HAIR DISORDER...

NOTES

SCENE 87A CONT'D PANEL 2/2 BG



ACTION Johnny's HAND OUT.

SCENE PANEL BG

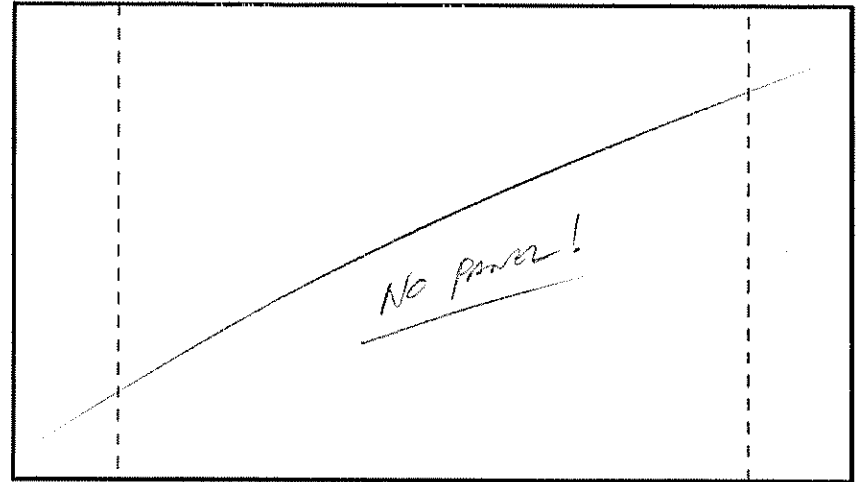

DIALOGUE (43) Johnny: (CONT'D)
... ON THE ICE/ICE CREAM FACTORY
TOUR...

NOTES

202 B



EPISODE: _____ | PAGE: 085

SCENE

81B

1/4

BG

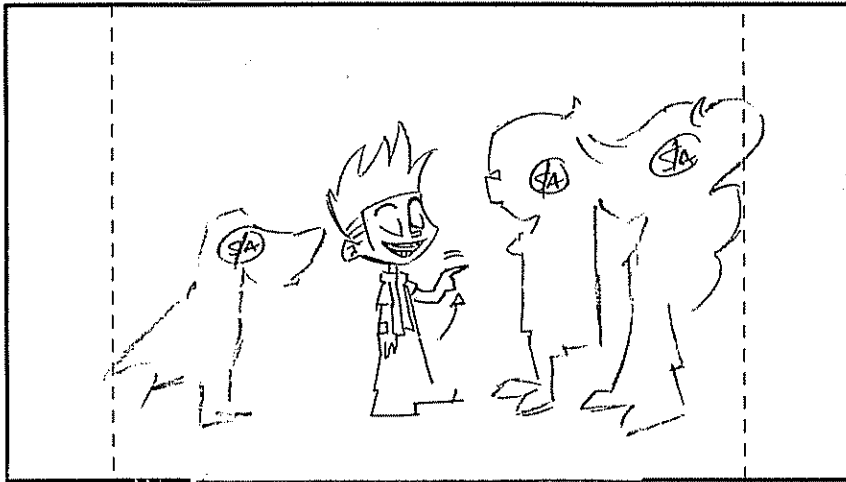

SCENE

2/4

BG

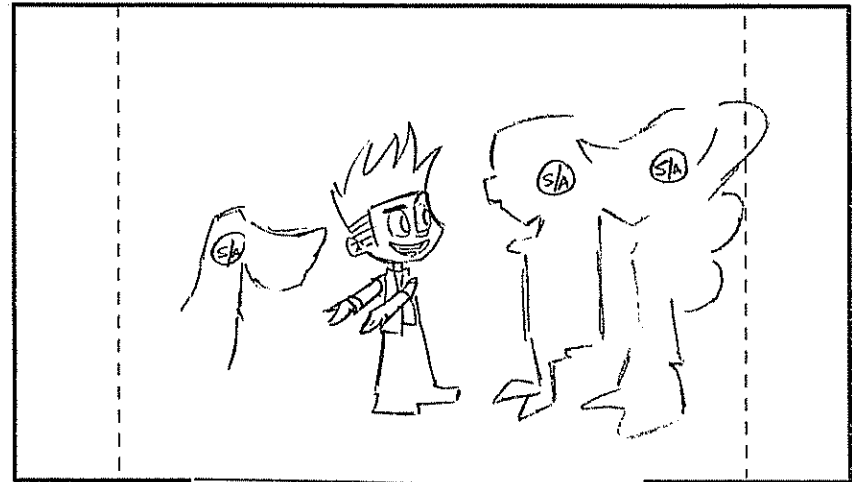

ACTION

WIDE ON GROUP

(CUT)

DIALOGUE

(43) Johnny: (conSID)

... where you two
can break into the lab, steal the
TASH SECRETS ...

... and Dukey AND I...

NOTES



© 2006 Johnny Test Productions Inc "Johnny Test" TM Warner Bros Entertainment Inc All Rights Reserved

collideoscope animation studios

2023



EPISODE: _____ PAGE: 086

SCENE 87B CONT'D

3/4

BG

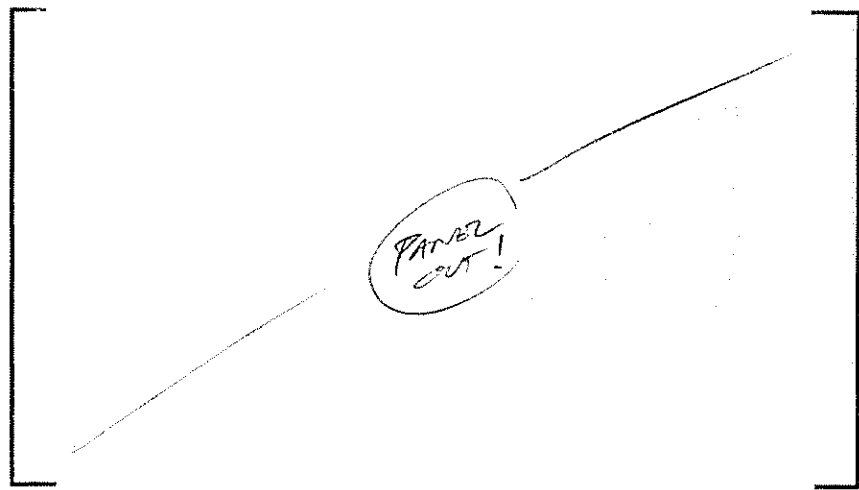

AC

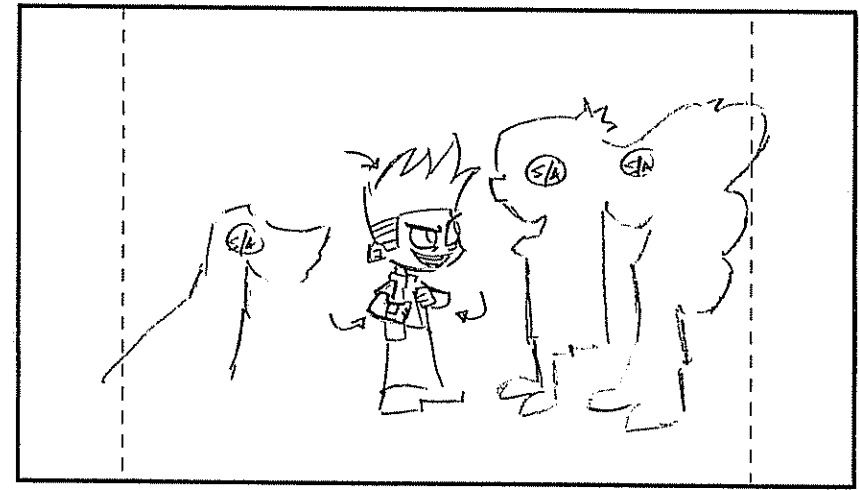

DIALOGUE

(AS) Johnny: (CONT'D)
... CAN get tons of...

NOTES



© 2006 Johnny Test Productions Inc "Johnny Test" TM Warner Bros Entertainment Inc All Rights Reserved

collidescope animation studios

202 B



EPISODE: _____ | PAGE: 087

SI



SCENE 87B (Cont'd)

4/4

BG

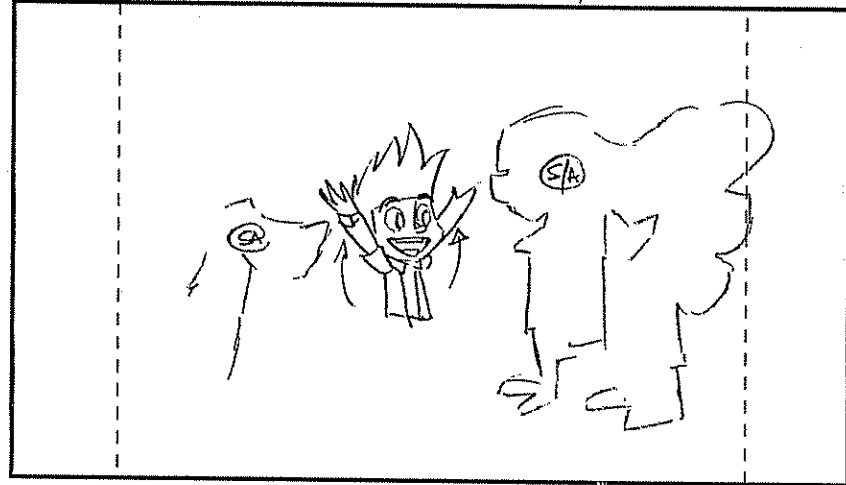

AC

DIALOGUE

(4/3) Johnny: (Cont'd)
... FREE mint chip samples!

NOTES



© 2006 Johnny Test Productions Inc "Johnny Test" TM Warner Bros Entertainment Inc. All Rights Reserved

collidescope animation studios

202B

⊕ PAGE # 88A NEXT!



Re - Panel #'s

EPISODE: _____ | PAGE: 088

Re - Action

SCENE 088

BG

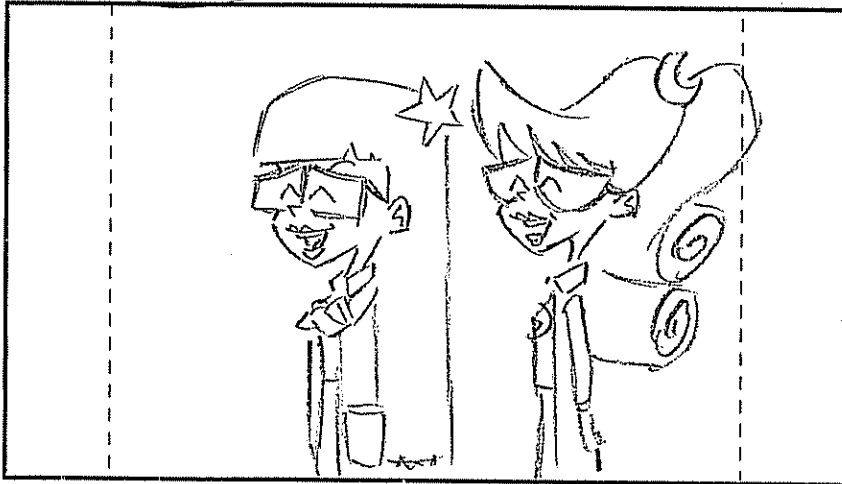

SCENE

BG



ACTION

Re To SUSAN & MARY LAUGHING.

WIPE OUT

DIALOGUE

44. SUSAN/MARY
Ha ha ha...

SUSAN / MARY: (CONT)
Wait, that's not bad.

NOTES



© 2006 Johnny Test Productions Inc. "Johnny Test" TM Warner Bros Entertainment Inc. All Rights Reserved

collidescope animation studios



RE - NEW SC!

2026

(RE) - NEW PAGE!
PAGE # 88B NEXT! PAGE: 88A

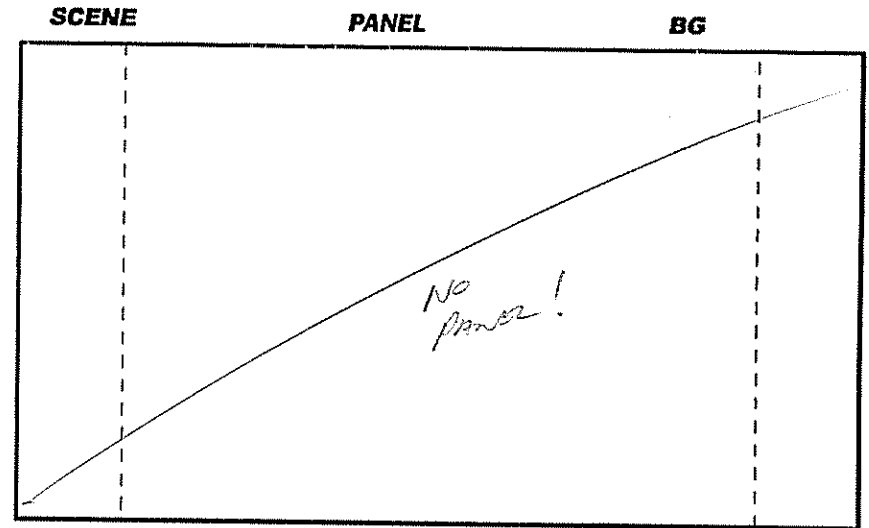
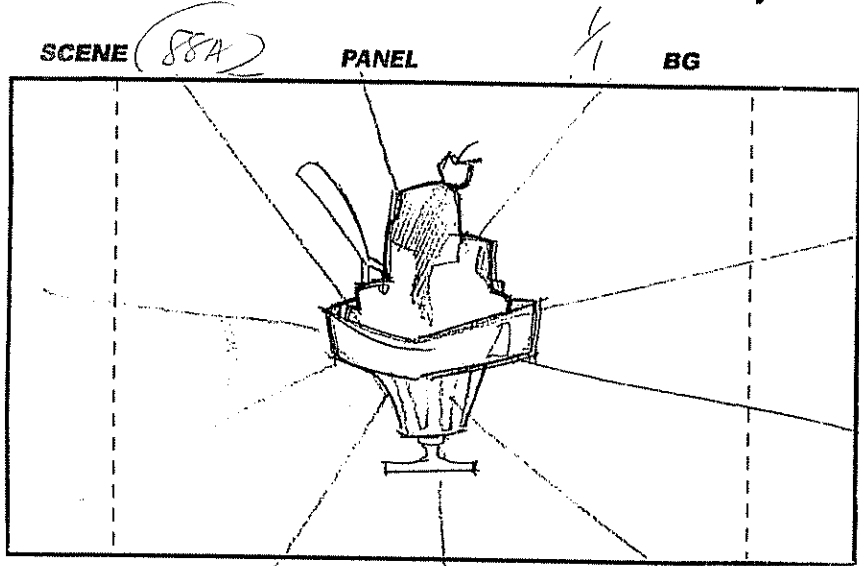

ACTION

ICE CREAM WIFE

DIALOGUE

NOTES



202 B

R2 - PG #



R2 - RCT/and

EPISODE: _____

PAGE: _____

88

SCENE (089)

BG

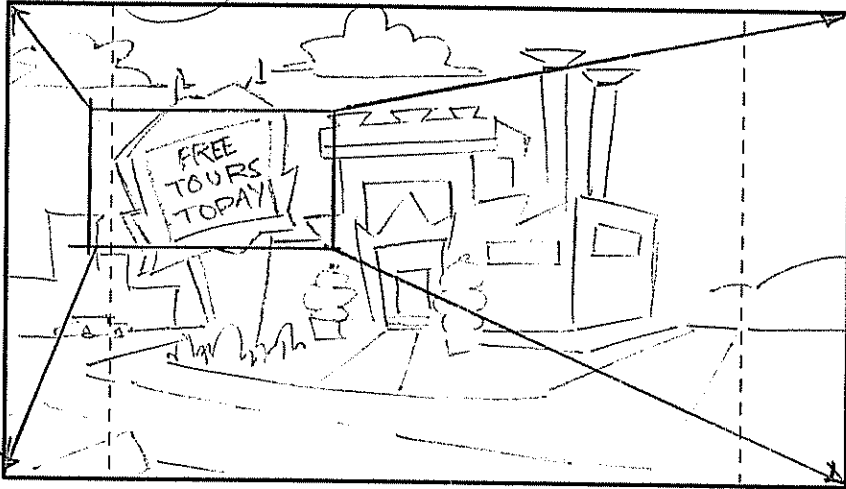

See 90 at!

ACTION

Wire IN

ZOOM OUT

SIGN - EXT. ICE CREAM FACTORY..

DIALOGUE

NOTES



© 2006 Johnny Test Productions Inc. "Johnny Test" TM Warner Bros Entertainment Inc. All Rights Reserved

collideoscope animation studios

SCENE (87A)

PANEL

BG

SCENE

PANEL

BG

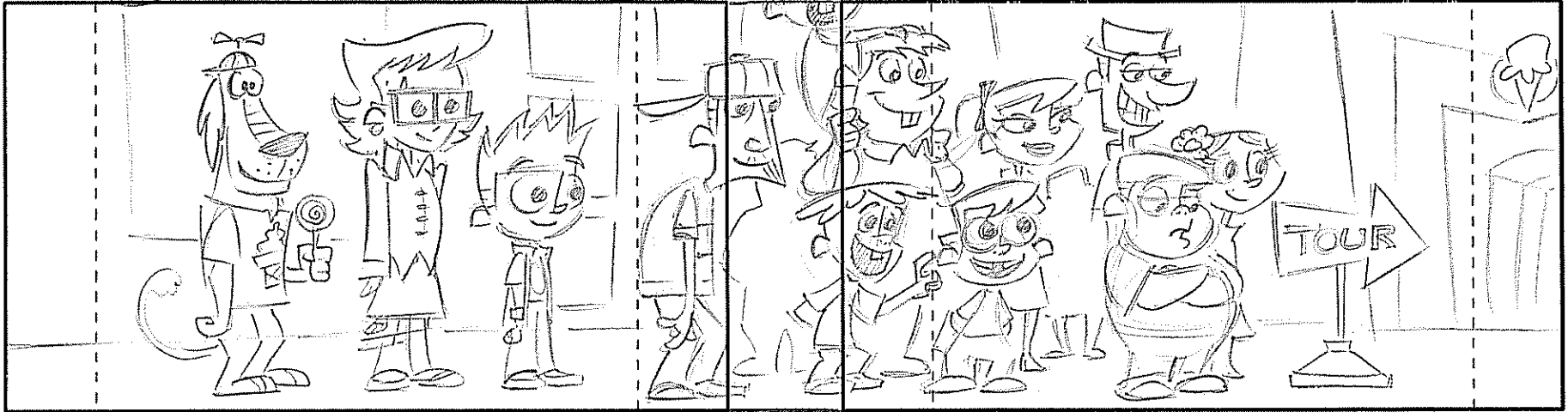

ACTION

(Stop) ← pan ← (Start)

(Cut) - TO VISITORS WAITING IN TOUR LINE.
- PAN IT ACROSS VISITORS TO JOHNNY, SUGAN & MARY, DANCEY.

DIALOGUE

NOTES

202B

PAN
w/ ACTION

(A)

(B)

SC#091

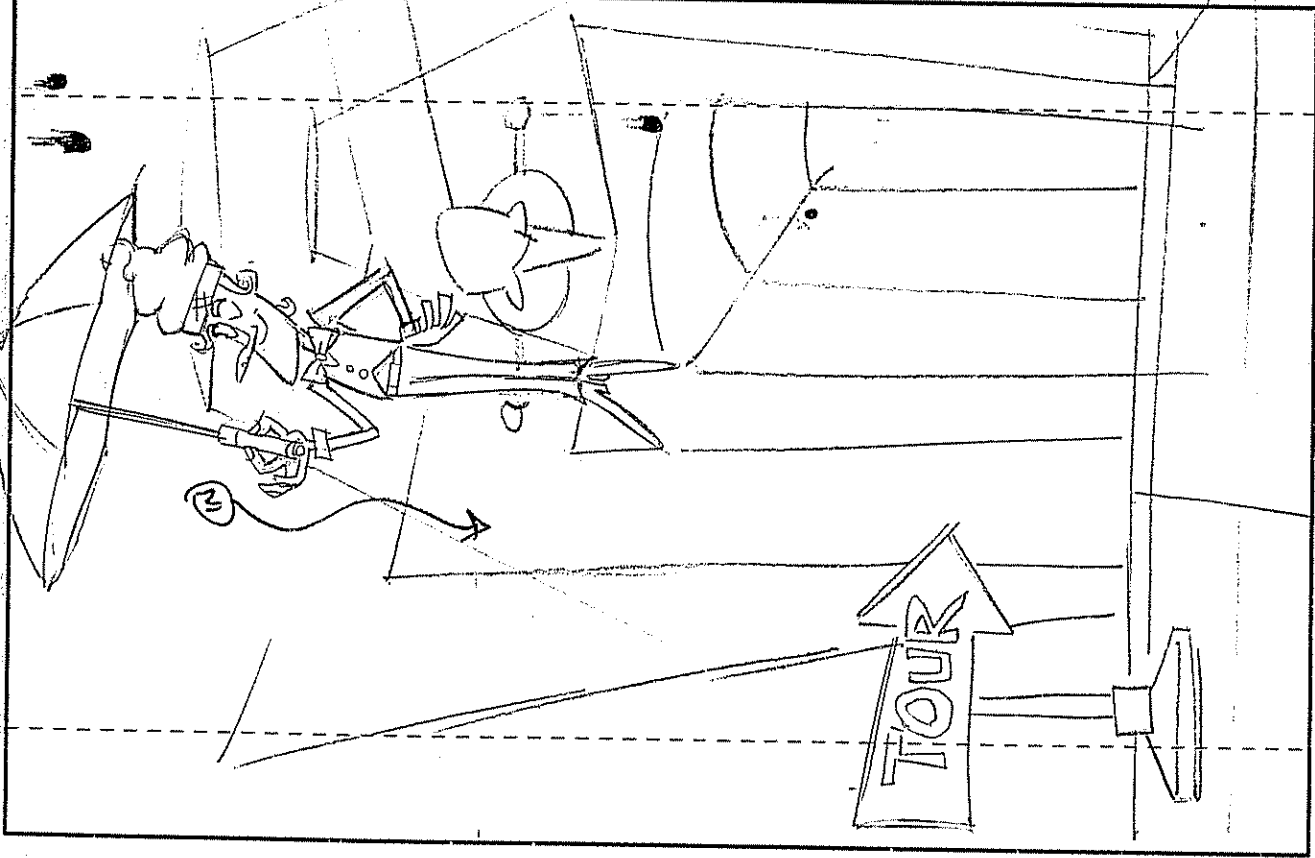

SC# 91

*NO
SC 90

— THE TOUR GUIDE FEARS (W/ FRAME VIA
UMBRELLA..

(C)

DIALO



© - US.

202.5

EPISODE: _____

PAGE: 091

SCENE (092)

BG

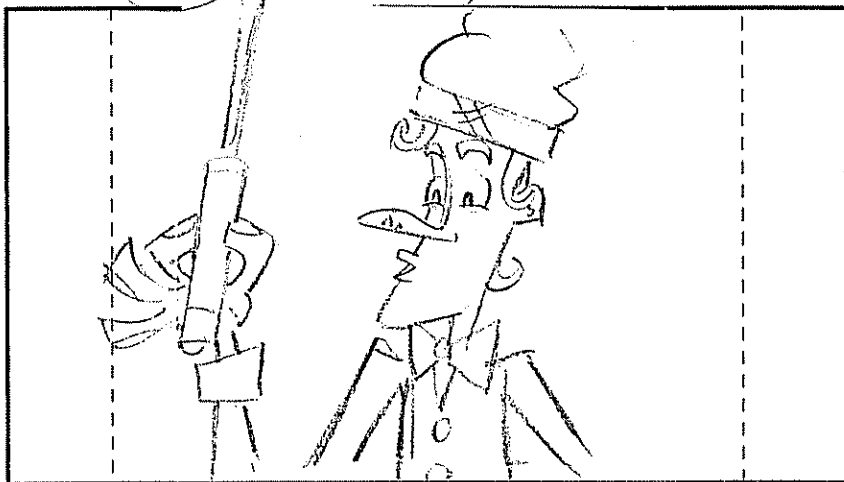

SCENE

BG



ACTION

CUT CLOSE ON TOUR GUIDE.

DIALOGUE

(45) TOUR GUIDE :

NOW LET'S BEGIN OUR TOUR OF OUR ...

TOUR GUIDE : (CONT)

... AMAZING FACTORY ...

NOTES



© 2006 Johnny Test Productions Inc "Johnny Test" TM Warner Bros. Entertainment Inc. All Rights Reserved

collideoscope animation studios

SCENE

92

PANEL

1/4

BG

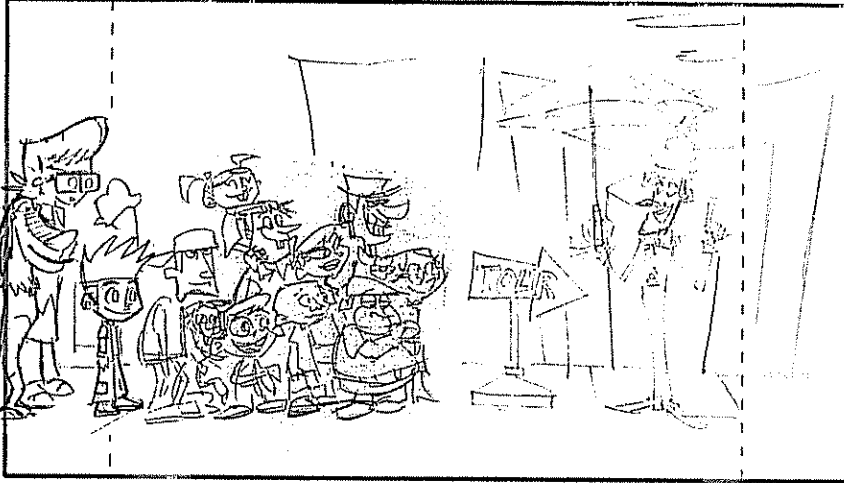

ACTION

WIDE TO GROUP & GUIDE

CUT

SCENE

PANEL

2/4

BG

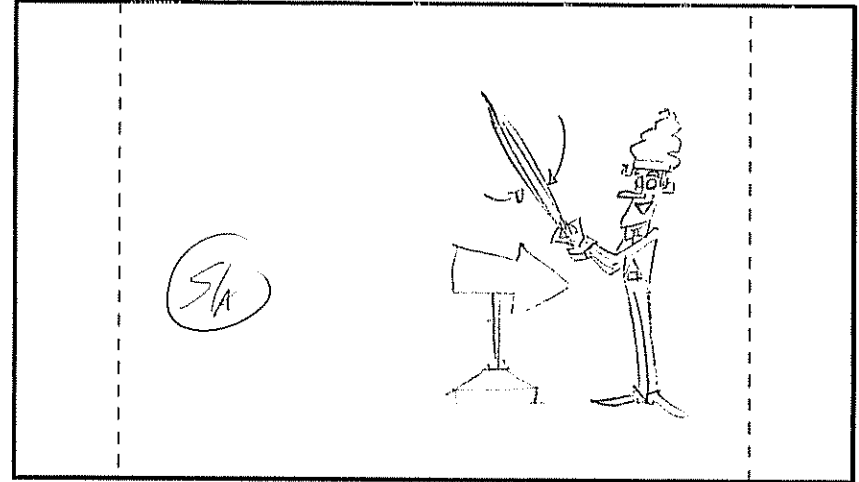

- GUIDE CLOSES HIS UMBRELLA.

DIALOGUE

(HS) TOUR GUIDE: (CONT'D)

... OR AS I LIKE TO CALL IT ...

... THE ICE CREAM WONDERLAND!

NOTES

SCENE 93 CONT'D PANEL 3/4 BG

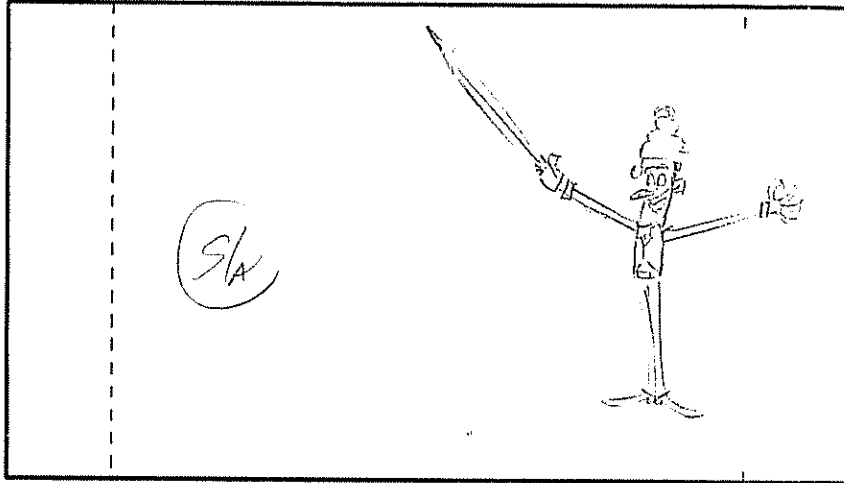

ACTION

SCENE PANEL 4/4 BG

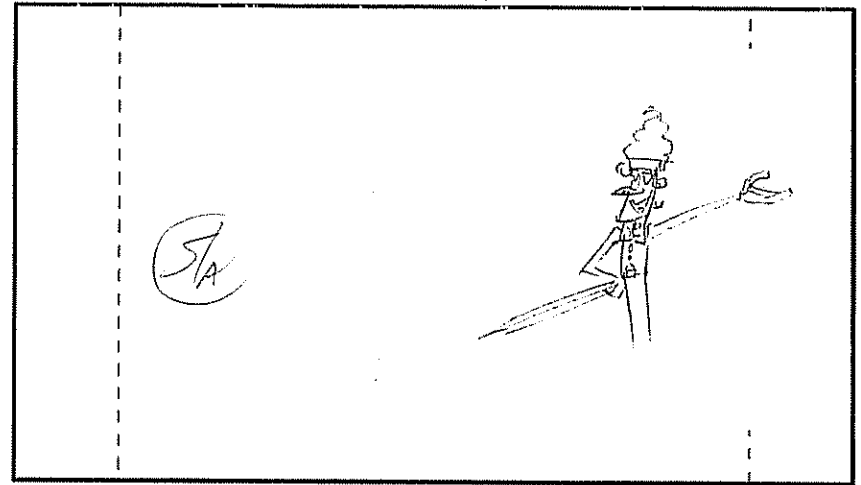

DIALOGUE (45) TOUR GUIDE : (CONT'D) TOUR GUIDE : (CONT)
OHAY THEN, WHAT YOU'RE ALL STANDING ON NOW... → IS CALLED, THE FLOOR!

NOTES

202B

(R2 -Pg. 94) art!



EPISODE: _____ | PAGE: 095

(R2) -DIA-

SCENE (094)

|| BG

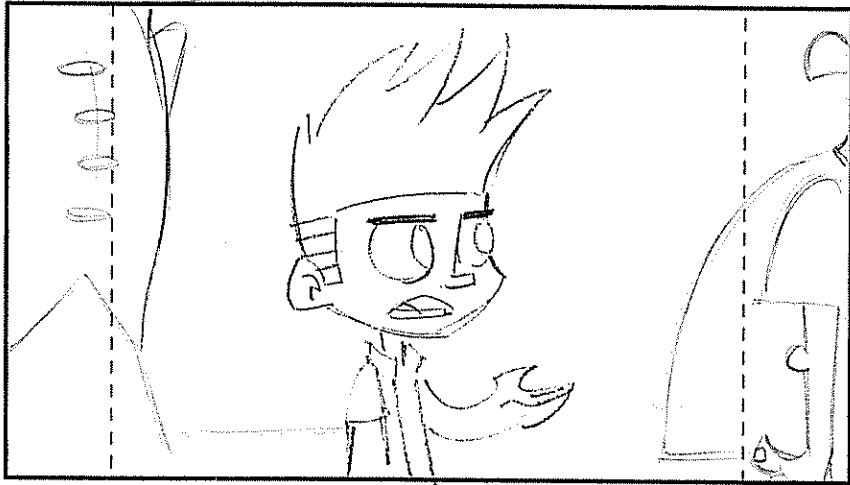

SCENE (095)

|| BG



ACTION

(art)

(art)

DIALOGUE

46. JOHNNY
When do we get the free samples?

47. TOUR GUIDE
At the end of the tour WHICH ...

NOTES



© 2006 Johnny Test Productions Inc "Johnny Test" TM Warner Bros Entertainment Inc. All Rights Reserved

collidea scope animation studios

(R2)



202 B

(R2) - SC# 096 OUT

EPISODE: _____ PAGE: 096

(R2) - D.M.C.

SCENE

BG

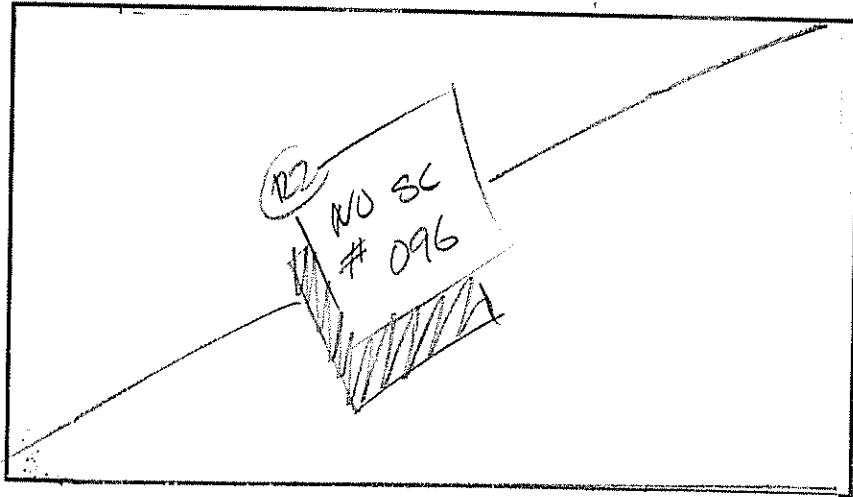

ACTI

SCENE (097)

BG



(cut)

- JOHNNY SMEERS

DIALOGUE

(47) Test Guide: (Cast 0/5)
... ONLY LASTS ...

NOTES



© 2006 Johnny Test Productions Inc "Johnny Test" TM Warner Bros. Entertainment Inc. All Rights Reserved

collideoscope animation studios

(R2)

202B



EPISODE: _____

PAGE: 097

SCENE (098)

BG



ACTION

cut

SCENE (099)

BG



cut

TO SUSAN CLEARING THREAT.

DIALOGUE

(47) TOUR GUIDE: (CONFID)
three hours.

48. SUSAN
Ehem.

NOTES



© 2006 Johnny Test Productions Inc "Johnny Test" TM Warner Bros Entertainment Inc. All Rights Reserved.

collideoscope animation studios



2028

SCENE 99) cont'd 2/3 BG



ACTION

SCENE 3/3 BG



DIALOGUE

(48) SUSAN: (cont'd)
where's the lab where you
create the recipes for your

SUSAN: (CONT)
delicious and not barfy ice cream?

NOTES



202B



SCENE 100

1/2 BG

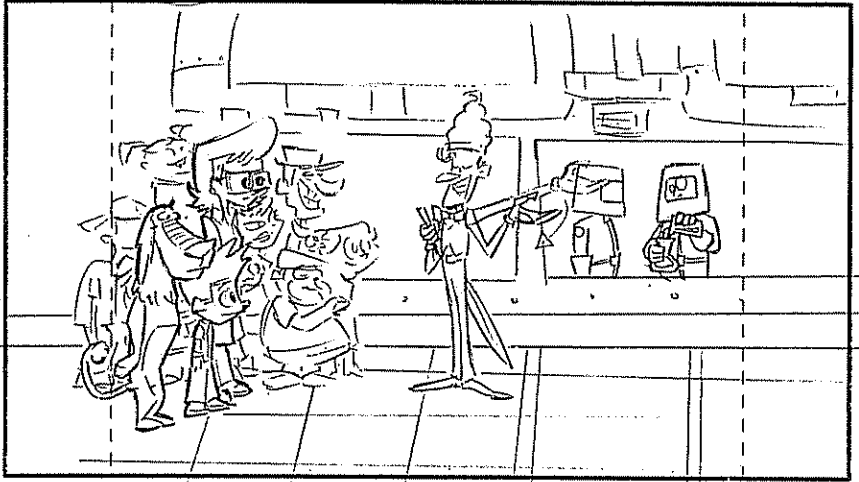

ACTION

CUT WIDE: SCIENTISTS MIX CHEMICALS BEHIND A GLASS SHIELD..

RE-DRAW

SCENE

2/2 BG

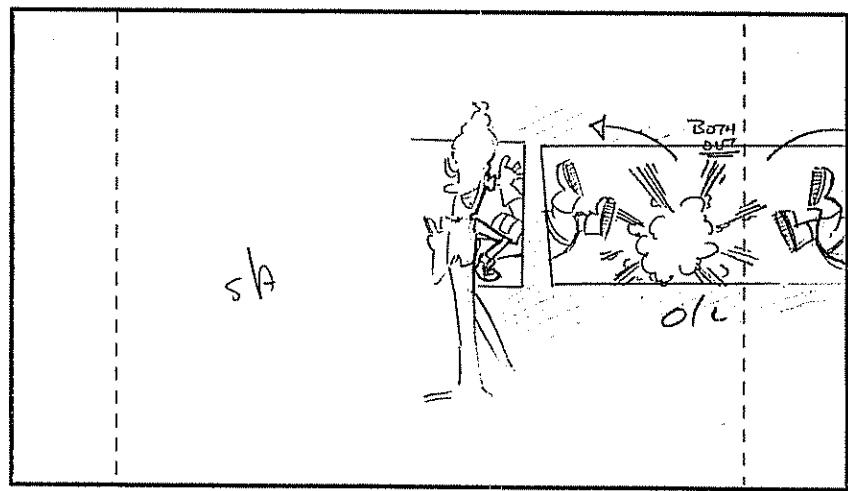

- THE CHEMICAL EXPLODES
- NO ONE REACTS..

DIALOGUE

49. TOUR GUIDE
Right here. Where our scientists are creating chemicals like Riboflavin

SFX:
(BOOM!)

NOTES



2023



Re - draw

EPISODE: _____ PAGE: 100

SCENE (101)

1/4 BG



ACTION

cut

SCENE

2/4 BG



SUSAN STEPS CLOSER TO GUIDE.

DIALOGUE

(49) TOUR GUIDE: (CONT)
AND TRACK A FILLABLEMENTS
THAT GIVE OUR ICE CREAM IT'S
COLOUR AND ARTIFICIAL FLAVORS.

50. SUSAN
Hey, what's that over there?

NOTES



© 2006 Johnny Test Productions Inc "Johnny Test" TM Warner Bros Entertainment Inc. All Rights Reserved.

collideoscope animation studios

2023



SCENE 101 CONT'D 3/4 BG



ACTION

- ① - SUSAN STEPS BACK
- ② - GUIDE LEANS FORWARD / LOOKS PAST SUSAN / MARY
- ③ - SUSAN / MARY RACE DE RT!

SCENE 4/4 BG



- JOHNNY & DUCKY IN.

DIALOGUE

51. TOUR GUIDE
OOH, ... That's called

NOTES





2025

PAGE: 101A

(102) - NEW SC.

SCENE

(101A)

PANEL

1/1

BG

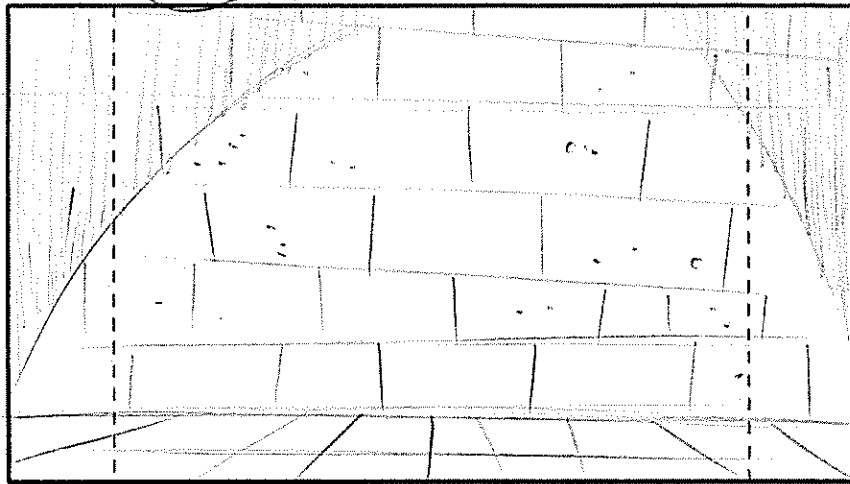

SCENE

PANEL

BG

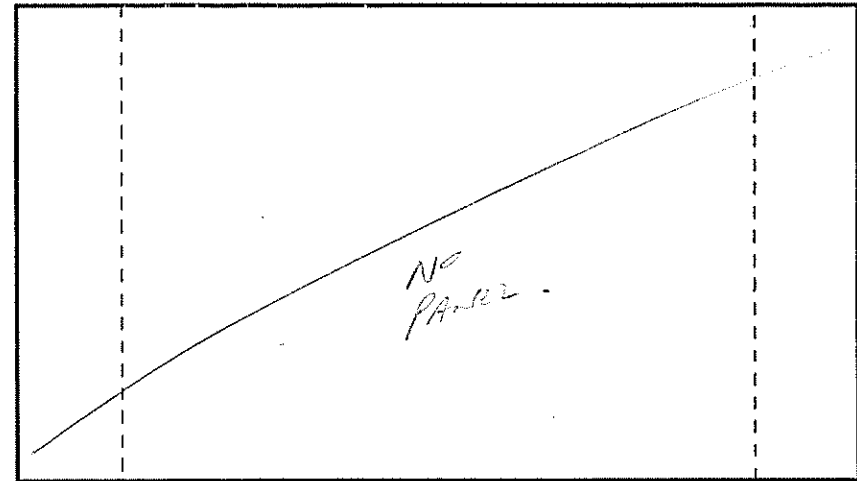

ACTION

(cut) TO WALL.

DIALOGUE

TOUR GUIDE = (♣) - CONT'D
... A "WALL"!

NOTES



202B



Re - Panel #15

EPISODE: _____

PAGE: 102

Re - Panel #15

SCENE 102

1/3

BG



SCENE

2/3

BG

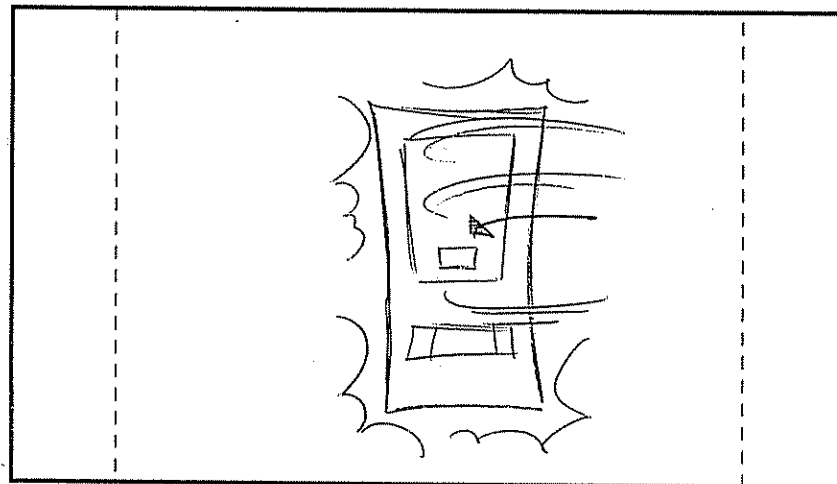

ACTION

W - DOWN THE HALLWAY, SUSAN/MARY
HAVE ENTERED THE LAB (BG from SC#100)

- AND SLAM THE DOOR SHUT..

DIALOGUE

SFX:
(SLAM!)

NOTES



© 2006 Johnny Test Productions Inc "Johnny Test" TM Warner Bros Entertainment Inc. All Rights Reserved.

 colidea scope animation studios

202 B

Pages 103, 104 out!!



(K2) - VIS/NEW PANEL

*NO SC 103-106!

EPISODE: _____

PAGE: 105

(K2) - Action

SCENE 102 CONT'D PANEL 2/3

BG

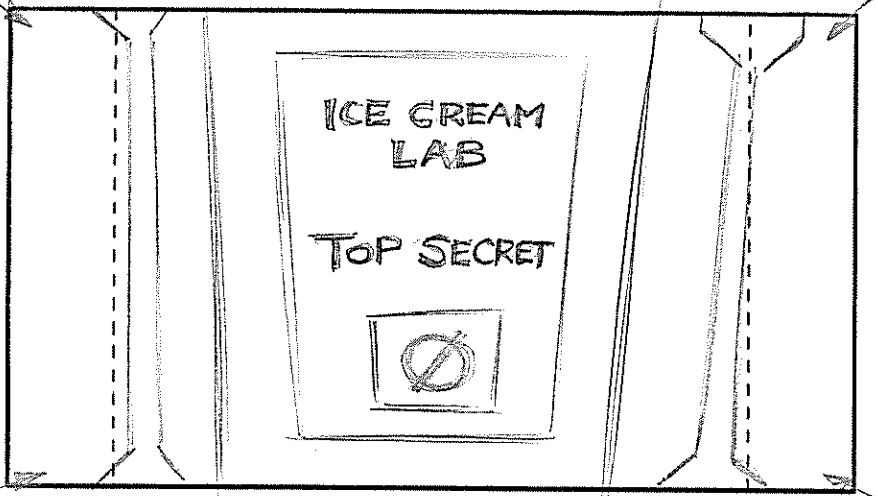

ACTION

SNAP TRK-IN CLOSE ON SIGN ON DOOR.

DIALOGUE

NOTES

SCENE 107

BG

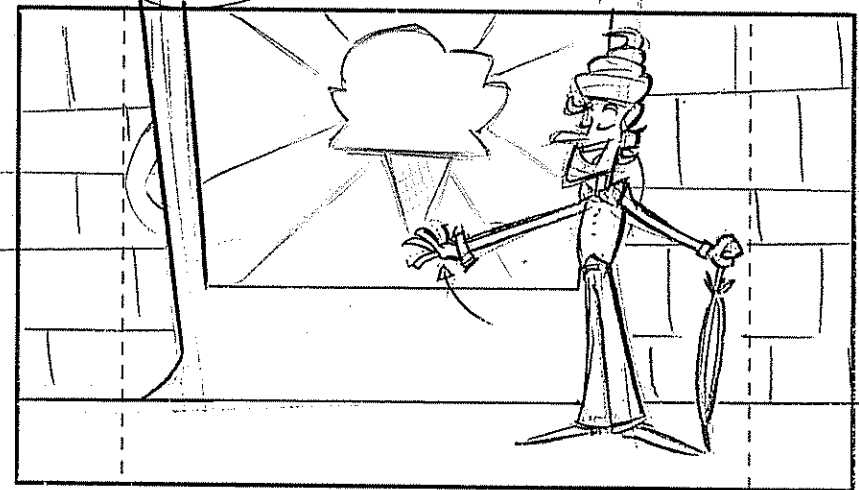

WT

- THE TOUR CONT.

- GUIDE STANDS BEFORE A LARGE WINDOW.

54. TOUR GUIDE

Next up is where we make our FAMOUS MEGA-MINT CHIP!

LAYOUT NOTE DESIGN SHOULD BE WINDOW, NOT DOORWAY



202B



EPISODE: _____

PAGE: 106

SCENE (108)

BG



ACTION

- J ; D ~~W~~
LOOK UPON
EACH OTHER ..

SCENE (109)

BG

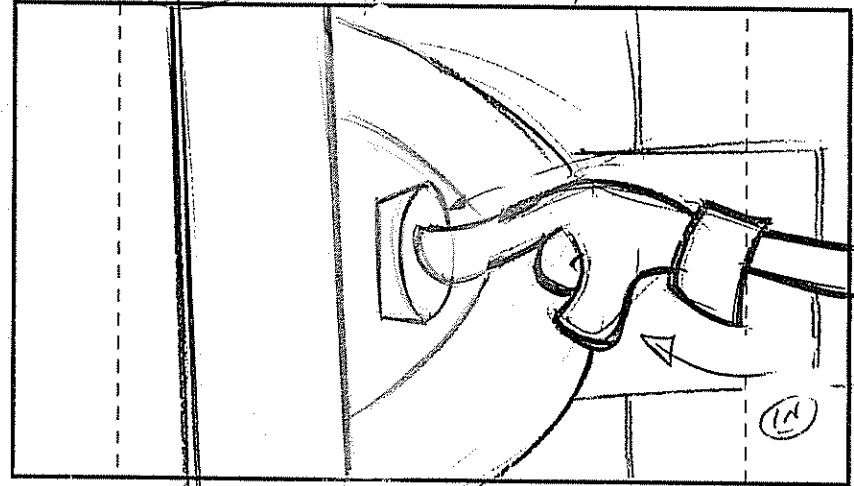

- CLOSE TO BUTTON
- GUIDE'S HAND IN & PASSES BUTTON.

DIALOGUE

NOTES



202B



SCENE (110)

1/2 BG

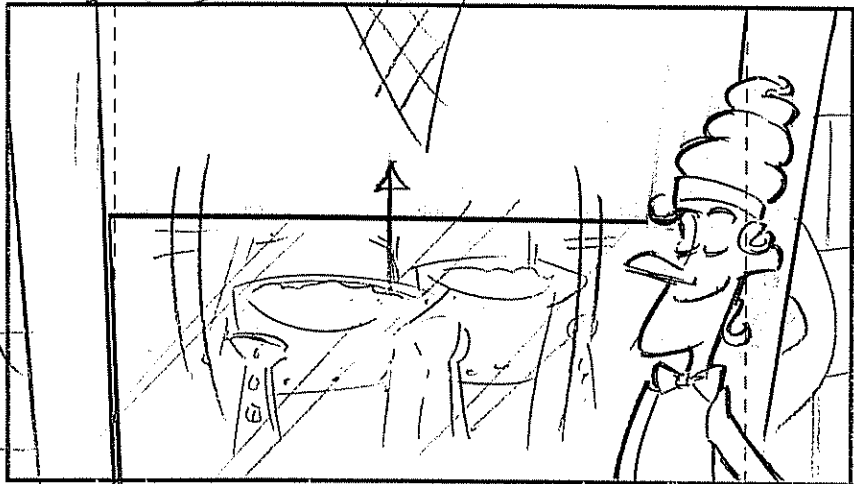

SCENE

2/2 BG

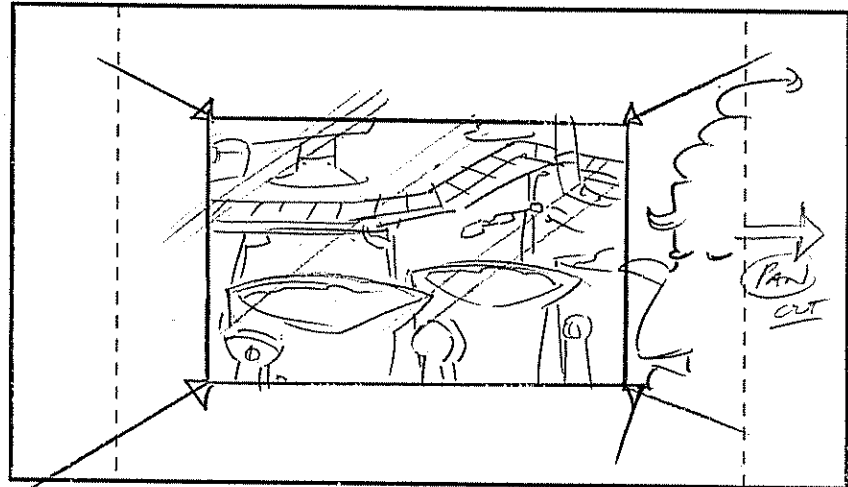

ACTION

CUT

- THE DOOR SLIDES OPEN.. AND BEHIND A GLASS WINDOW IS THE GREAT FACEMAN REVEALED

- PAN GLIDE OUT (RT) PUSHING TRK-IN!

DIALOGUE

NOTES



202B

*No Sc III!

*Pg. 108 cut!

JOHNNY
SCENE 112

R2 - DIRL.

BG

EPISODE: _____

PAGE: 109

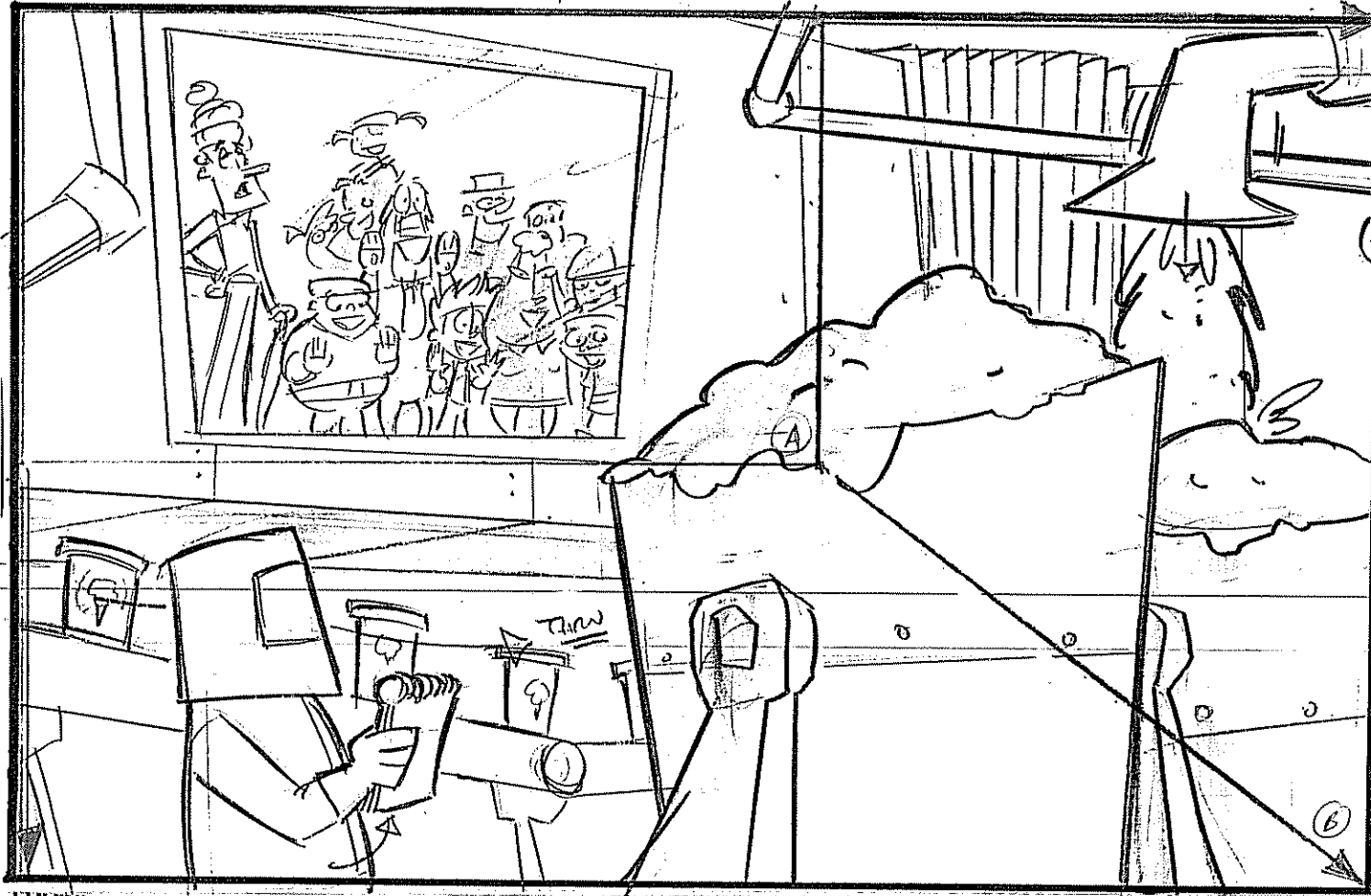

(cut) to Glass AT
Window
-TRK-cut at
FACTORY
(A) → (B)

DIALO

55. TOUR GUIDE (cut to)
and Banana-mana Monkey Chunk.

LUCKY
JAR

© 2006 Johnny Test Productions Inc "Johnny Test" TM Warner Bros Entertainment Inc All Rights Reserved.

▼ tom@scopeanimationstudios.com



202B

(12 - now so!

SCENE (112A) PANEL 1/1 BG

DUKE!

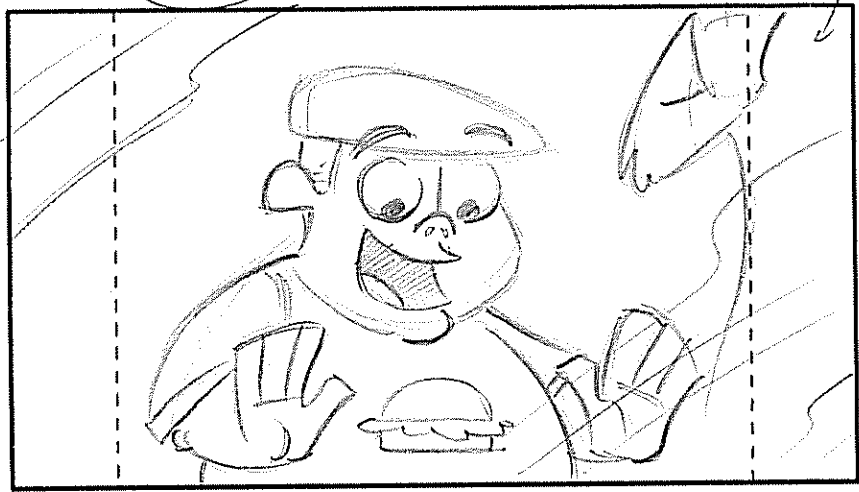

SCENE PANEL BG

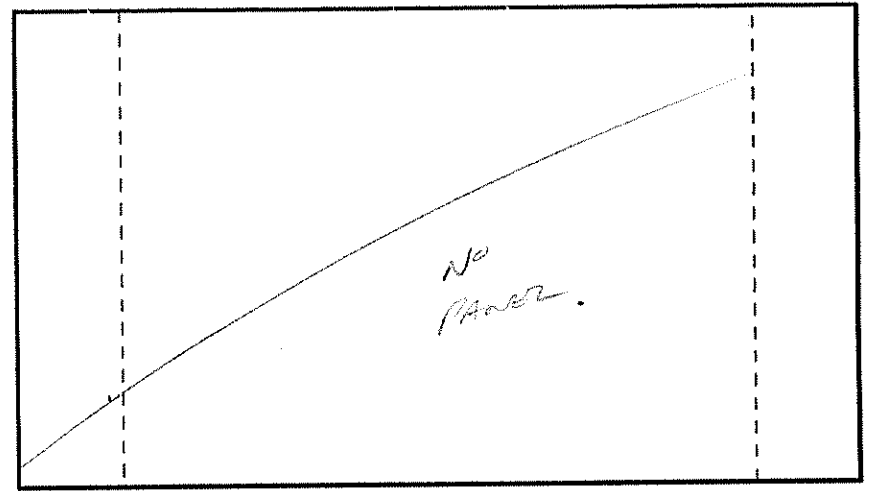

ACTION

(CUT TO H.U.)

CLOSE UP CHASE / K.O

DIALOGUE

(50) CHASE / -
IS IT MADE WITH REAL MONKEYS?

NOTES



2-2B

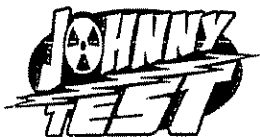

EPISODE: _____

PAGE: 110

SCENE (113)

BG



SCENE (114)

BG

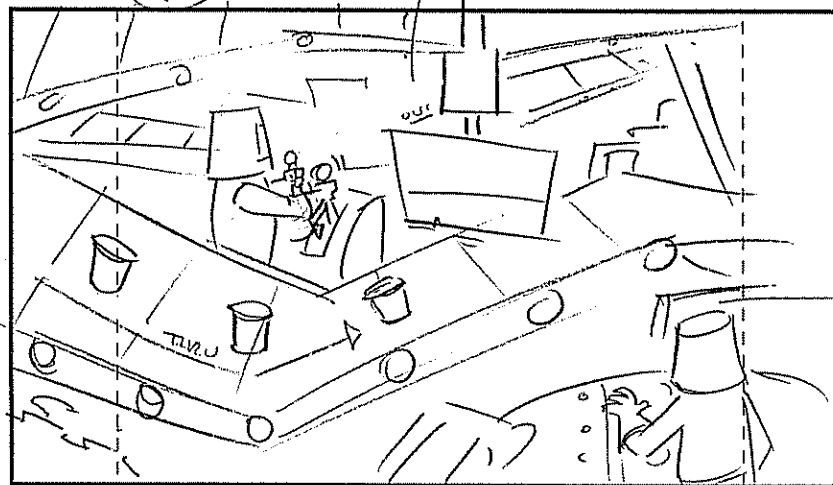

ACTION

(cut) on GUIDE

(cut) - THE FACTORY IS IN FULL SWING..

DIALOGUE

57. TOUR GUIDE
No. Of course not. It's just a...

CONST'D TOUR GUIDE:
... CATCHY NAME THAT OUR FOCUS GROUPS
CAME UP WITH...

NOTES



202B



pe - DIAC.

EPISODE: _____

PAGE: 111

SCENE (115)

BG

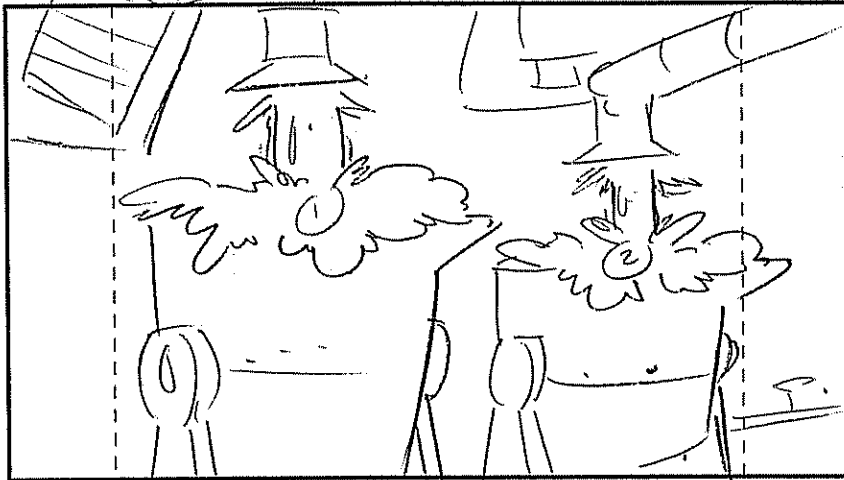

ACTION

(cycle)

ICE CREAM IS DUMPED INTO VARS (ALTERNATE/CYCLE)

DIALOGUE

(ST) TOUR GUIDE: (CONT'D)
...to appeal to the ice cream consumer. HA, HA, HA.

NOTES



© 2006 Johnny Test Productions Inc "Johnny Test" TM Warner Bros Entertainment Inc

pe - DIAC.

SCENE (116)

BG

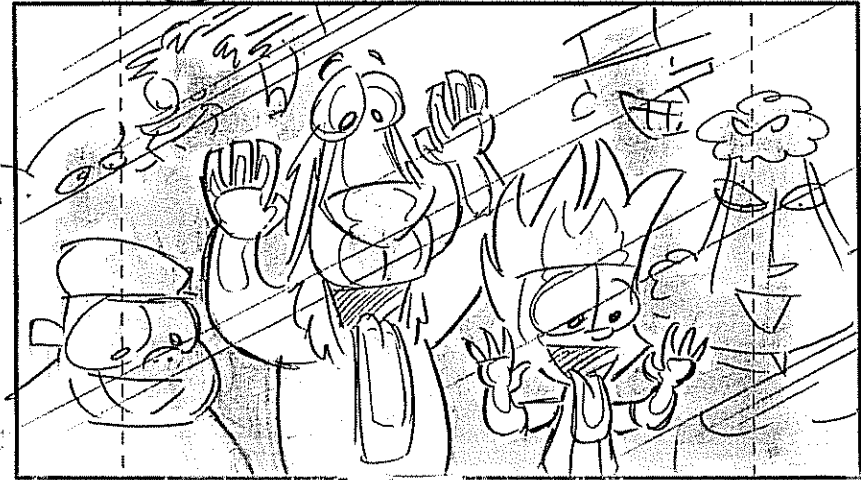

(cut)

- TOUR LOOKS THROUGH WINDOW.

(WIPE CUT ->)

DIAC:

(ST) TOUR GUIDE: (CONT'D)
NOW, LET'S MOVE ALONG.

SCENE (117)

PANEL 4

BG

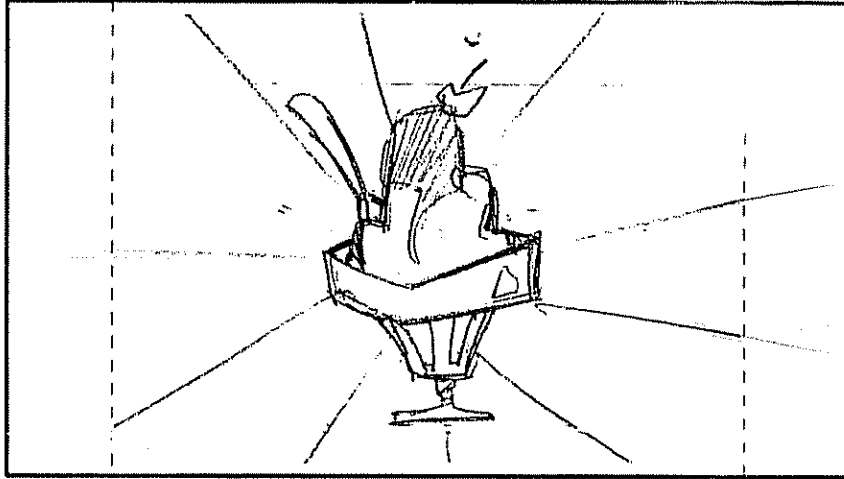

ACTION

ICE CREAM WIPE

SCENE

PANEL

BG

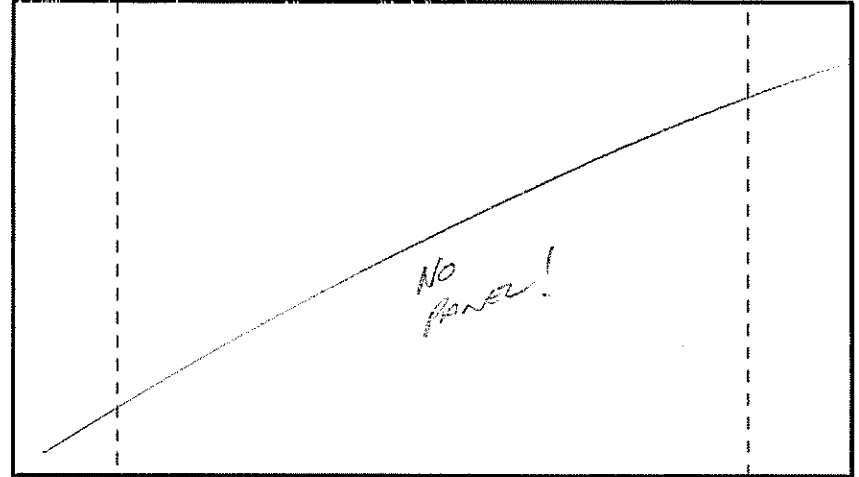

DIALOGUE

NOTES

2-2B



SCENE (118)

$\frac{1}{2}$ BG

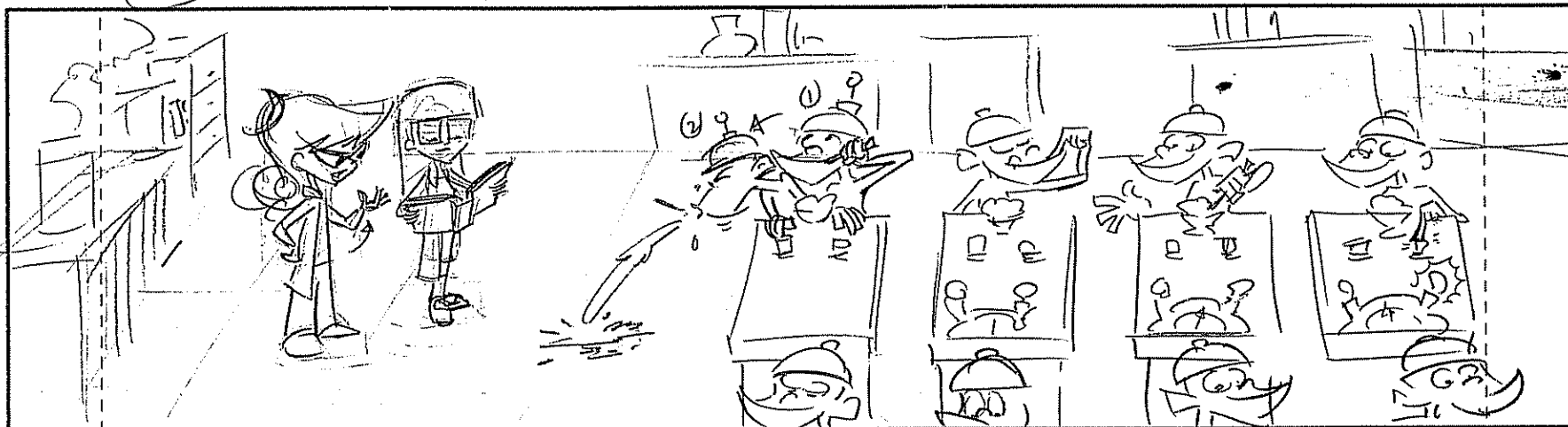

ACTION

WIP
IN

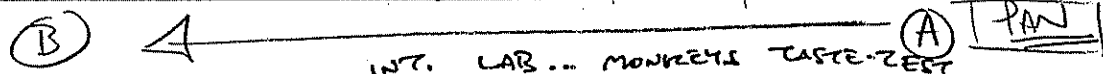

INT. LAB ... MONKEYS TASTE-ZEST ICE CREAM ..

... SUSAN & MARY LOOK ON..

DIALOGUE

5B. MARY
It appears to be a tasting lab and the monkeys are the tasters.

NOTES



202B



(RZ-DIAL)

EPISODE: _____ | PAGE: 113

*No Sc119!

(RZ-PANOR)

SCENE 118 CONT'D 2/2 BG

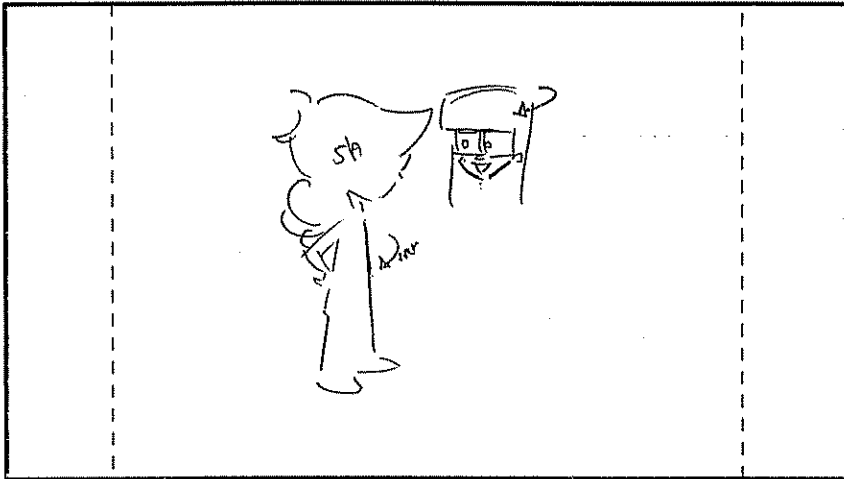

SCENE 120 1/2 BG

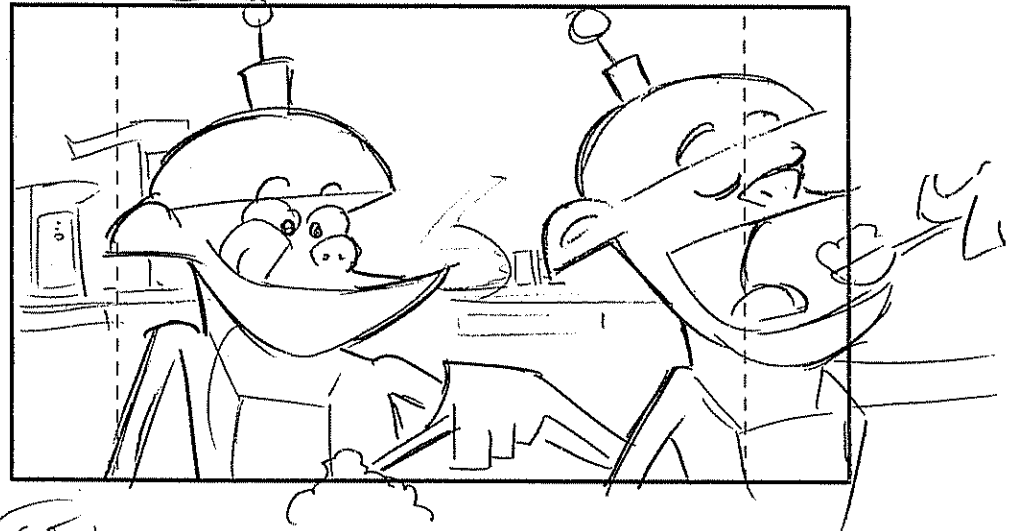

ACTION

CONT.

CLOSE ON MOMENT EATING
ICE CREAM..

DIALOGUE

59. SUSAN
With this secret recipe
book we can make our healthy ice cream

(59) Susan: (cont'd) o/s
and see if it's good enough

NOTES



(R2) - VIS -
- DIRT

SCENE 120 cont'd PANEL 3/2 BG

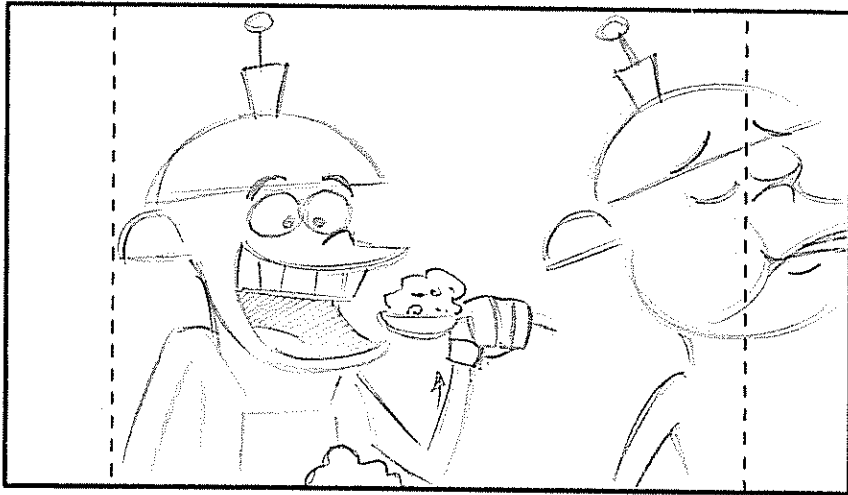

ACTION

SCENE PANEL BG

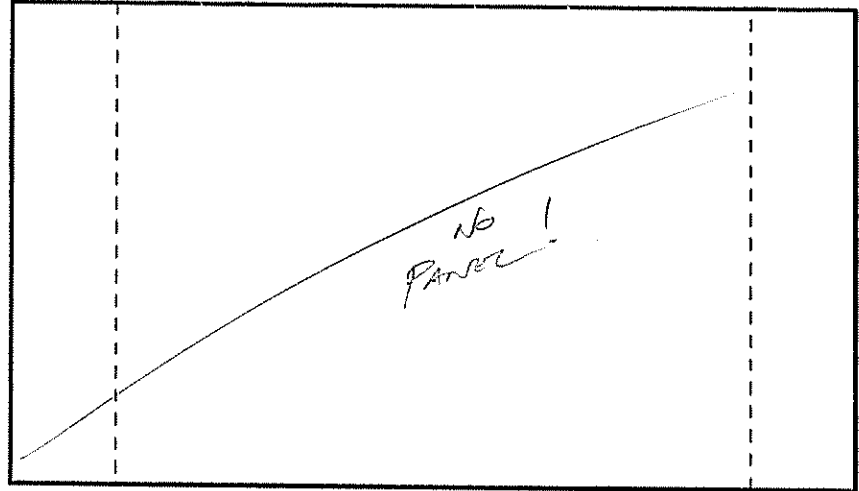

DIALOGUE

SUGAR: (cont'd)
... TO GET AN "A" BY THE ...

NOTES

202B



EPISODE: _____

PAGE: 114

SCENE (12.1)

BG



ACTION

CUT BACK TO SUSAN & MARY..

SCENE

BG



* WIPE TO:

WIPE OUT →

DIALOGUE

Susan: (Cont'd)
TESTS - TESTING, professionals!

60. MARY
Let's get to work!

NOTES



© 2006 Johnny Test Productions Inc. "Johnny Test" TM Warner Bros Entertainment Inc. All Rights Reserved

collidescope animation studios

SCENE (121A)

PANEL

4

BG

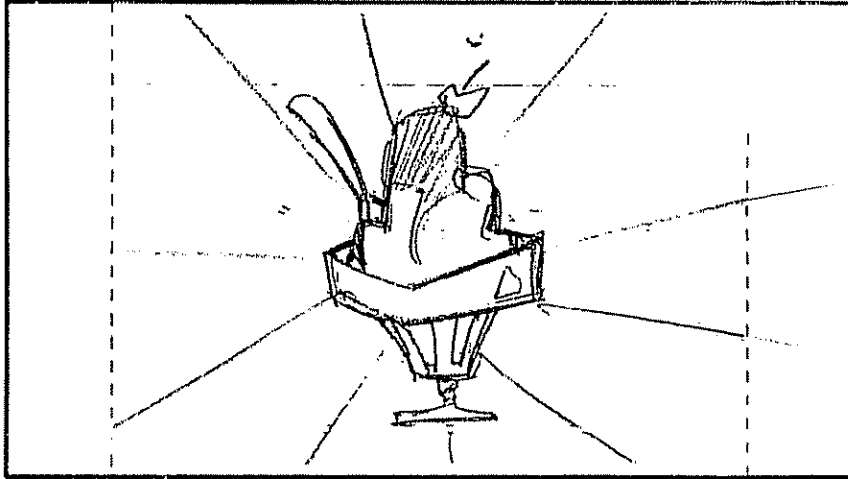

ACTION

ICE CREAM WAPE

SCENE

PANEL

BG

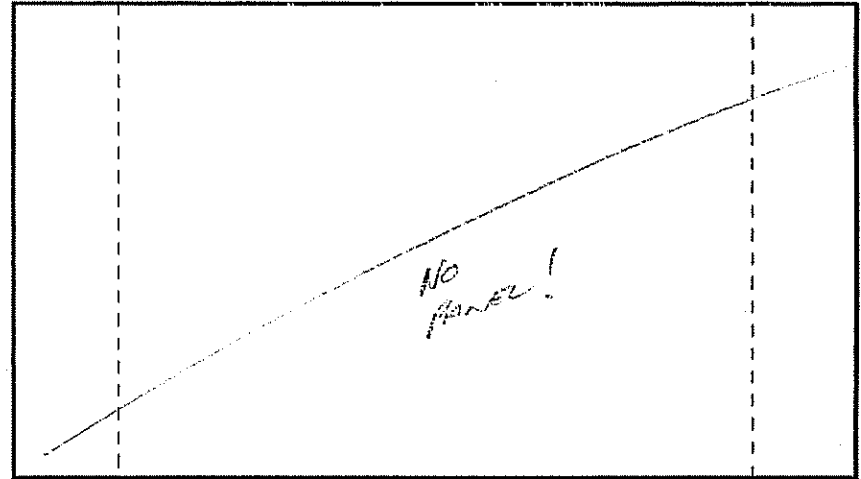

DIALOGUE

NOTES



(RZ) - DIAL

EPISODE: _____

PAGE: 115

202B

SCENE 122

BG

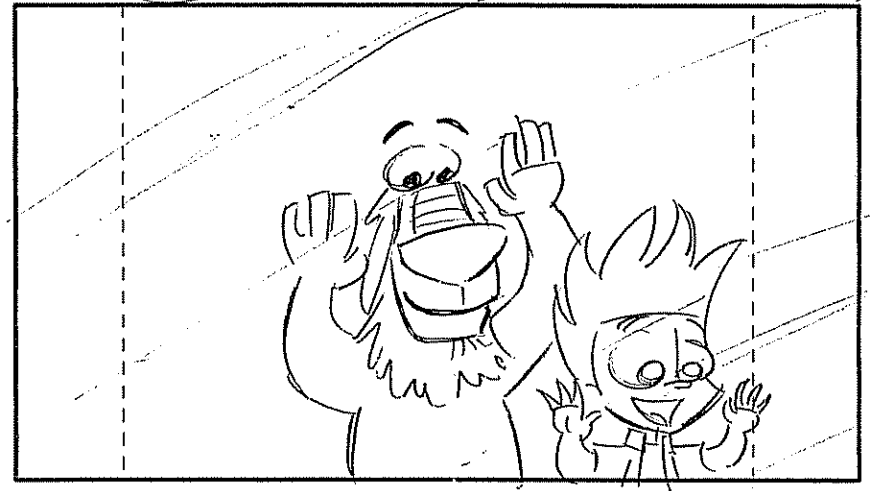

ACTION

Wipe in - J & D REMAIN BEHIND THE GLASS WINDOW (NO TOUR GROUP)

DIALOGUE

61. JOHNNY
Look at all that mint chip

NOTES

SCENE 123

BG

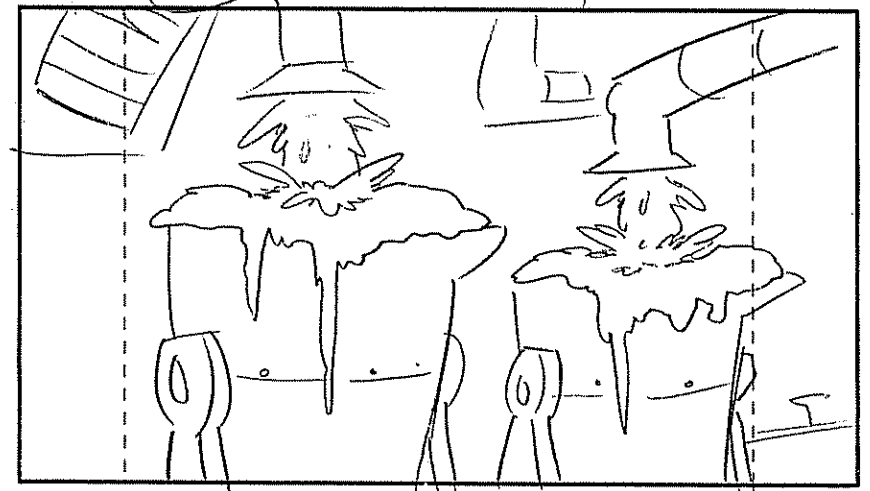

cut - MOVE ICE CREAM (SEE SC# 115)

(GZ) DIAL: (O/S)
DON'T EVEN THINK ABOUT IT Johnny, ...



(P2) - PANELS
 (P2) - VIS.
 - DIAL.

(P2) - DIAL

SCENE (124) PANEL 1/3 BG

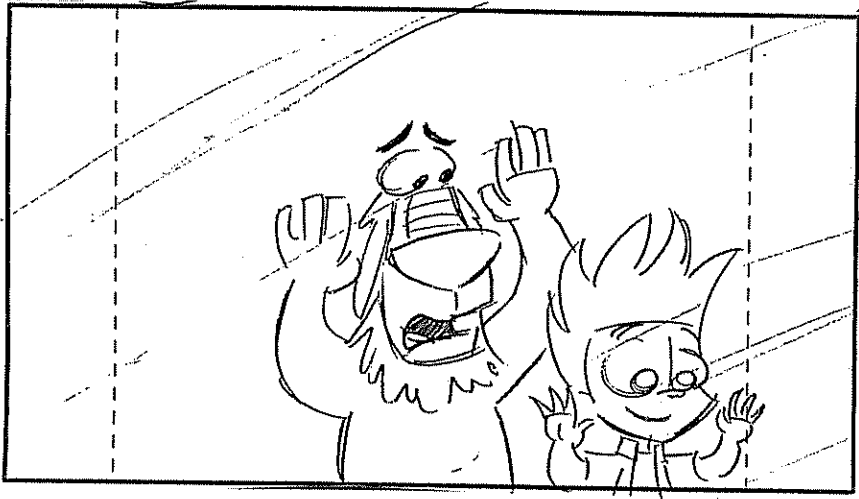

ACTION
 (W) BACK TO DORCEY & JOHNNY

SCENE PANEL 2/3 BG



TOUR GUIDE ENTERS.

DIALOGUE (62) DORCEY = (CONT'D)
 ... BLENDING INTO THAT PART OF THE
 FACTORY FEELS LOUSY DANGEROUS.

(63) TOUR GUIDE =
 THE PINK AND BROWN SWIRL VAT...

NOTES

202B



(R2) - V.S. - D.M.

EPISODE: _____ PAGE: 116

(R2) - DIRE.

SCENE 124 cont'd 3/3 BG



ACTION

SCENE 125 1/2 BG

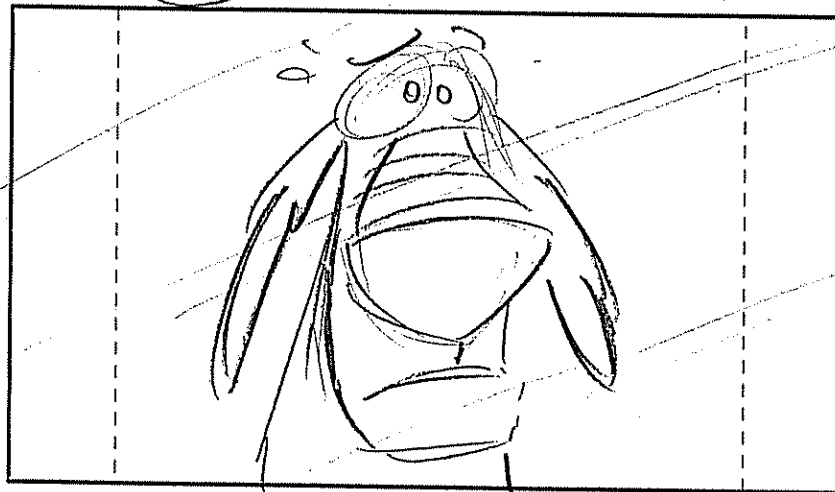

(W) - CLOSE ON DUCKY..

DIALOGUE

63. TOUR GUIDE

is a flavor we're experimenting on
CALLED ...

(63) TOUR GUIDE: (cont'd ds)
- STEAK WITH GRAVY.

NOTES



202B



EPISODE: _____ PAGE: 117

SCENE 125 Cont'd 2/2 BG

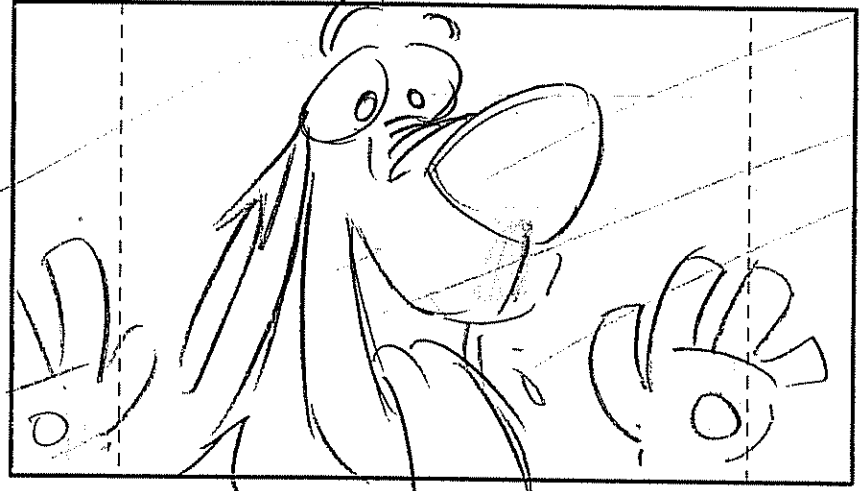

Sc 126
art!

ACTION

- REACTS -

DIALOGUE

None
AHHH...

NOTES



202B



SCENE 127

BG

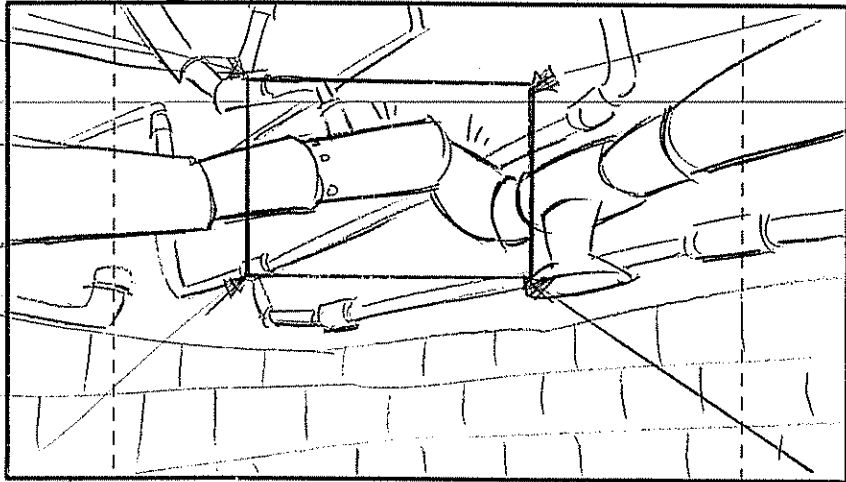

SCENE 128

BG

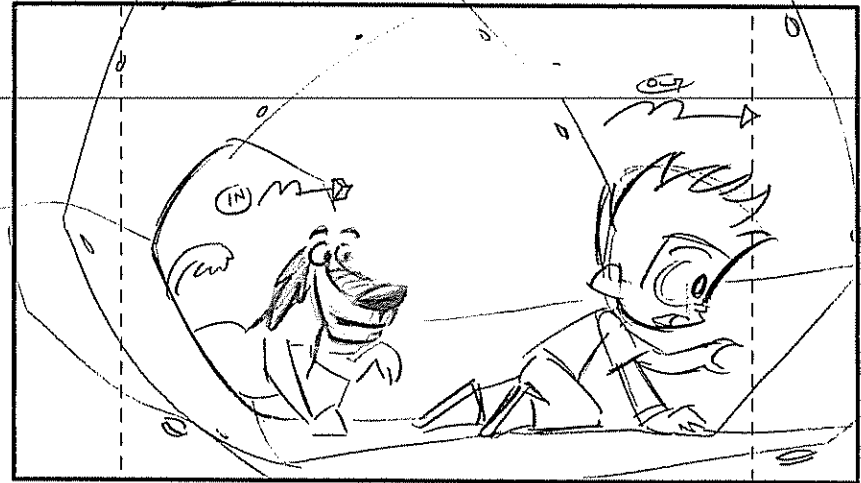

ACTION

cut - INT. FACTORY (CEILING)
- ZOOM ON OVERHEAD PIPES

cut - J & D MAKE THEIR WAY THRU THE DUCTS..

DIALOG

(64) *Duke*: (6/5)
DO YOU EVEN KNOW WHERE WE'RE GOING?

Yes. No. 65. JOHNNY

NOTES



252B



R2 - VIS
- ACTION
- D.M.C.

R2 - VIS
- D.M.C.

SCENE (129)

BG

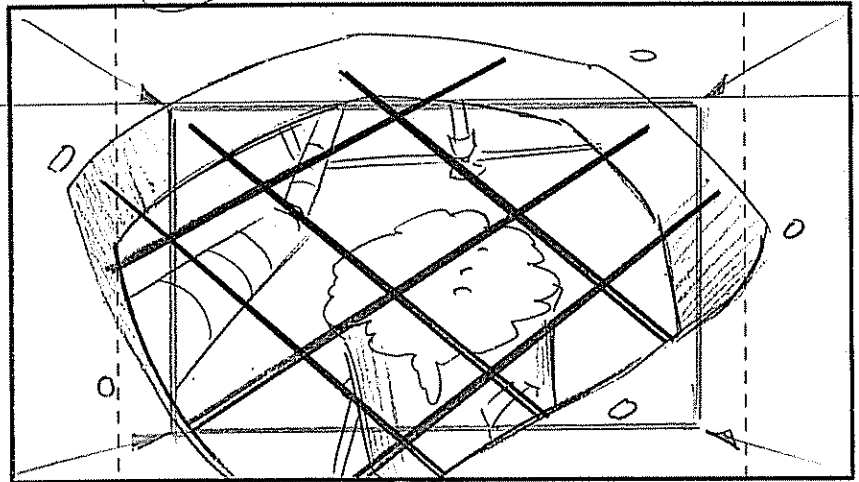

SCENE (130)

BG



ACTION

- J & D; POV.

(CUT)

- TARD THE VENT; THE FACEM BELOW!
- TRIL-IN SLOWLY!

(CUT) TO Johnny & Darcy

DIALOGUE

SEX: (SHEEP)
CONFID

66. JOHNNY

Yes! Now all we have to do is gently lower ourselves below...

(66) Darcy (CONFID)

AND it's ice cream heaven.

NOTES



2023



Re - VIS
- DIAL.

EPISODE: _____ | PAGE: 120

SCENE 130 Confid

2/3

BG

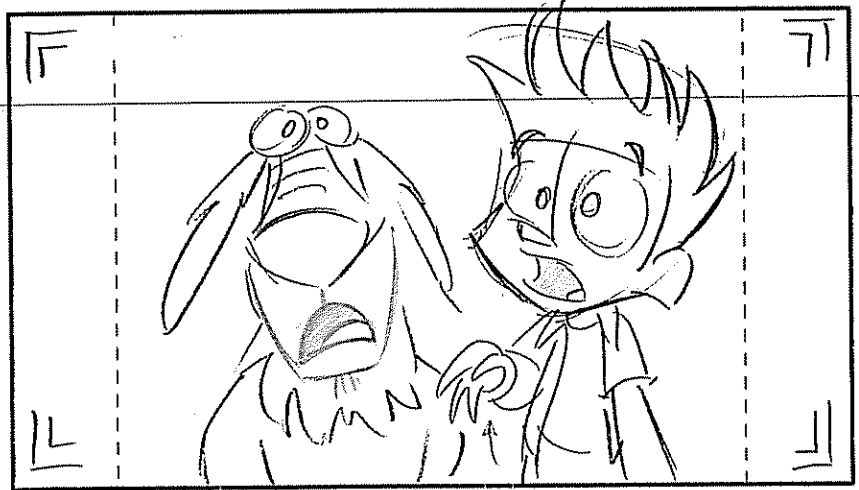

SCENE

2/3

BG

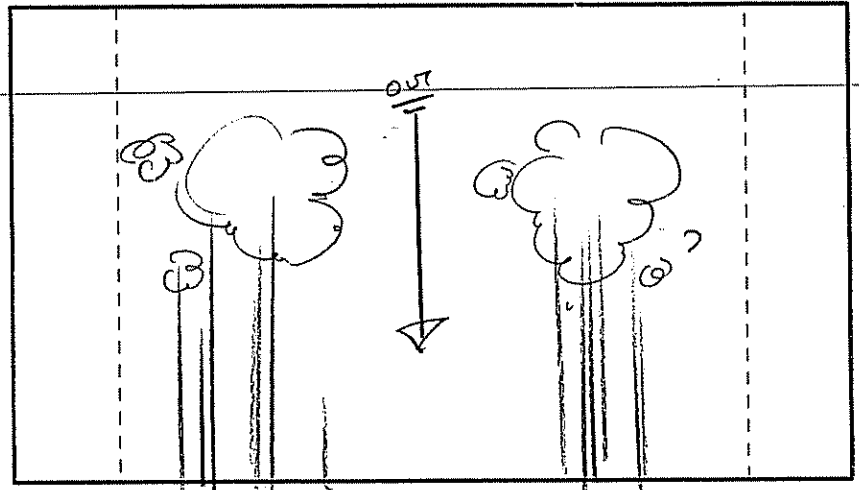

ACTION

- CAMERA PANS
- THEY REACT!

- THE DWO FALL OUT
of frame...

DIALOGUE

SFX:
(BIG MACHINES!)

(66A) Johnny/Denny:
AHHH!

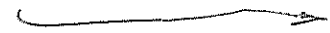

NOTES



202B



(12) - PANELS

EPISODE: _____ | PAGE: 121

SCENE (130A)

BG

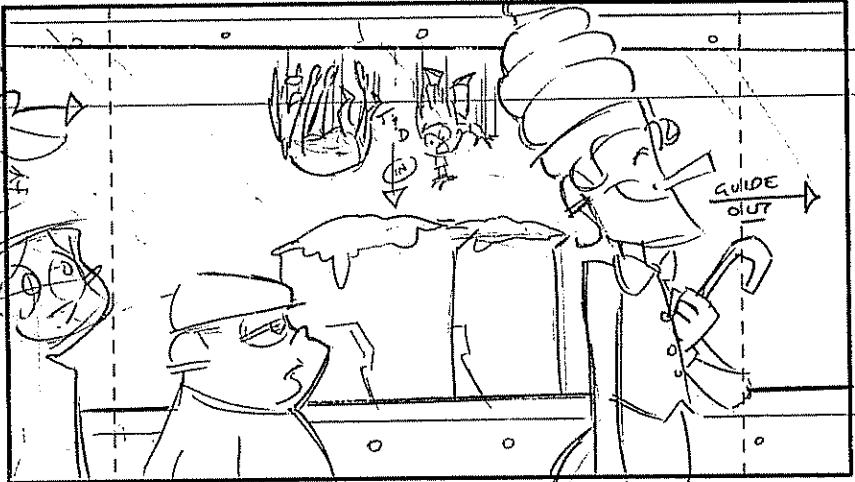

SCENE

BG

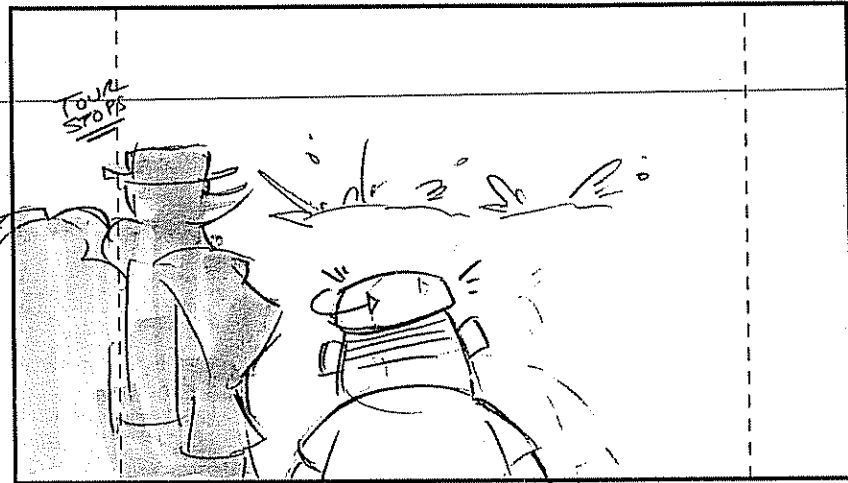

ACTION

(CUT)

- THE TOUR CONT. PART ~~BE~~ MORE
GLASS WINDOWS -- INSIDE THE
IMMEDIATE FACTORY, J & D FALL INTO FRAME .. AND LAND IN THE VATS BELOW.

- CHUBBY KID TURNS
TOWARD THEM (BEAT)
AND ASKS:

DIALOGUE

Johnny/Duke - (CONT'D)
AAAAH!

67. CHUBBY KID
Are you sure you don't use real

NOTES





202 B

KNOW PG.

PAGE: 121A

(63) - VIS. - DIAL.

(68) - DIAL.

SCENE 130A CONFID PANEL 3/6 BG

SCENE PANEL 4/6 BG

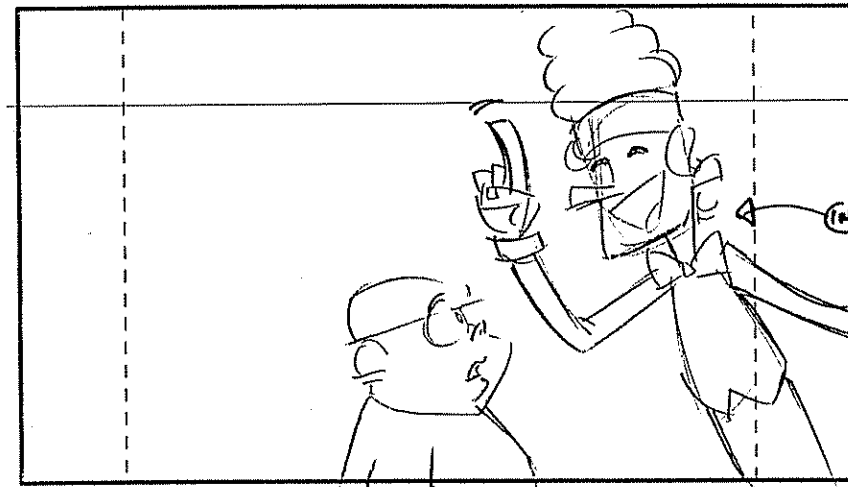
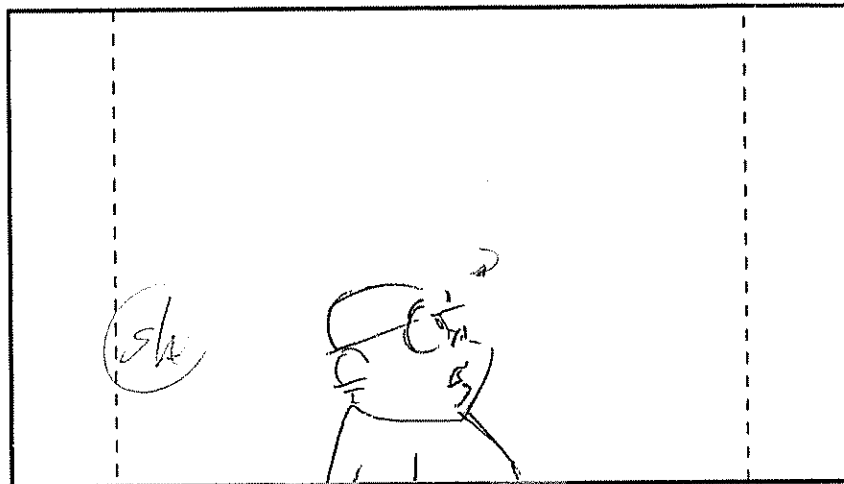

ACTION

KID TURNS CW.

TEAR GUIDE IN.

DIALOGUE

(67) CHERRY/KID: (CONFID)
... MONKEYS IN THE MONKEY CHAIR?

(68) TEAR GUIDE:

YES, IT'S JUST A CLOWD
REFERENCE TO THE BANANA ICE
CERAM AND ...

NOTES





202B

* New PG.

PAGE: 121B

(Re - DIRE.)

(Re - VIS - DIRE.)

SCENE BOA CONT'D PANEL

5/6

BG

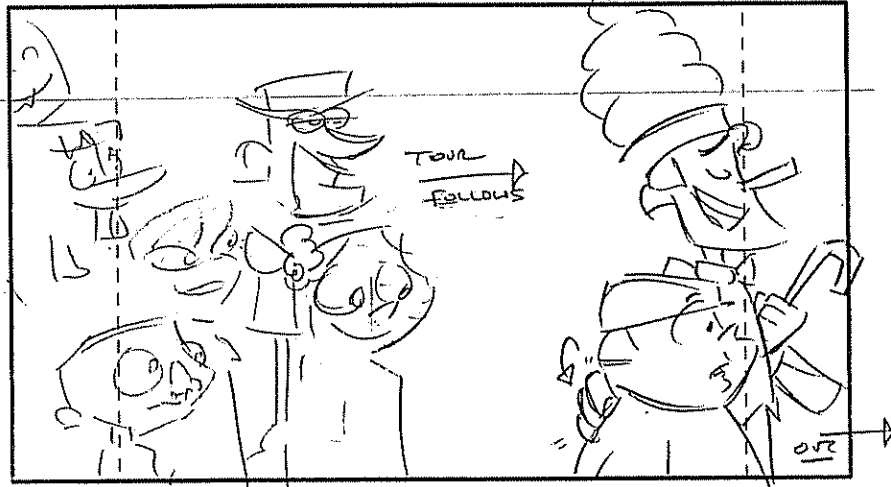

SCENE

PANEL

6/6

BG



ACTION

TOUR GUIDE LEADS GROUP OUT →

DIALOGUE

Tour Guide: (cont'd)

... I PROMISE NO MONKEYS ARE HARMED HERE ...

Tour Guide: (cont'd)

... AT THE FACTORY.

NOTES



SCENE **(131)**

BG

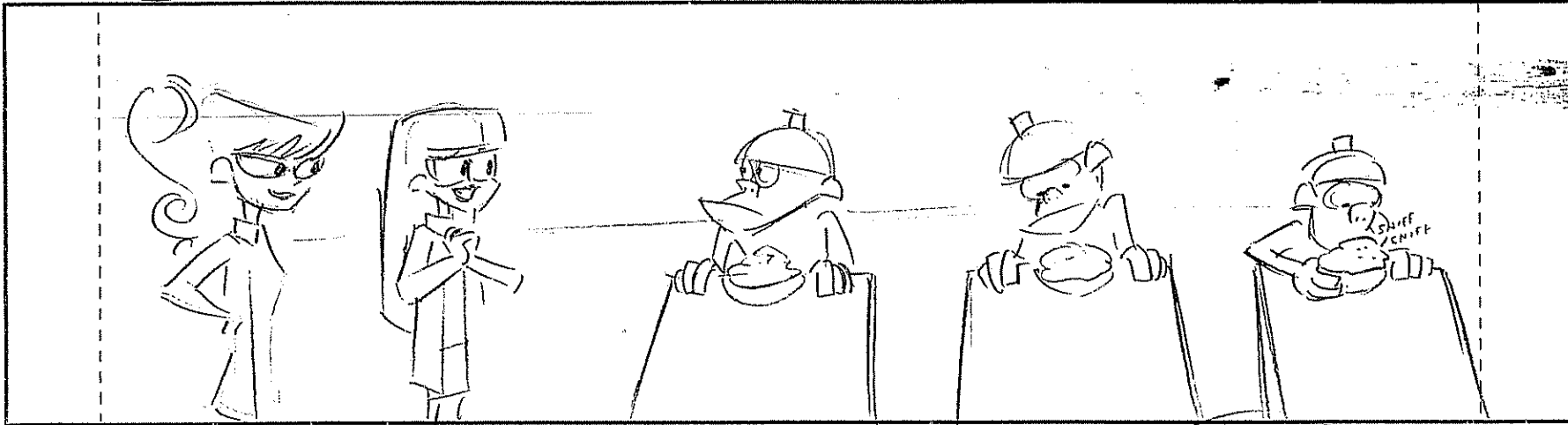

ACTION

CS

**- THE TWINS
ARE ELATED ..**

- 3 MONKEYS LOOK UPON SUSAN & MARY'S CONCOCTION ..

DIALOGUE

69. SUSAN
Okay, let's see if they like our
new recipe.

NOTES

202B



EPISODE: _____

PAGE: 123

SCENE (132)

1/5 BG

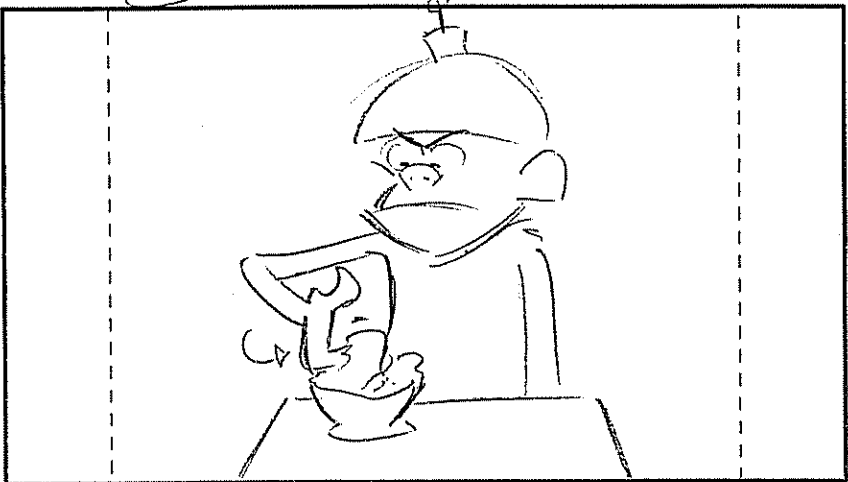

SCENE

2/5 BG



ACTION

~~-(CUT) CLOSE ON ONE OF THE MONUMENTS HE TASTES THE ICE CREAM~~

DIALOGUE

NOTES



2023



PG - DIAL.

EPISODE: _____ PAGE: 124

SCENE 132 CONT'D 3/5 BG



SCENE 4/5 BG

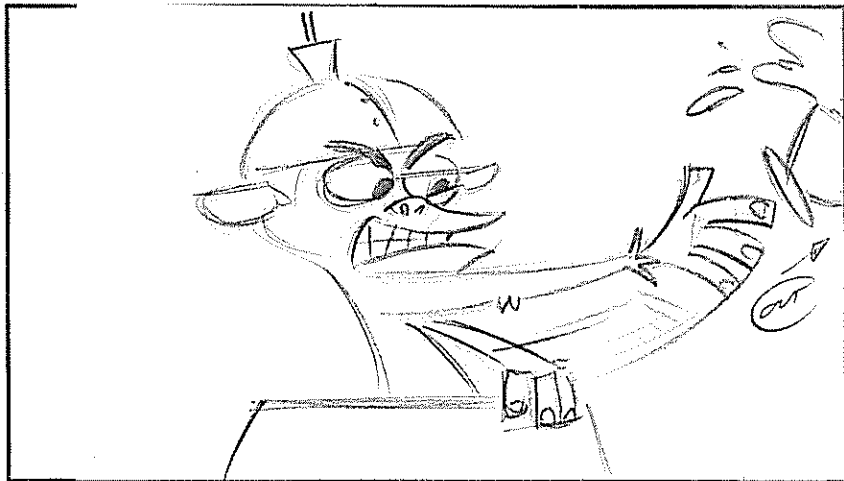

ACTION

- GASPS ON IT'S PUTRID TASTE... AND SWATS THE VILE GUEL AWAY...

DIALOGUE

McNefs -
(SWEET!) ~~~~~

NOTES



252B



RZ. DIAZ.

EPISODE: _____

PAGE: ~~124~~
125

RZ. DIAZ.

SCENE 132 cont'd 5/5 BG



ACTION

- THE MONKEY REACTS VIOLENTLY..

SCENE 133



CUT

SUSAN & MARY DODGE BOWLS OF ICE CREAM..

DIALOGUE

MARY(S) : (cont'd)
(SCREAM!) →

70. MARY
AH...I'll take THAT as a no.

NOTES



2023



SCENE 133 cont'd 2/2 BG

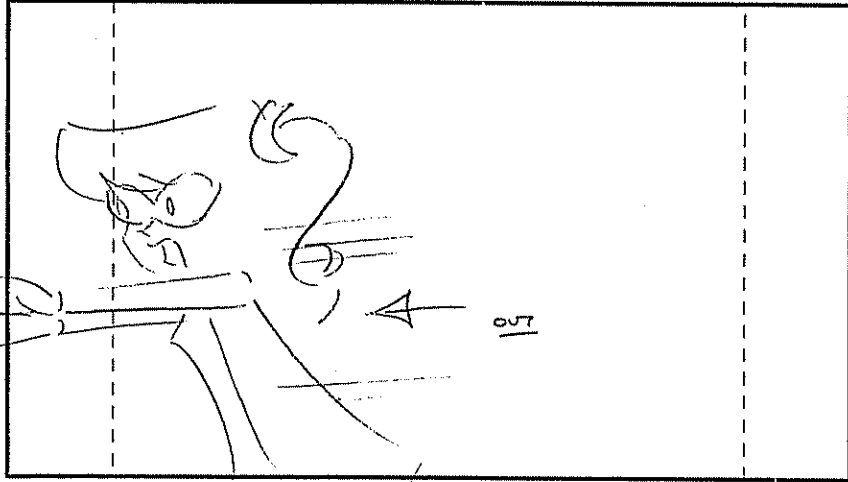

ACTION

- AND ESCAPE ..

WIPE OUT →

SCENE 134 1/1 BG

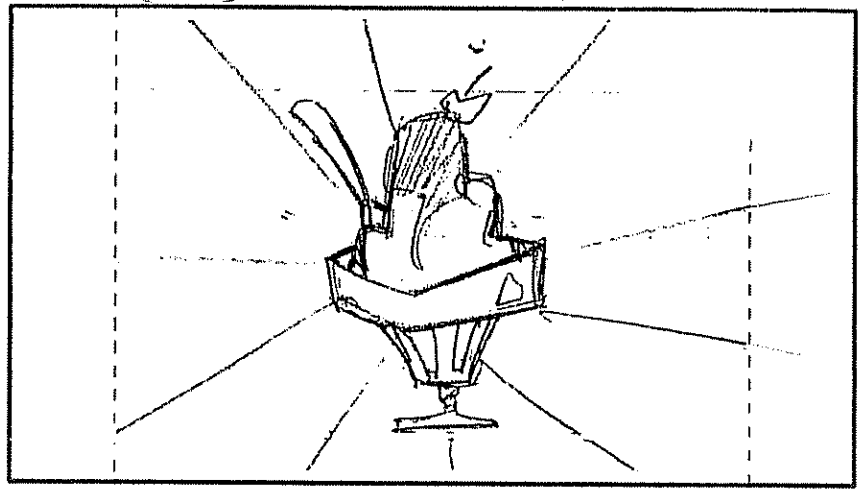

ICE CREAM WIPE

DIALOGUE

NOTES



202B



SCENE 135

SCENE

2/6

BG

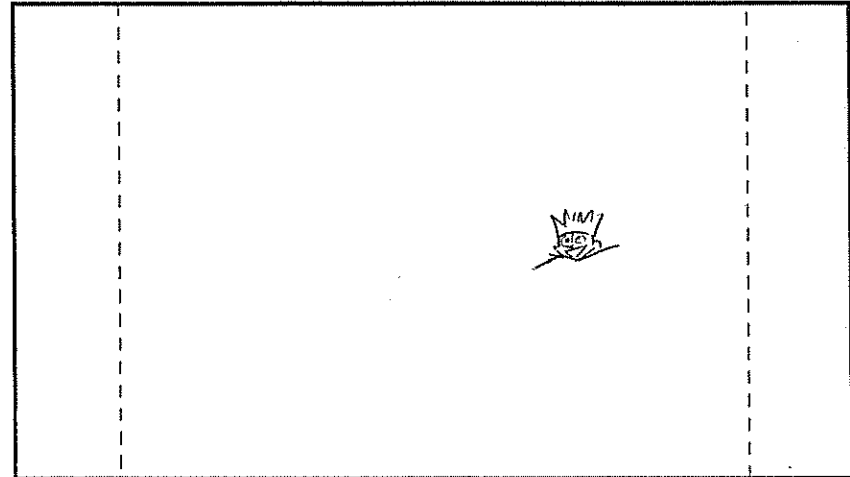
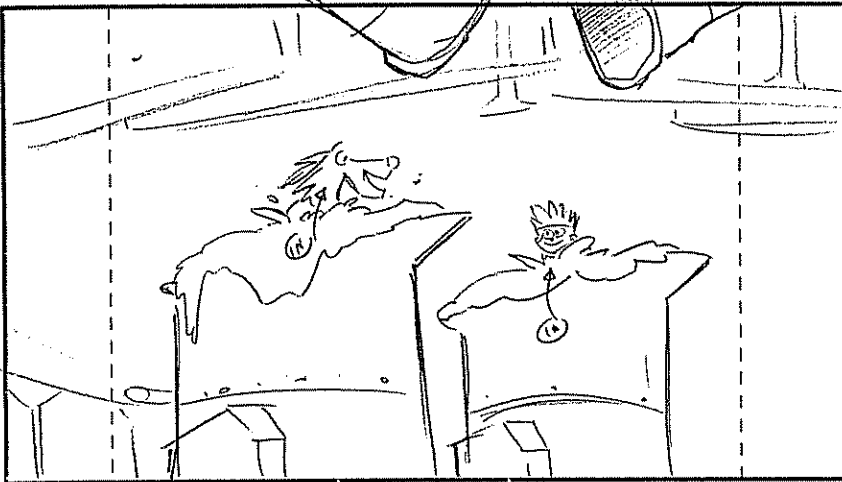

ACTION

WIPE IN

BACK AT THE HEART OF THE FACON...

J & D RISE FROM WITHIN GIANT ICE CREAM VANS ...

DIALOGUE

71. DUKEY
UH HUH, UH ... Johnny, you gotta try this! UH! ...

72. JOHNNY
Ice cream switch!

NOTES



202B



SCENE 135 cont'd 3/6 BG

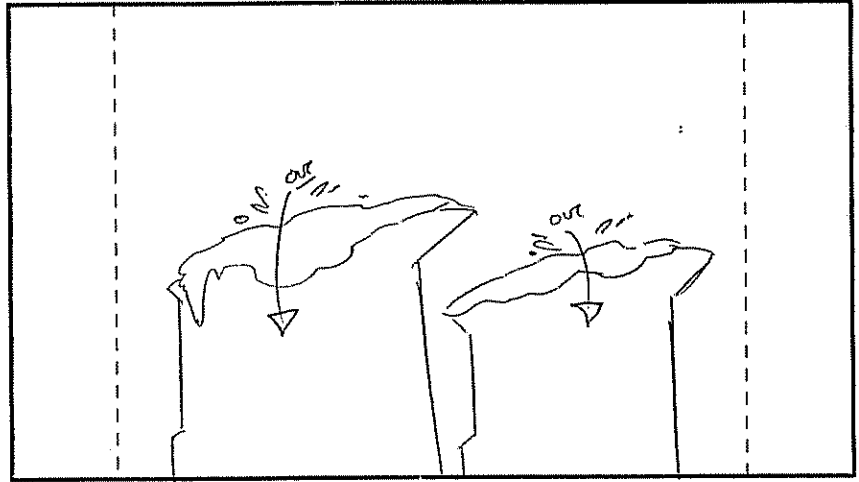

ACTION - THEY DUCK DOWN..

SCENE 4/6 BG

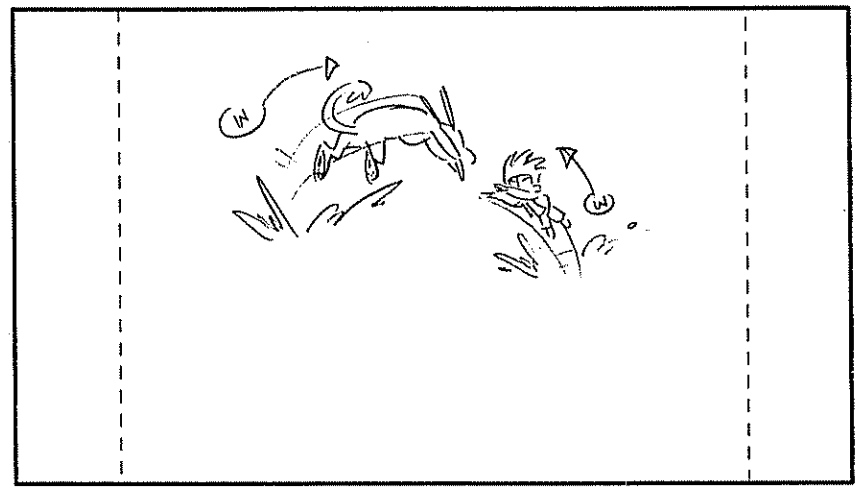

- AND LEAP INTO EACH OTHER'S VAT..

DIALOGUE

NOTES



22B



EPISODE: _____ PAGE: 129

SCENE 135 cont'd 5/6 BG

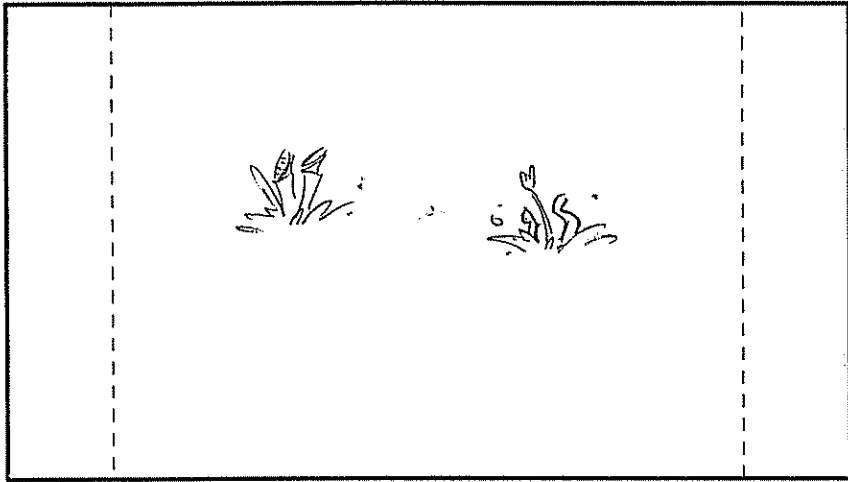

SCENE 4/6 BG

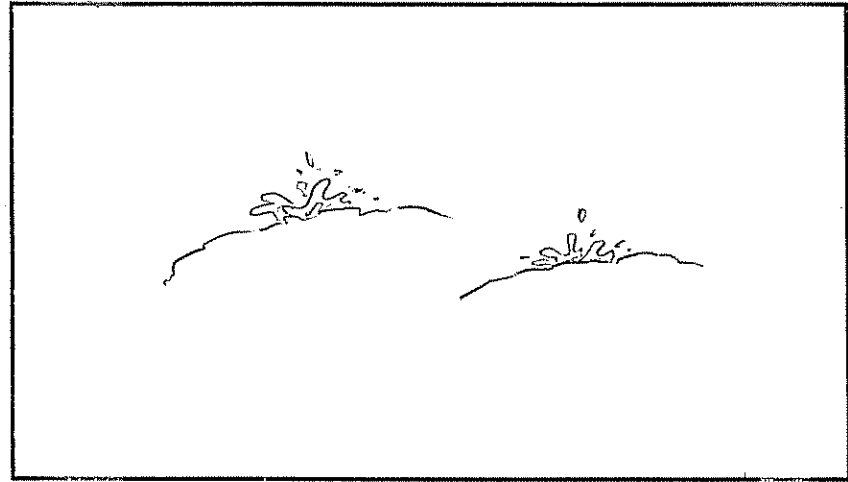

ACTION

DIALOGUE

NOTES



202B



EPISODE: _____

PAGE: 130

SCENE 136

BG

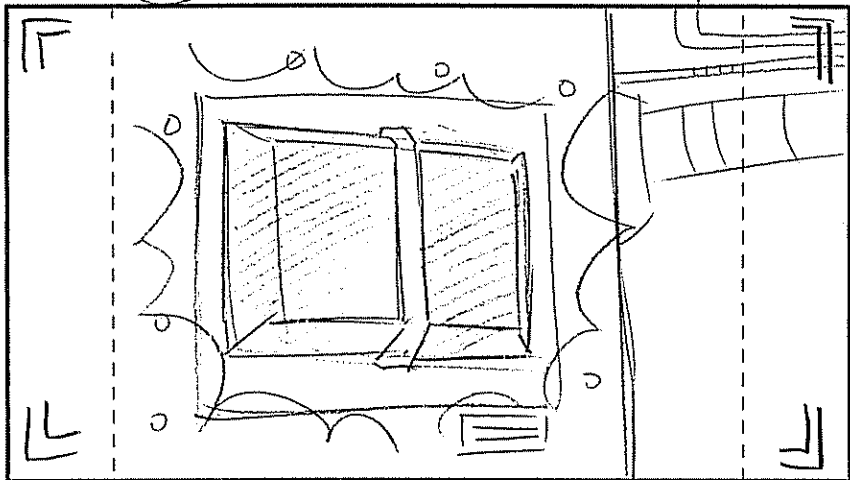

SCENE 137

GLASS TUBE LOWERS (H) BG

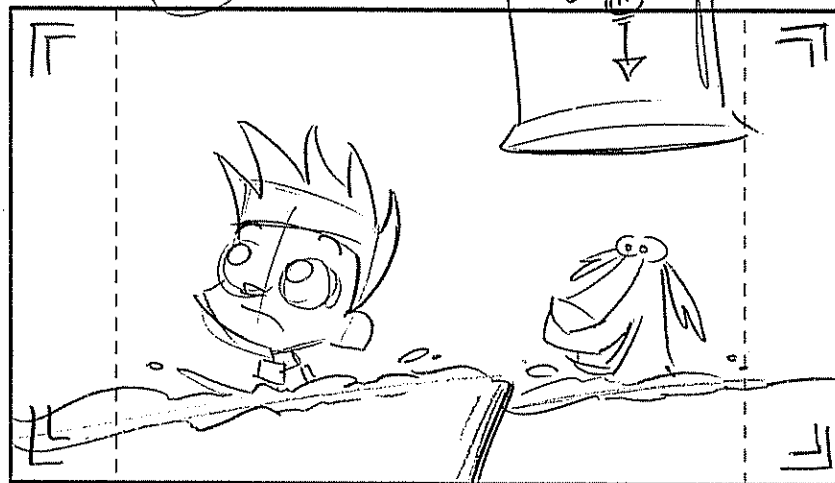

ACTION

CUT - NEARBY, - AN ALARM GOES OFF
- INTRO CAM. SHAKE

CUT - A GLASS TUBE LOWERS FROM THE CEILING..
- CONT. CAM. SHAKE!

DIALOGUE

Sfx:
(ALARM)

73. DUKEY
Cool, an ice cream quake.

NOTES



202B



EPISODE: _____

PAGE: 131

SCENE

127

CONT'D

2/3

BG



SCENE

3/3

BG

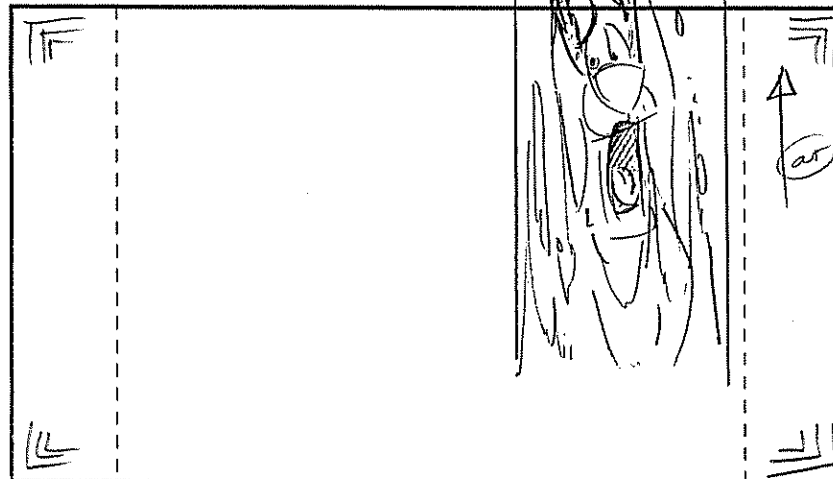

ACTION

- AND PULLS DUKEY (AND ICE CREAM) OUT OF FRAME -->

- CONT' COM. SHAKE!

DIALOGUE

74. DUKEY

Um, Johnny?

DO SOMETHING!!!

SFX: (Aeroplane) CONT'D

NOTES



202B



EPISODE: _____

PAGE: 132

SCENE (138)

BG

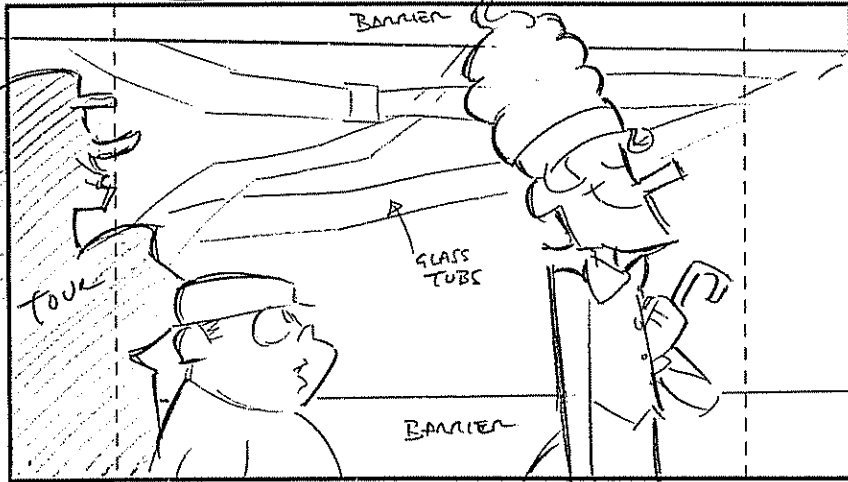

SCENE

BG

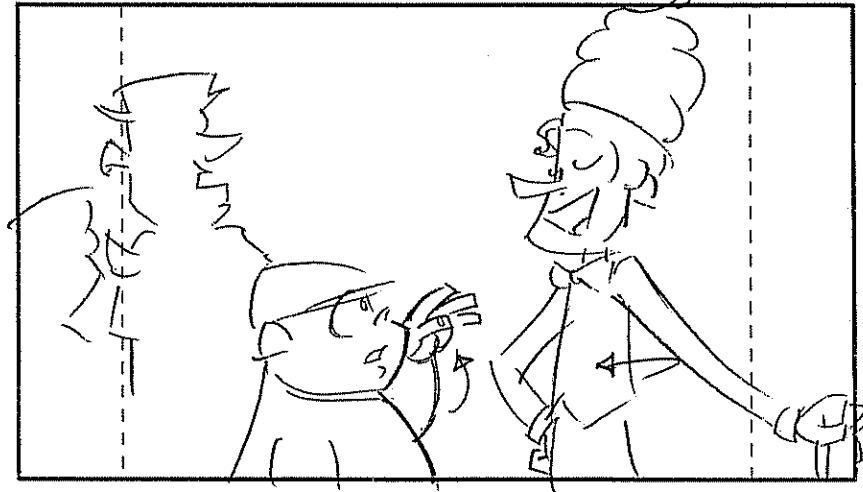

ACTION

- THE TOUR CONT.
- BEHIND THE GLASS IS A NUMBER OF GLASS TUBES.

- THE GUIDE TURNS AND THE TOUR STOPS.. CHUBBY KID TRYING 2 RAISE HIS HAND..

DIALOGUE

75. TOUR GUIDE
 Okay, any non-monkey questions

NOTES



202B



Re - VIS -
- ACTION

EPISODE: _____ | PAGE: 133

SCENE 138 CONT'D

3/3 BG

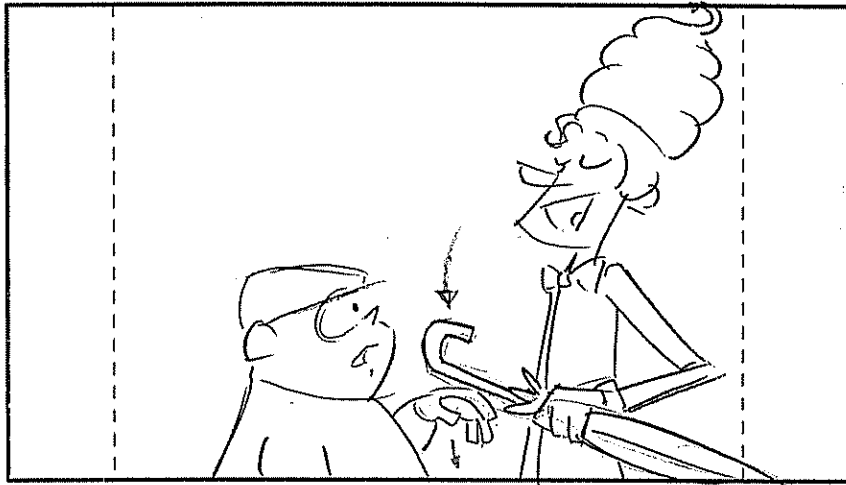

ACTION

* - THE GUIDE SLOWLY LOWERS
KID'S HAND

DIALOGUE

(75) TEAR GUIDE: (CONT'D)
before we proceed?

NOTES

SCENE (139)

1/2 BG

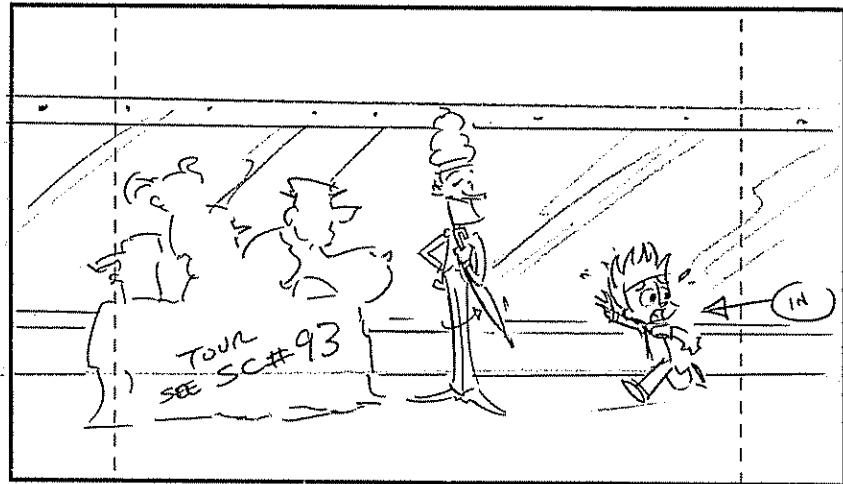

CUT WIDE: JOHNNY RACES INTO FRAME..

(76) JOHNNY:
Yes!



252B



(Re) - VIS -
- Dial.

SCENE 139 cont'd 2/2 BG

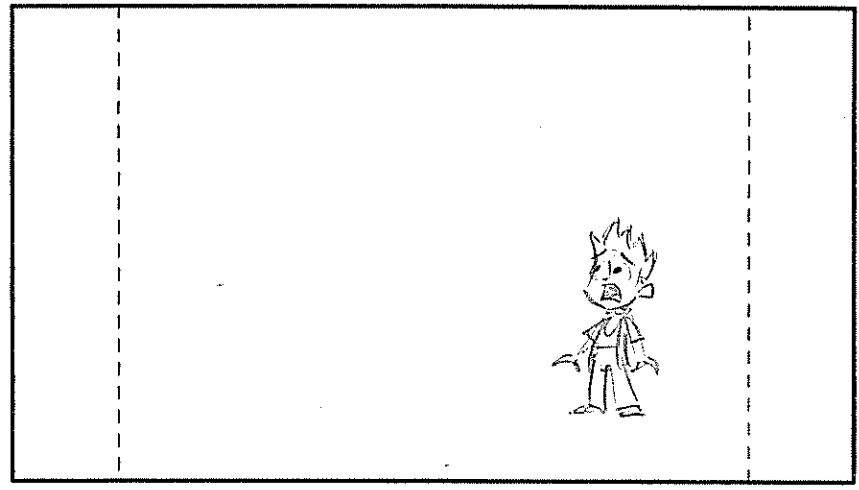

ACTION

DIALOGUE

76. JOHNNY : (cont'd)
UH, what would happen if someone
broke INTO THE PROCESSING PLANT AND...

NOTES



© 2006 Johnny Test Productions Inc "Johnny Test" TM Warner Bros Entertainment Inc

(A) - VIS
- Dial.

SCENE 139A PANEL 1/1 BG



(C) CLOSE UP Johnny

Johnny = (cont'd)

... FELL INTO A GIANT VAT OF ICE CREAM?



2020

EPISODE: _____ PAGE: 139A

Re-Direct

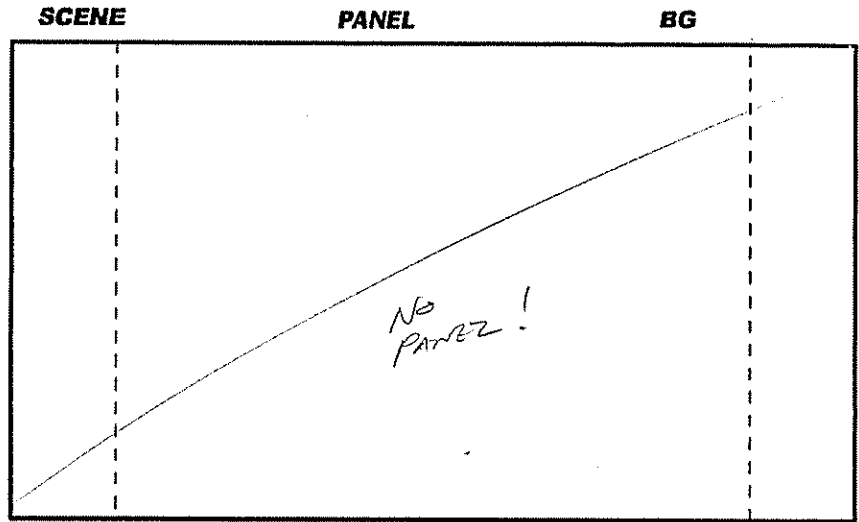

ACTION



WT TOUR GUIDE TURNS

DIALOGUE

77. TOUR GUIDE
 Well... they would go through the
 delightful process of being swirled INTO ICE CREAM...

NOTES

All Rights Reserved

collideoscope animation studios





R3 - PANEL #1's

2023

R2 - DIAL

EPISODE: _____

PAGE: 125

R2 - DIAL

SCENE (141)

1/3 BG



SCENE

2/3

BG



ACTION

- GUIDE CONT. DIA O/S ...

JOHNNY REACTS ...

- JOHNNY CONT ...

DIALOGUE

(77) TOUR GUIDE: (CONT'D O/S)
... chopped into 3
gallon rolls ...

(77) TOUR GUIDE: (CONT'D O/S)
... THEN sealed ...

NOTES



© 2006 Johnny Test Productions Inc. "Johnny Test" TM Warner Bros Entertainment Inc. All Rights Reserved

collidescope animation studios

(R3)-VIS.

SCENE 141 cont'd

PANEL

3/3

BG

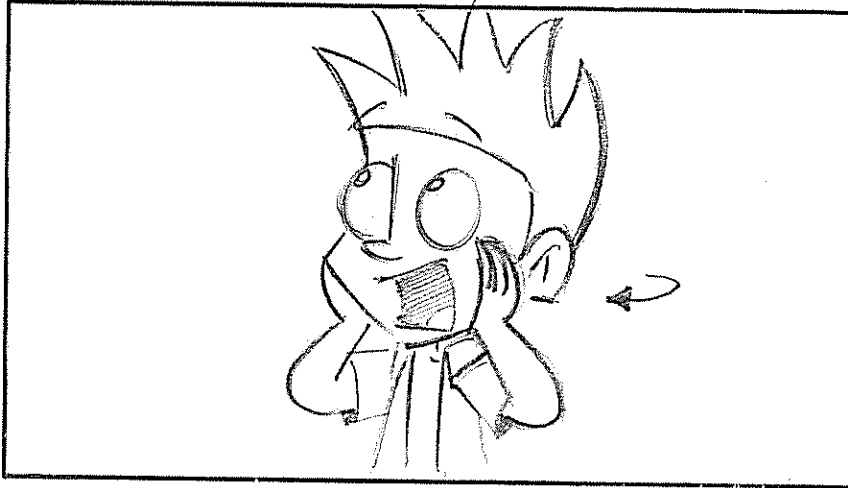

SCENE

PANEL

BG

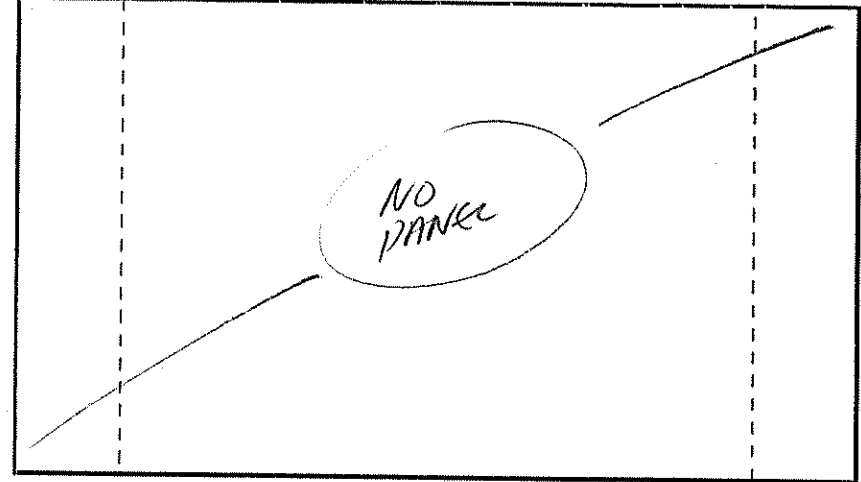

DIALOGUE

(77) TEAR GUIDE : (o/s cont'd)

... AND PACKED INTO OUR SUPER
COLD FREEZER...

NOTES

202B



(R2) PAGES (R3) -VIS.

EPISODE: _____

PAGE: 136

(R3) -VIS

SCENE (142)

1/7 BG

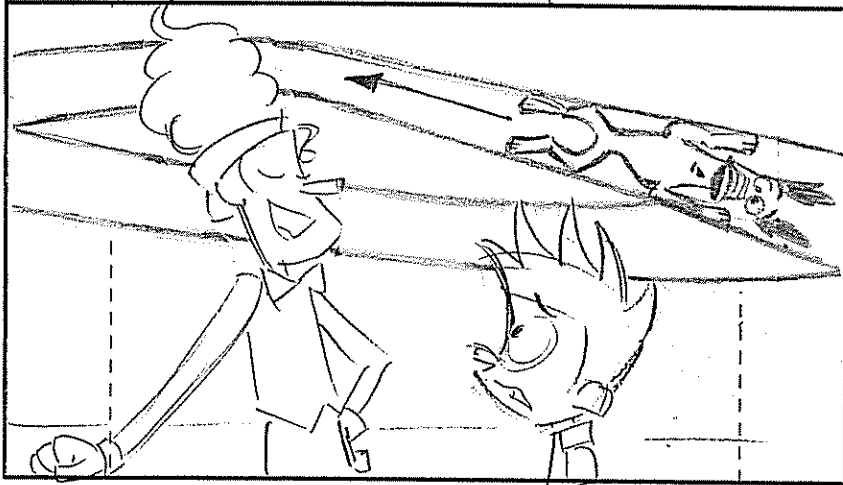

SCENE

2/7 BG



ACTION

cut

(77) TOUR GUIDE: (CONFID)

DIALOGUE

where life is unsustainable after our patented 3:00 minute final freezing process.

JOHNNY TURNS AND RUNS (OUT) SCREAMING..

Johnny: (HOR)
NEEYAH!

NOTES



© 2006 Johnny Test Productions Inc. "Johnny Test" TM Warner Bros Entertainment Inc All Rights Reserved

collidescope animation studios

(23) - NEW VIS.

SCENE 142 CONT'D PANEL 3/7 BG

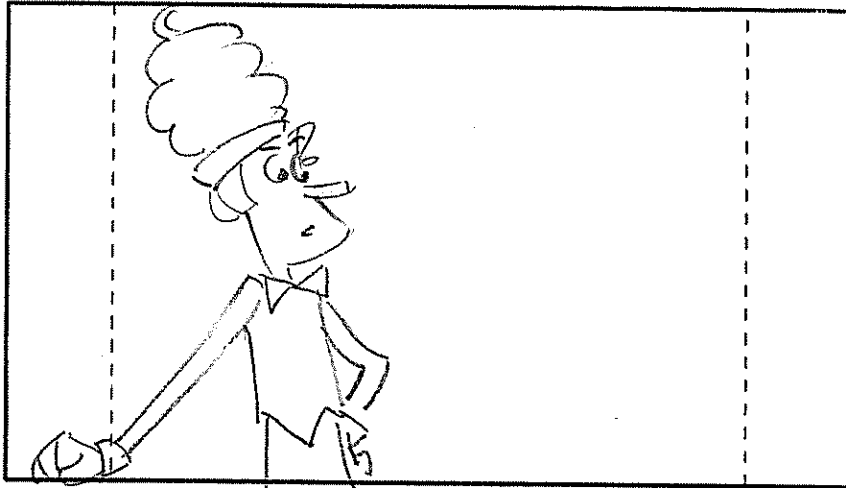

ACTION

SCENE PANEL BG

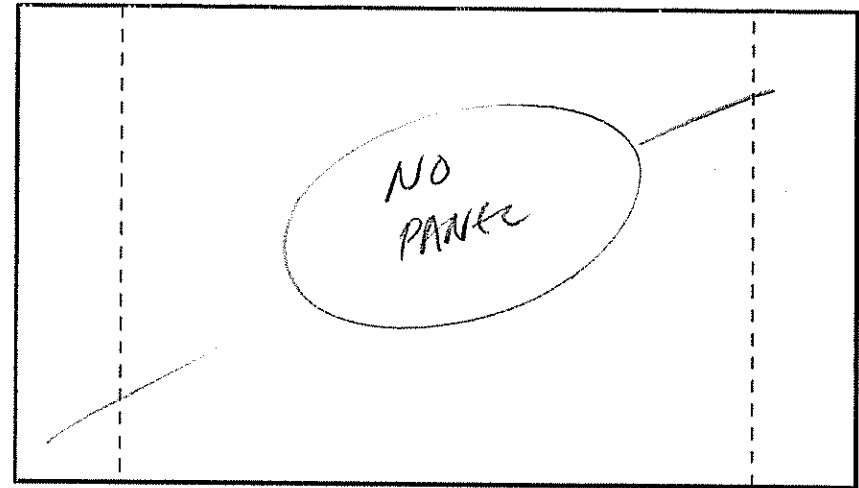

DIALOGUE

NOTES

202B



(RS) - PANKA#
- VIS.

SCENE 142 CONT'D

4/7 BG

SCENE

BG

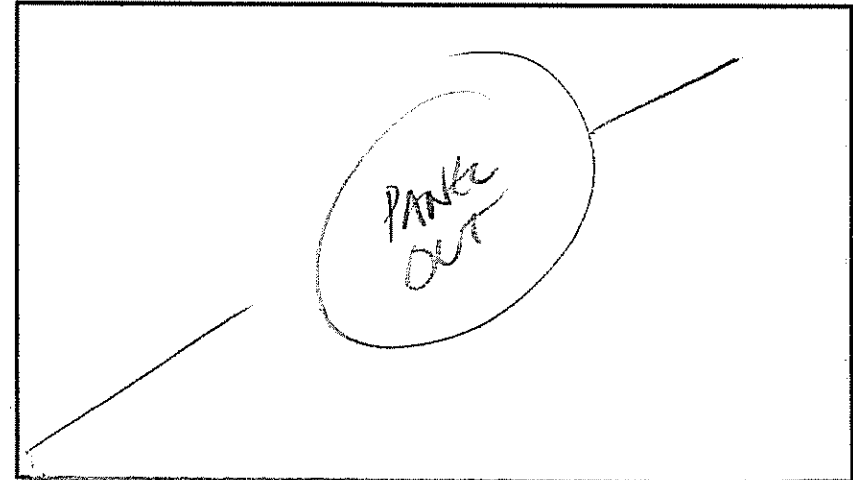
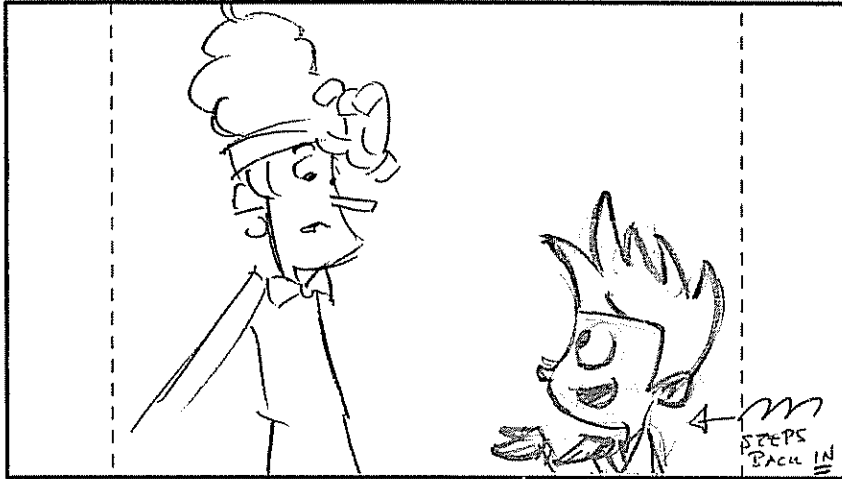

ACTION

(BEAT) JOHNNY SLOWLY RETURNS..

DIALOGUE

(78) Johnny

How MUCH...

LONGER 'TIL THE FREE SAMPLES?

NOTES



(RS)

202B

* No Pg. 138!



(R2) - US.
- ACTION.
- DIAL

(R2) - US.

EPISODE: _____ | PAGE: 138A

SCENE 142 CONT'D 5/7 BG

SCENE 6/7 BG

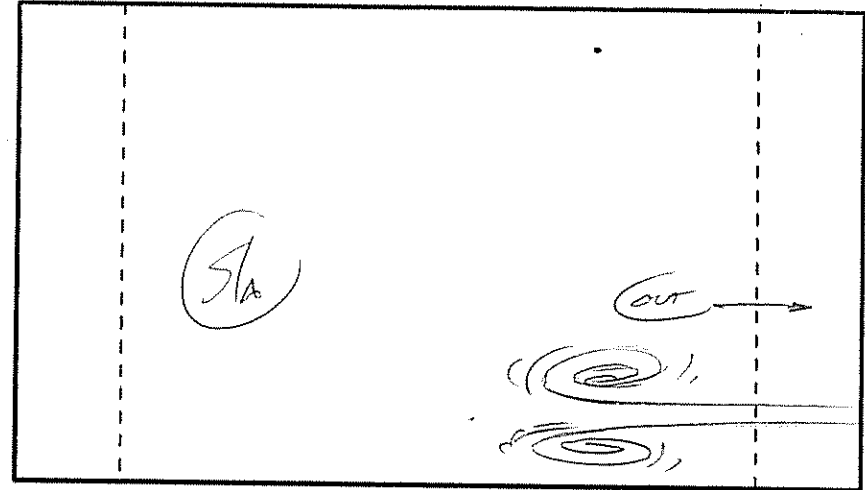
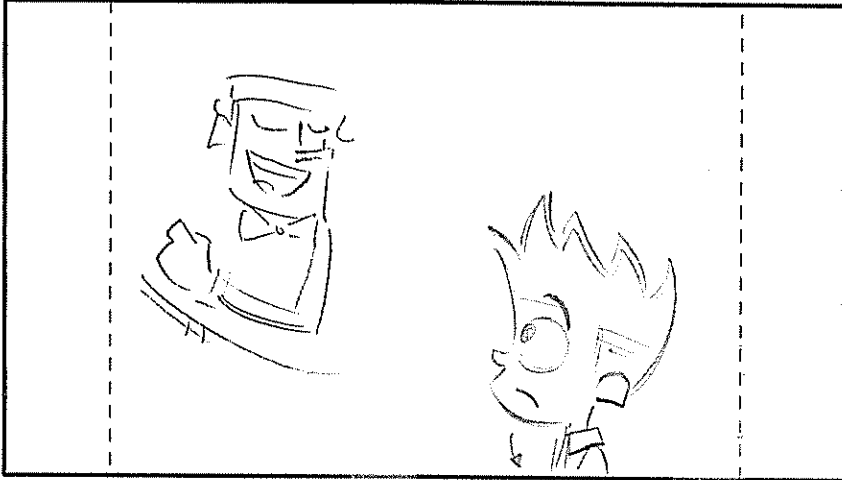

ACTION

ACTION

Johnny zips off

DIALOGUE (79) TOUR GUIDE:
"ANOTHER HALF HOUR."

NOTES



© 2006 Johnny Test Productions Inc. "Johnny Test" TM Warner Bros. Entertainment Inc. All Rights Reserved

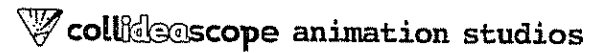

RS-VIS.

SCENE 142 CARD PANEL

7/4

BG

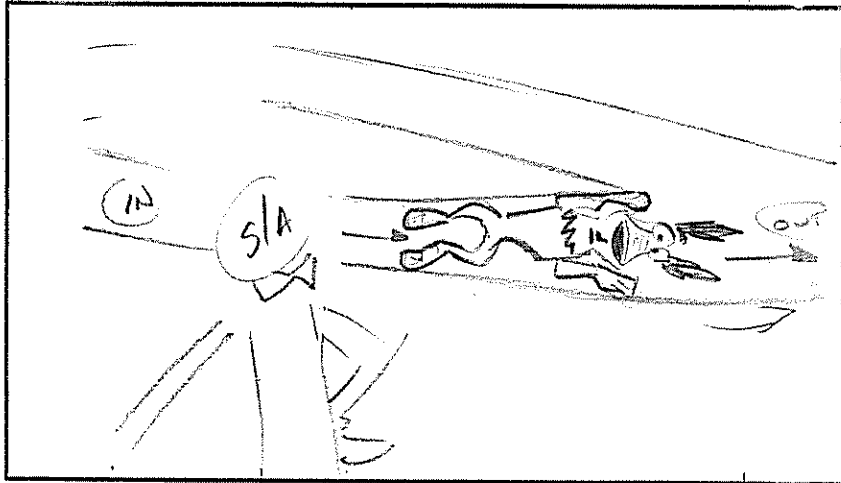

OUT

SCENE

PANEL

BG

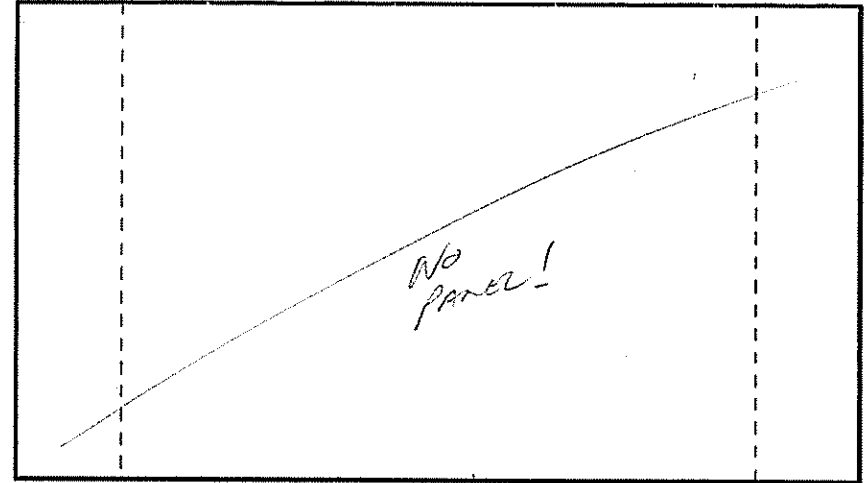

- BEHIND THE CURTAIN, DUKEY (AND SOME ICE CREAM) IS LAUNCHED THRU A TUBE

DIALOGUE

~~DUCKY~~ = (AOR/LIB)
(MUFFLED SCREAM)

NOTES

Re - VIS.

SCENE

143

PANEL

1/4

BG

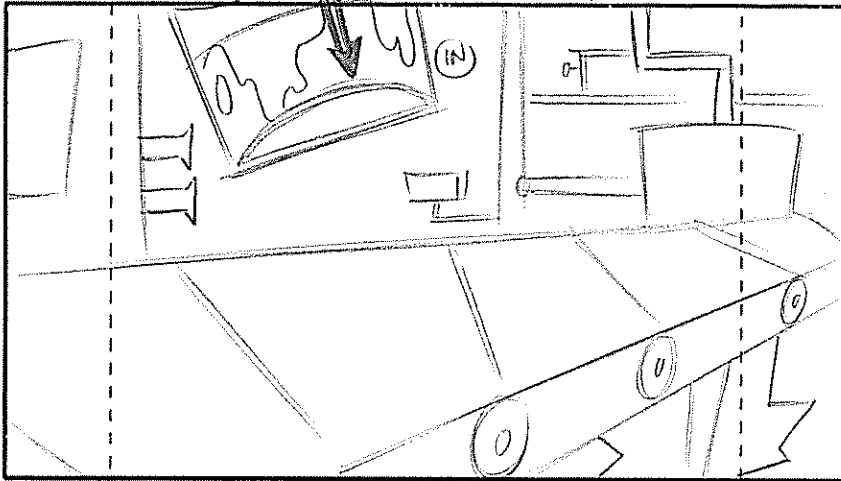

SCENE

PANEL

2/4

BG

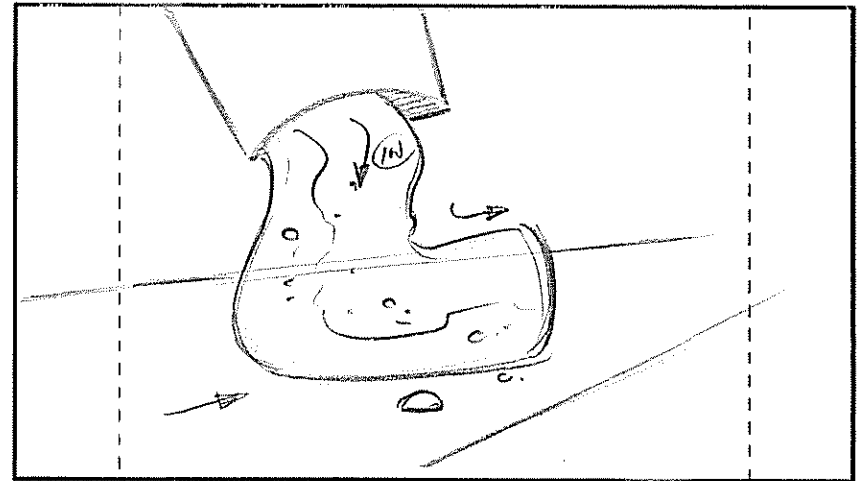

ACTION

ELSEWHERE IN FACTORY

CUT

TUBE IN ABOVE CONVEYOR BELT

→ POURS ICE CREAM!

DIALOGUE

NOTES

RE - US.

RE - VEE.

SCENE 1B CONFID PANEL

3/4

BG

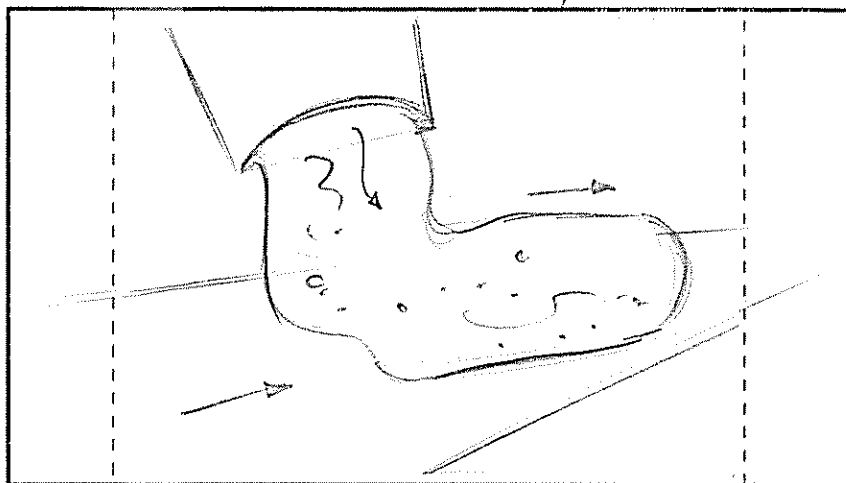

ACTION

SCENE

PANEL

4/4

BG

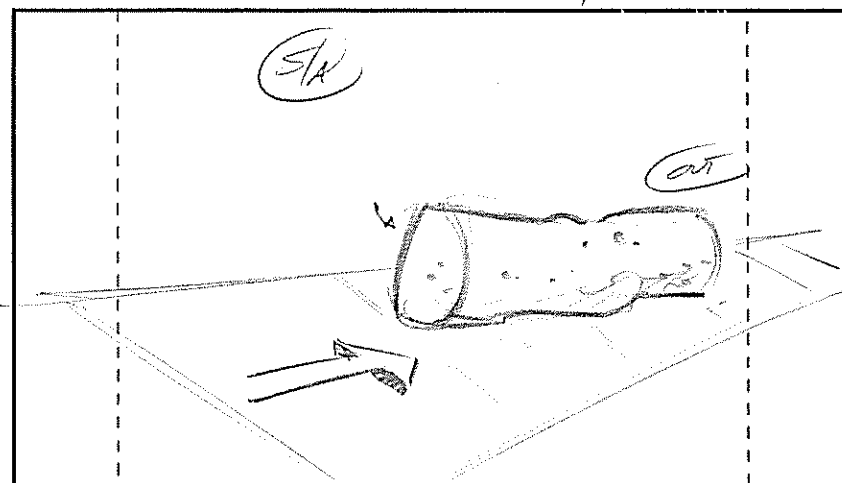

ICE CREAM MOVES OUT ON BELT.

DIALOGUE

NOTES

R2 VIS.

R2 - VIS.

SCENE 144

PANEL

1/4

BG

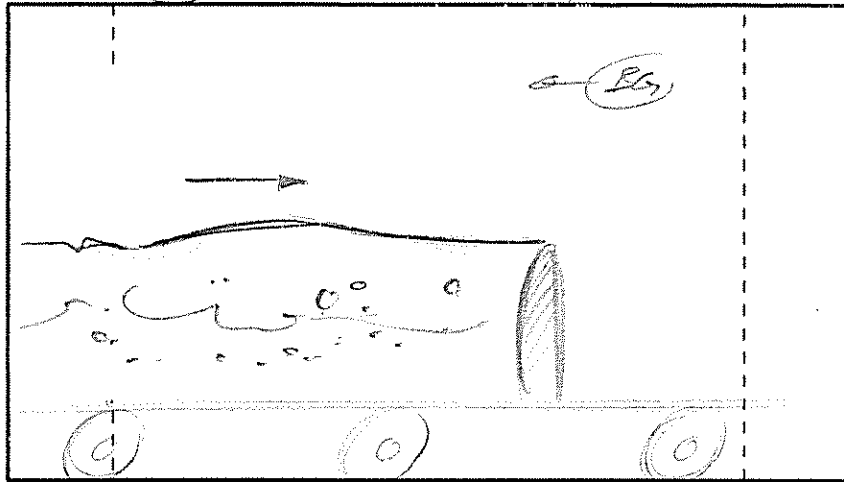

SCENE

PANEL

2/4

BG

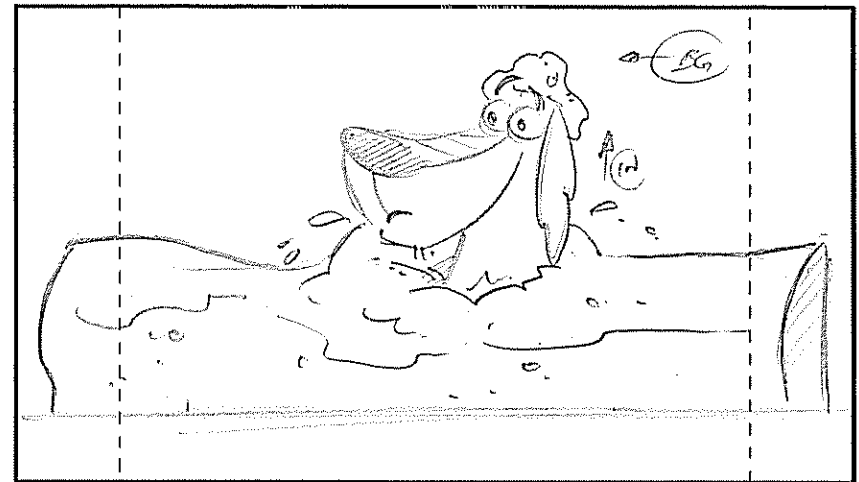

ACTION

TO ICE CREAM MOUND GRABS TO ϕ .
 (PANS BG ET)

- DUCK IN FROM ICE CREAM.

DIALOGUE

NOTES

(P2) - VS -

(P2) - VS -

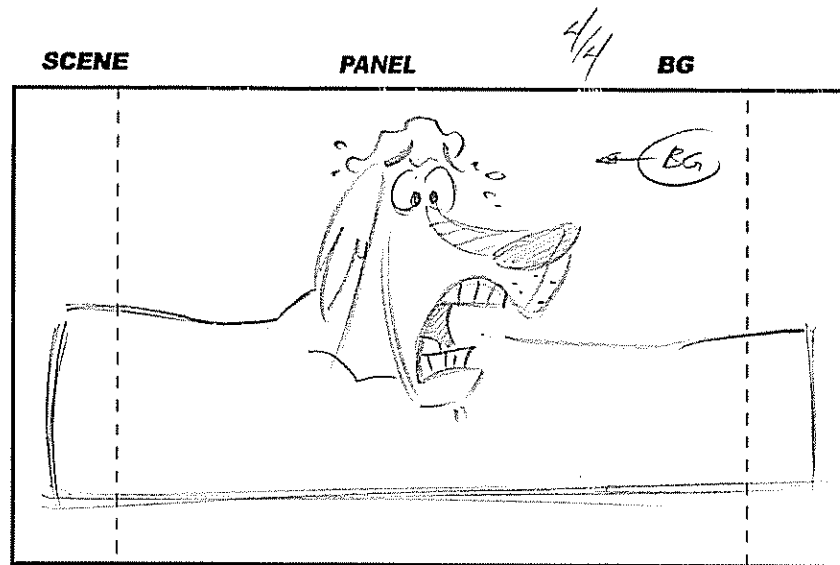
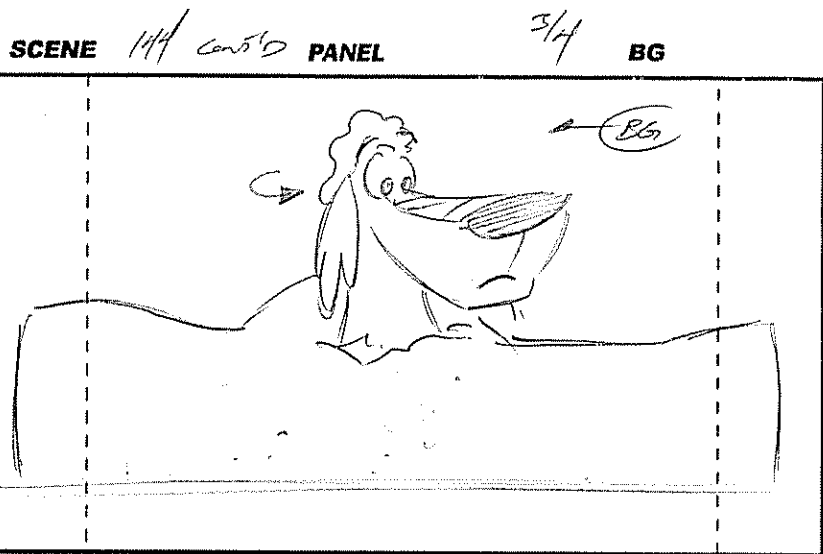

ACTION

Dukeof turns to look of S TEST!
 (BG Panel 114 CONF'D)

Dukeof REACTS!

DIALOGUE

(SO) Dukeof:
 AHHA!!! CHEERS!

NOTES

2023



SCENE 145

1/2 BG

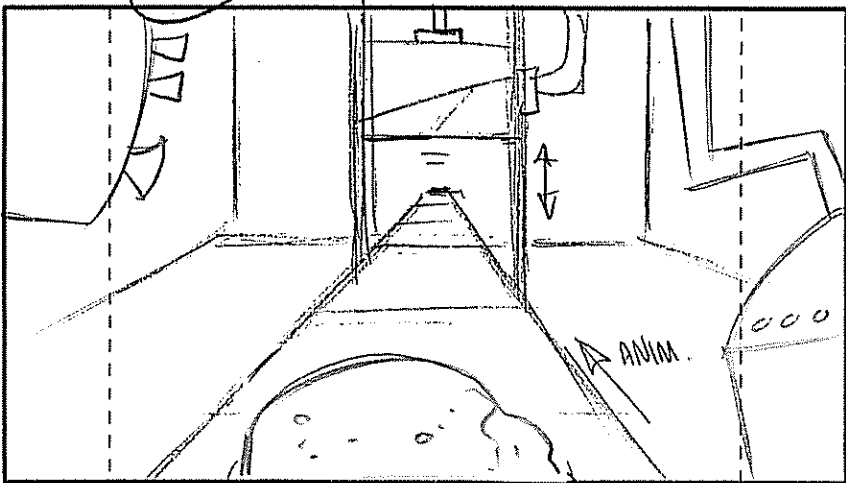

SCENE

2/2 BG

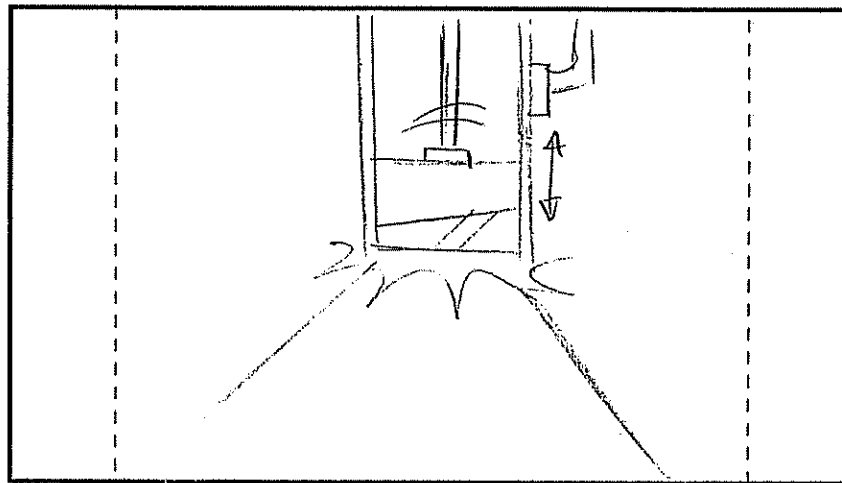

ACTION

(cut) SLOW TRUCK IN ON ALL ELEMENTS EXCEPT FG ICE CREAM

BI BACK

BLADE DEERS!

DIALOGUE

(80) Duff: (conf d/s)
BIG, BIG CHOPPERS!

NOTES



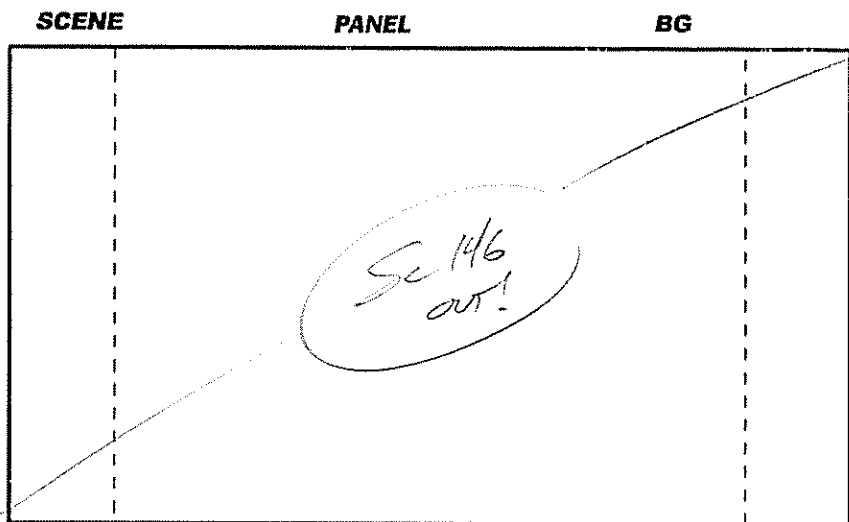

ACTION

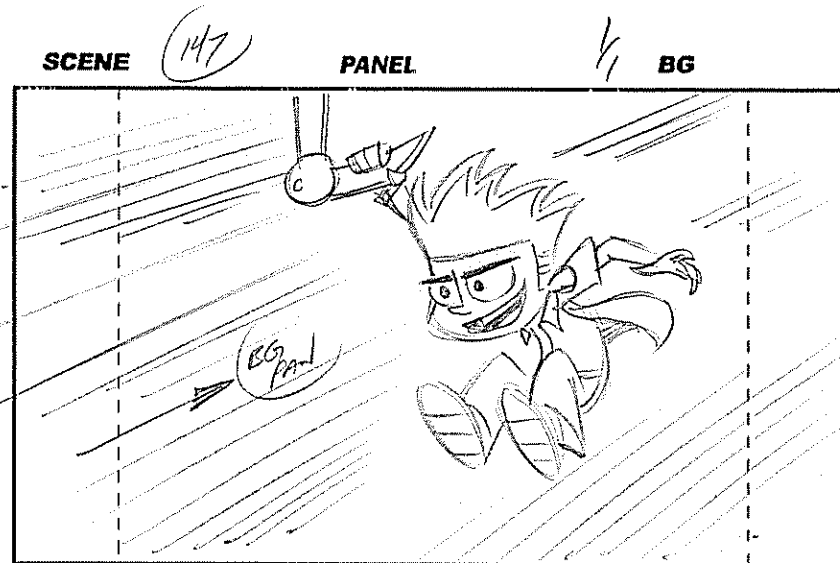

- To Johnny hanging from a
 MECHANICAL ARM. (Hold on Johnny)
 - DIAG. Panel ZIP EG! (X)

(cut)

DIALOGUE

(81) Johnny:
 Don't worry! I got you!

NOTES

RE-DIAL

SCENE 148

1/2 BG

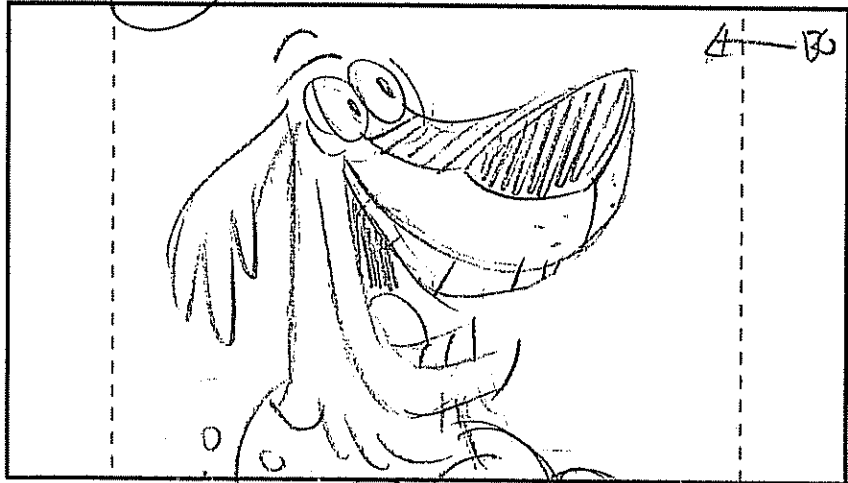

SCENE

2/2 BG

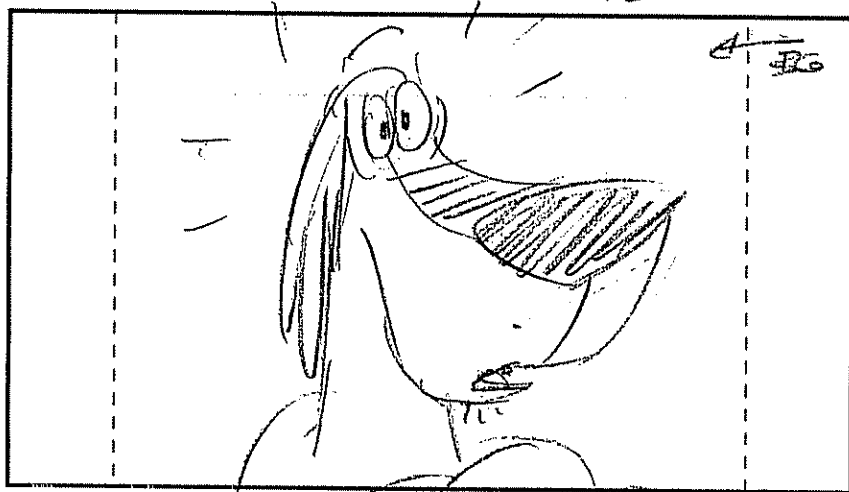

ACTION

(CUT)

Close on Ducky
(Pan BG LT)

Ducky reacts

DIALOGUE

SFX (O.S.): (CLAMP)!

NOTES





RE - SC #

202B

RE PAGE #

EPISODE: _____

PAGE: 141B

SCENE 148A

1/2 BG

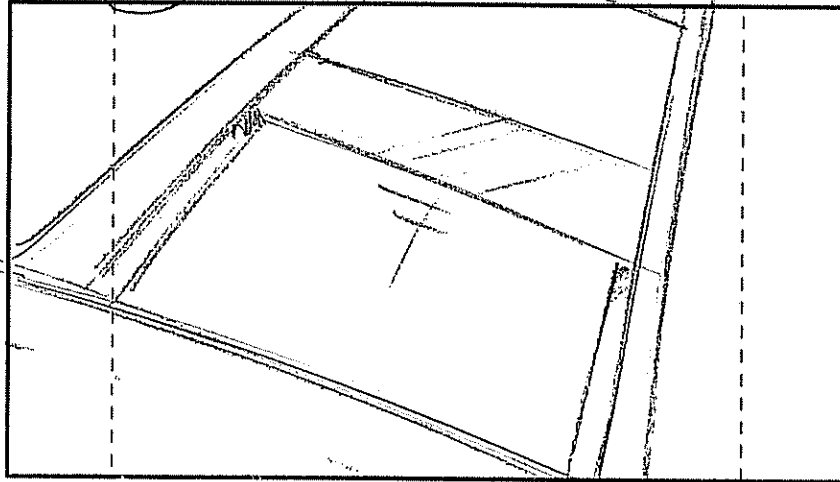

SCENE

2/2BG

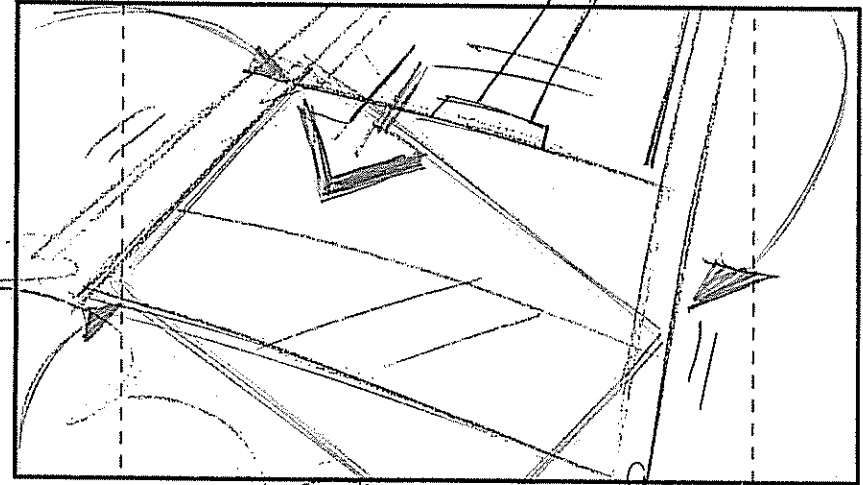

ACTION

CS CLOSE ON CHOPPER

CYCLE CHOPPER

BLADE DROPS!

TWIST TRUCK IN

DIALOGUE

SFX:
(CHOP!!!)

NOTES



© 2008 Johnny Test Productions Inc. "Johnny Test" TM Warner Bros. Entertainment Inc. All Rights Reserved

collidescope animation studios



202B

(R2) - Per #

EPISODE: _____ | PAGE: 141C

(R2) - SC #
- VS -

(R2) - VS.

SCENE 148B

1/2 BG

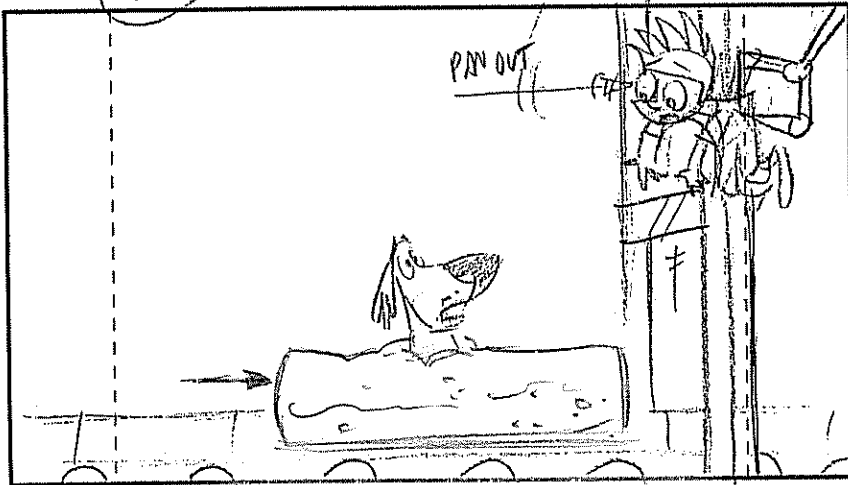

SCENE

2/2 BG

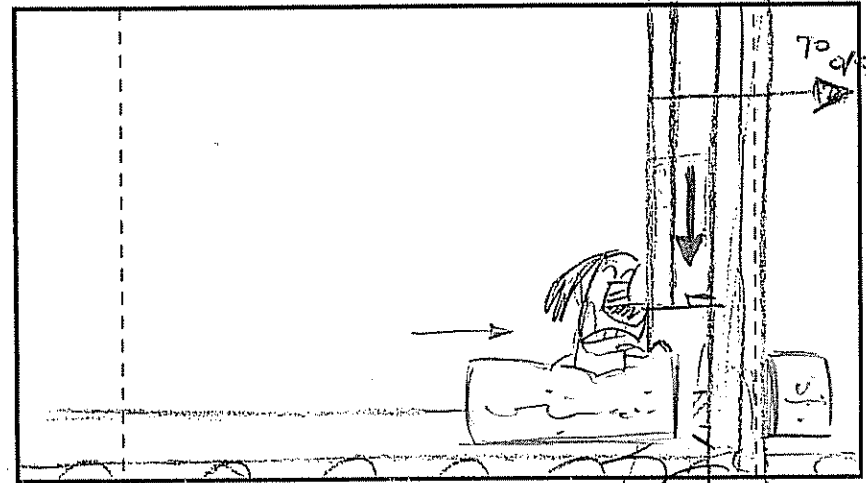

ACTION - Johnny PANE OUT (RT) WITH CLAMP
(CUT) - Duke MOVES CLOSER TO CHOPPER

- BLADE FALLS IN FRONT OF WINCING DUKE!

DIALOGUE

SFX:
(CHOP!)

NOTES



© 2008 Johnny Test Productions Inc. "Johnny Test" TM Warner Bros. Entertainment Inc. All Rights Reserved

collidescope animation studios

202B

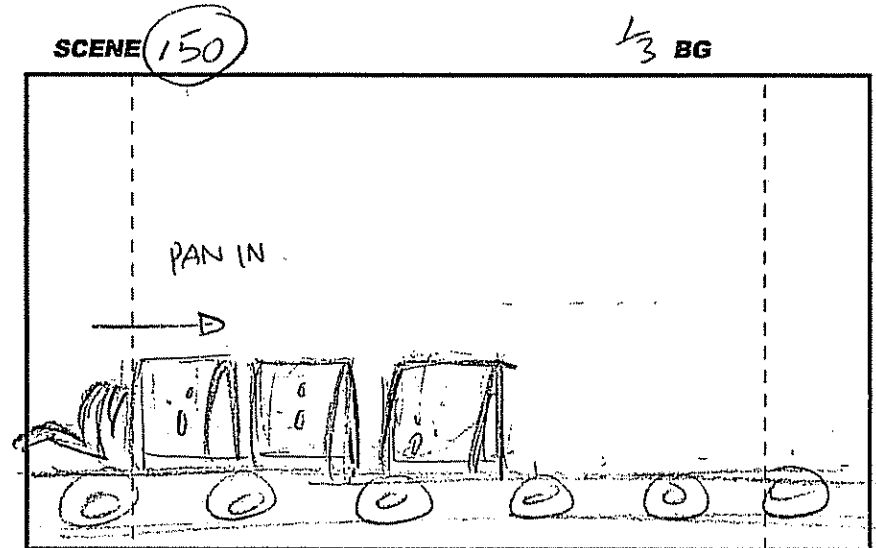
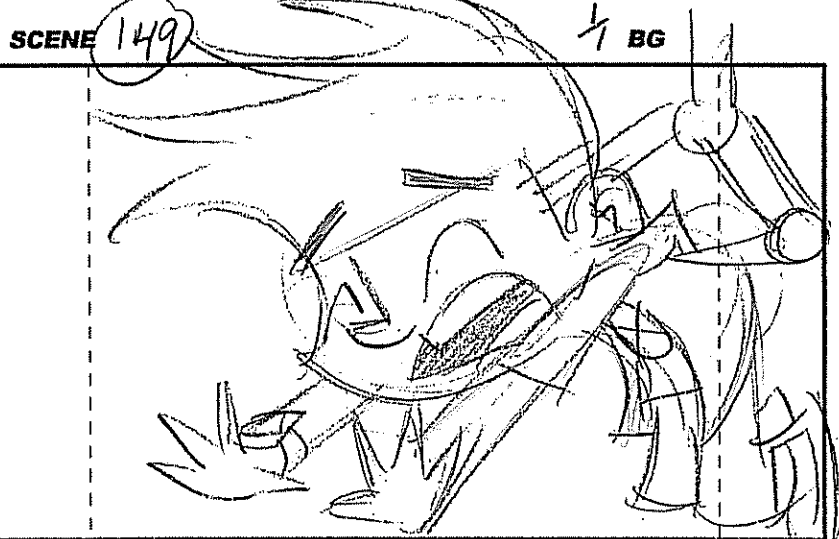

ACTION

(cut) Close of Johnny screaming!

(cut) SLICES OF ICE CREAM PAN IN

DIALOGUE

(82) JOHNNY :
NOOO!!!

NOTES



202B



SCENE 150 CONT

2/3 BG

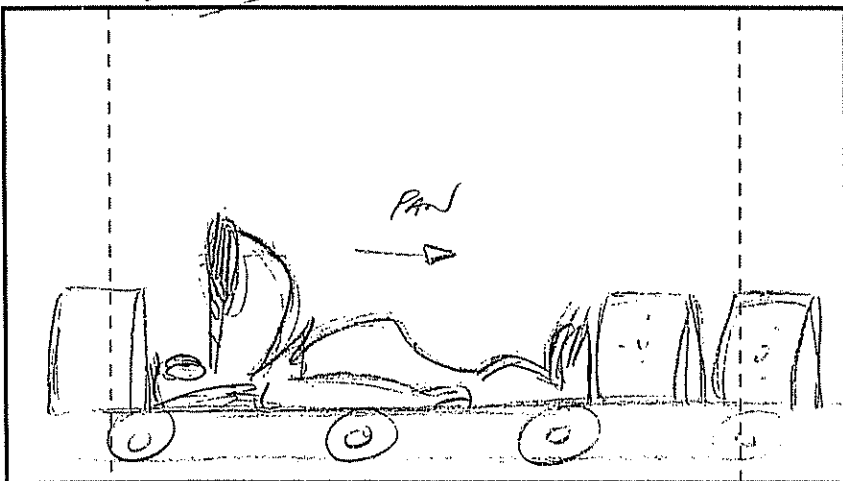

ACTION

- Followed by Ducef
(PAN CONT'D) →

SCENE

3/3 BG

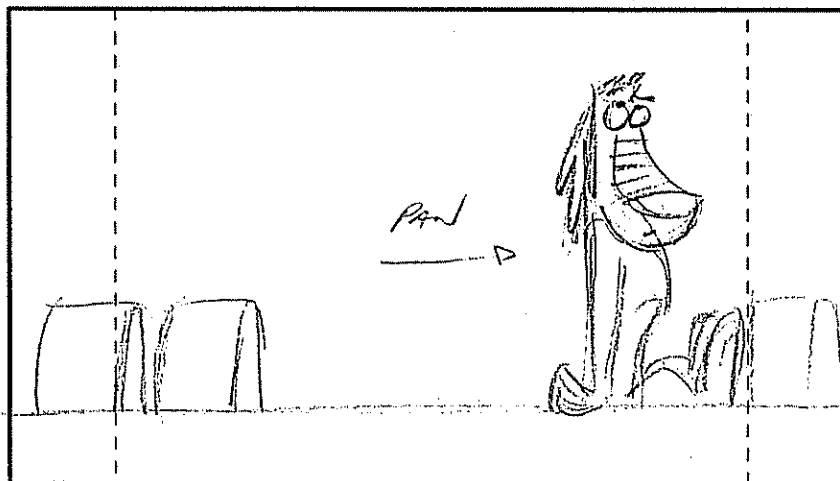

- Ducef STS UP &
LOOKS AT TOP OF HIS
HEAD! (PAN CONT'D) →

DIALOGUE

NOTES



SCENE (131)

1/2 BG

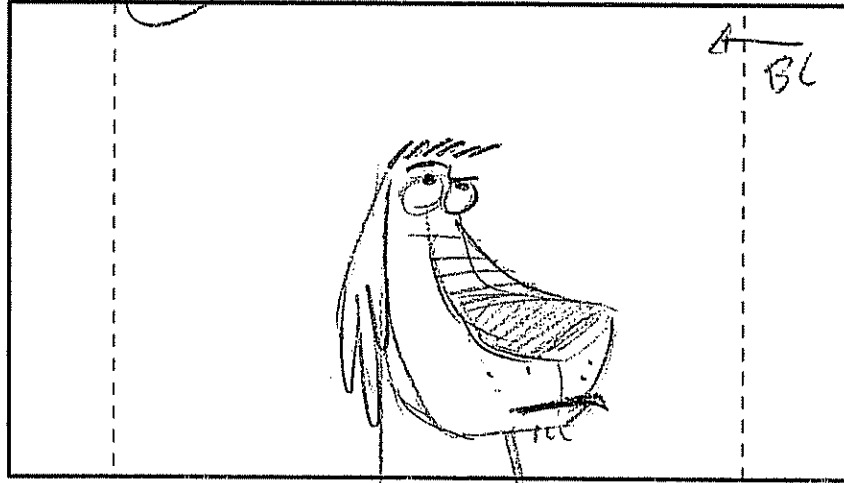

SCENE

2/2 BG

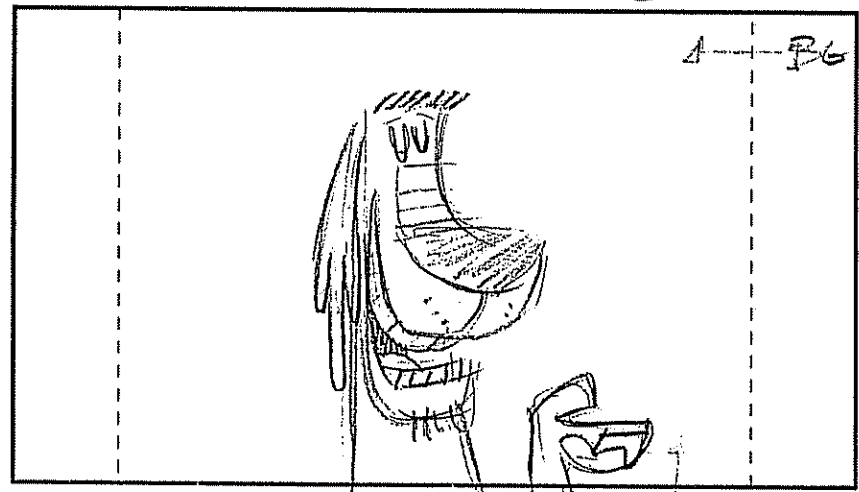

ACTION

CUT

CLOSE ON DUKEY
(PAN BA LT)

DIALOGUE

(23) DUKEY =
HMMM...

COULD HAVE USED A LITTLE MORE OFF THE TOP...

NOTES



202B

(RZ) NE PGS 144, 145!



EPISODE: _____

PAGE: 146

(RZ) SC 152-155
OUT!

156
SCENE

(RZ) - Panels

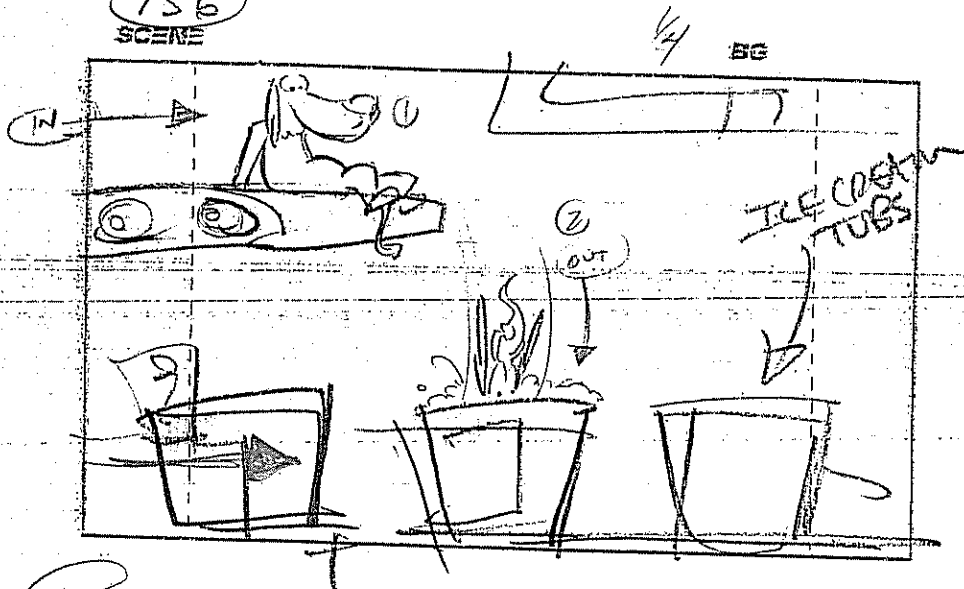

(W)

WIDE: DUNCAN IS DROPPED
INTO AN ICE CREAM TUB
(UPON ANOTHER BELT BELOW)

DUNCAN: (ADR)

AAAAHH!!!

ALWAYS SPEAK

DIALOGUE

NOTES



Inc. All Rights Reserved

collidoscope animation studios

202B

JOHNNY TEST
(13) - Panels

EPISODE: _____

PAGE: 147

(13) - New Panels

SCENE 156 CONT'D

2/4 BG

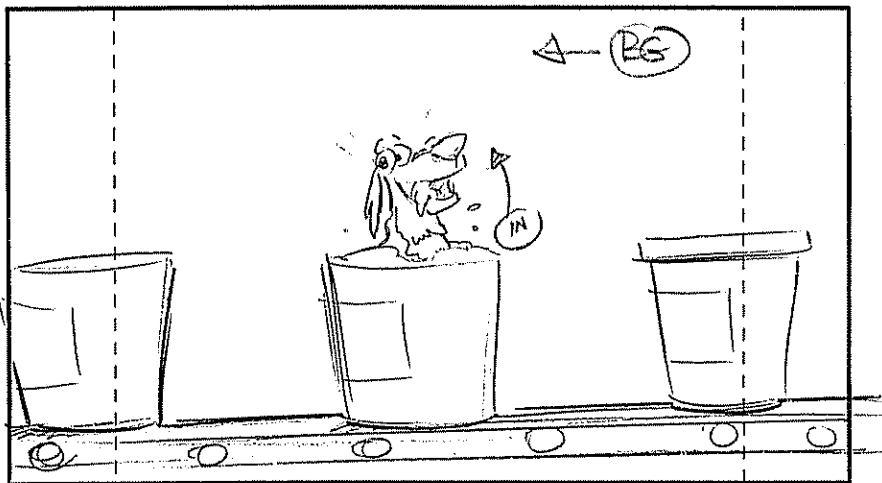

SCENE

3/4 BG

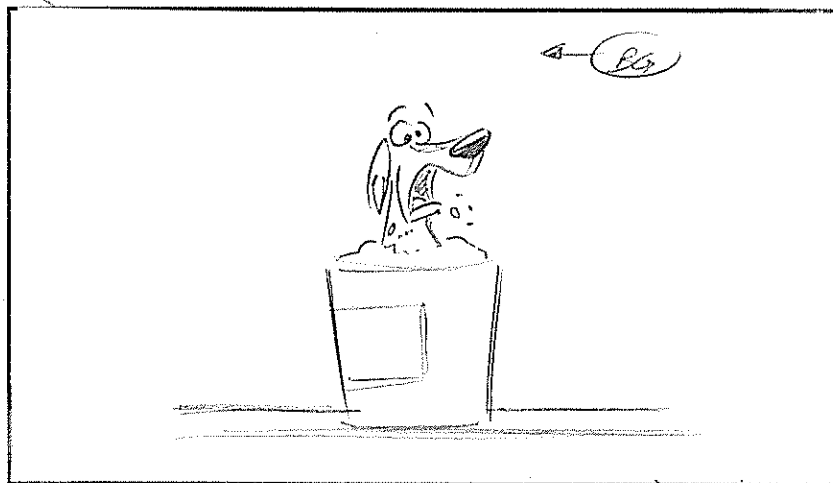

ACTION

- DUKEY POPS OUT OF THE TUB -

DIALOGUE

Duke: (HOR)
TASTY, BUT...

... AAHHHH!!!

NOTES



© 2006 Johnny Test Productions Inc "Johnny Test" TM Warner Bros Entertainment Inc All Rights Reserved

collidescope animation studios

(R3) - Panel #

SCENE 156

cont'd 4/4

BG

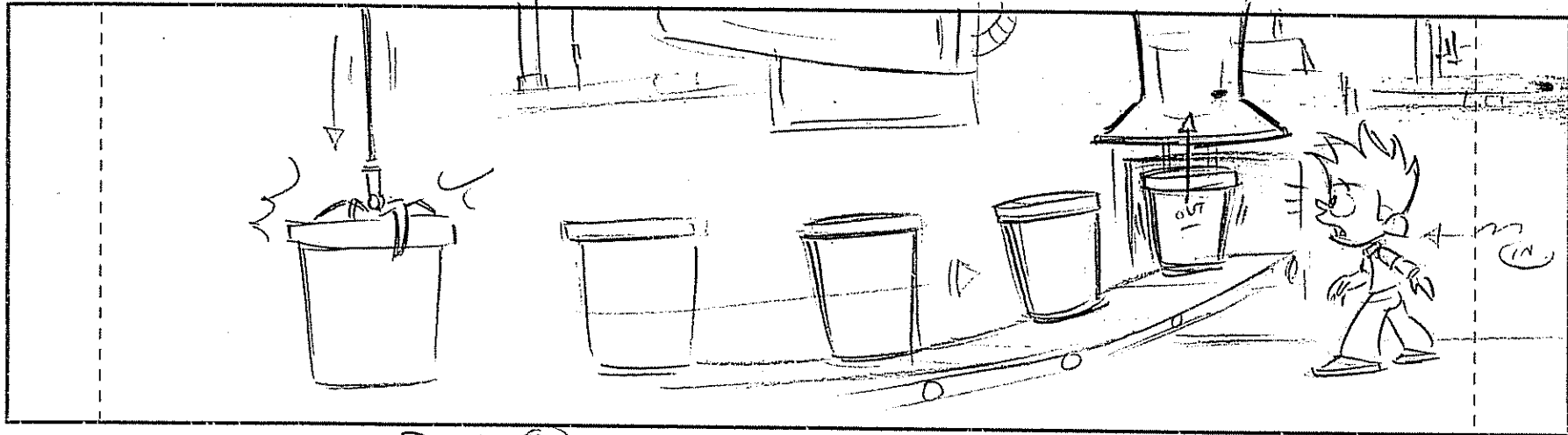

ACTION

DAN (A) —————> (B)

- A LID CLOSES DOWN UPON DUKEY -

HIS AND MANY OTHER TUBS ARE BEING PULLED INTO A VACUM LIKE PIPE. - JOHNNY APPROACHES

DIALOGUE

NOTES

RC - VIS
- ACTION

SCENE 157

1/2 BG

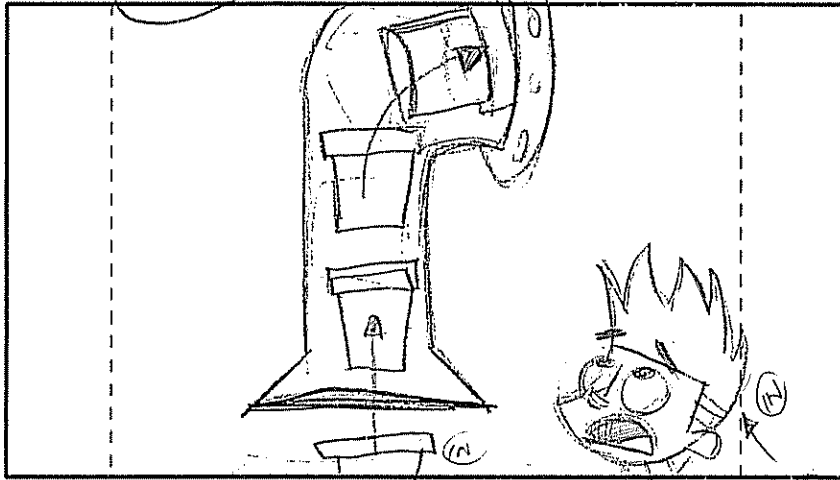

ACTION

CUT TO Johnny POPS IN WATCHING TUB GETTING SUCKED UP INTO PIPE

SCENE

2/2 BG

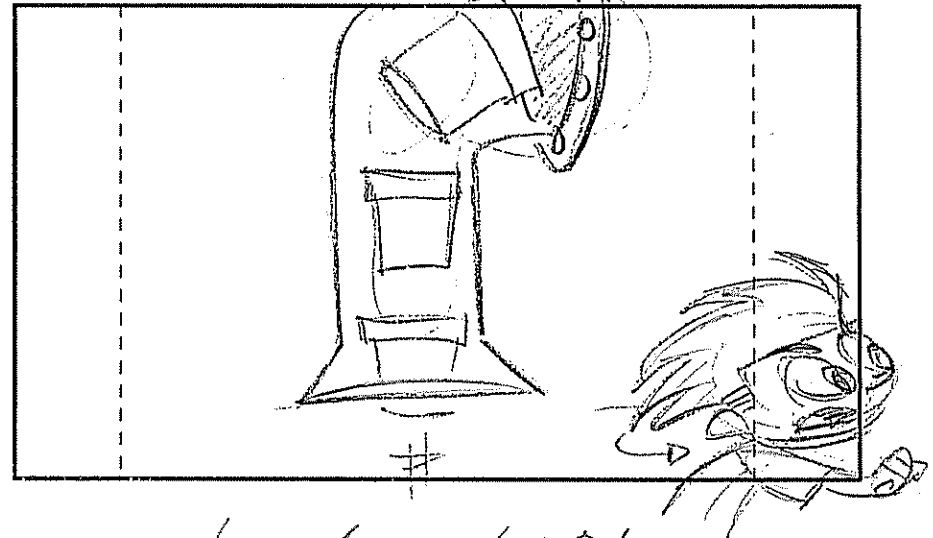

Johnny runs ds RT!

DIALOGUE

NOTES



202B



SCENE 158

1/4 BG

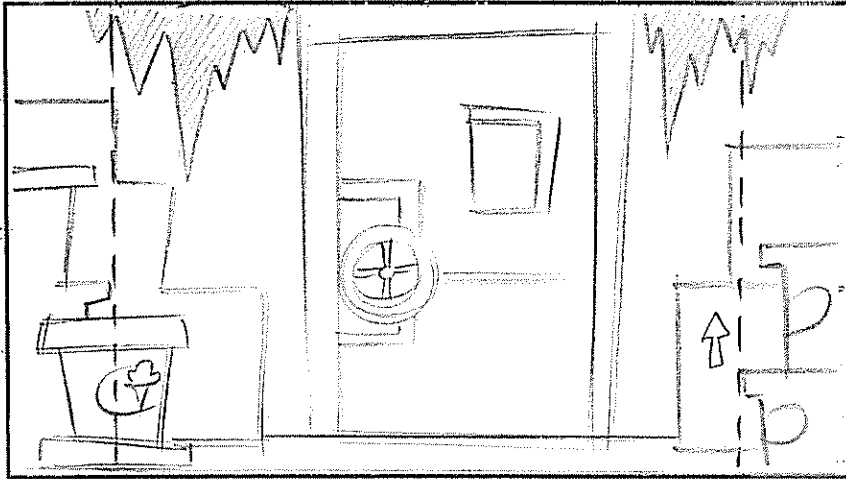

SCENE

2/4 BG

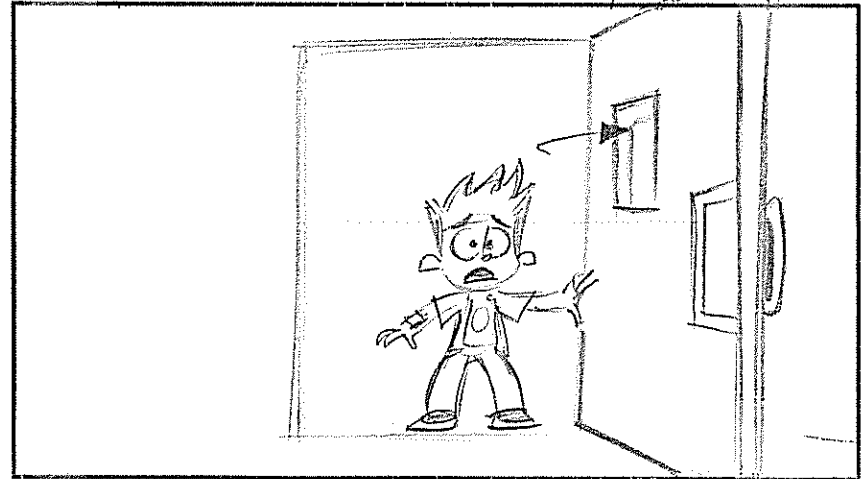

ACTION

INT. FREEZER.

CUT

Johnny opens Door!

DIALOGUE

NOTES



2023



SCENE 158 CONT

3/4 BG

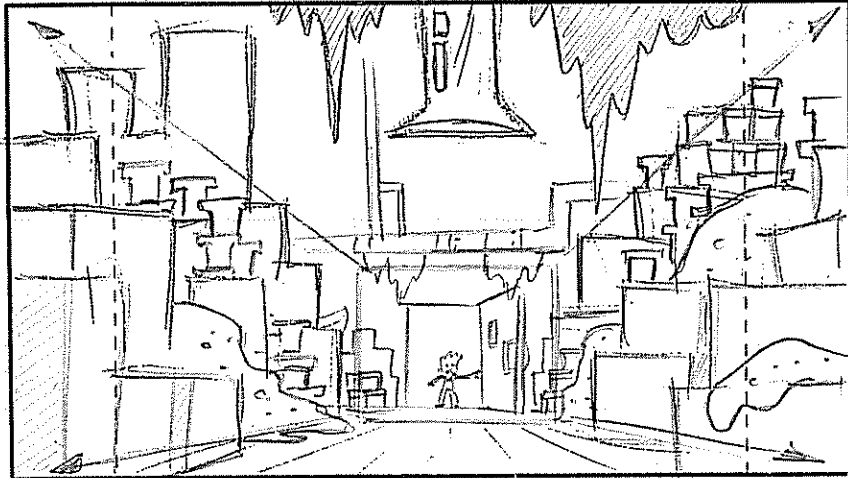

SCENE

4/4 BG

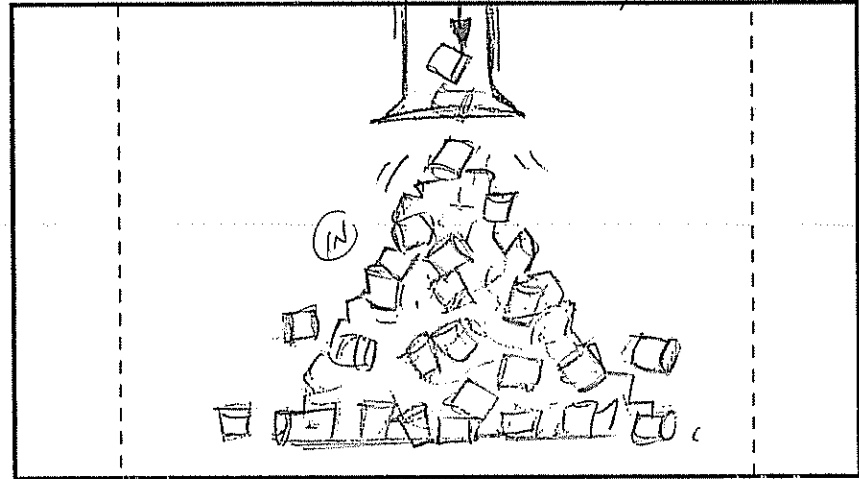

ACTION

QUICK TELL-OUT UNDER!

TENS OF ICE CREAM TUBS FALL OUT OF PIPE!

DIALOGUE

NOTES



202B



EPISODE: _____ | PAGE: 150

SCENE 158A

1/4 BG

SCENE

BG

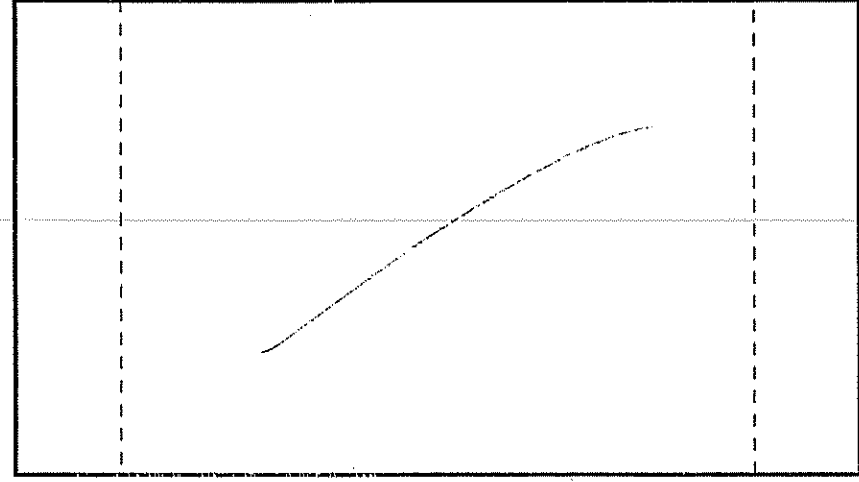
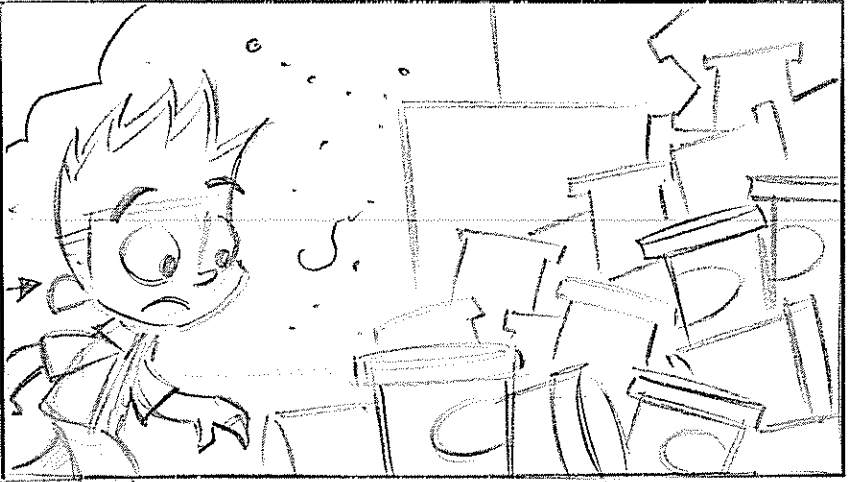

ACTION

Johnny WALKS IN

DIALOGUE

NOTES



© 2006 Johnny Test Productions Inc. "Johnny Test" TM Warner Bros. Entertainment Inc. All Rights Reserved.

collidea scope animation studios

202B

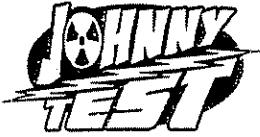

EPISODE: _____

PAGE: 151

SCENE 158A

CONT'D

2/4

BG



SCENE

3/4

BG



ACTION

- HE RAISES IT -

Johnny PICKS UP TUB.

DIALOGUE

(85) Johnny:
Don't worry, Denny...

Johnny: (KOP)
I'll find you. I hope.

NOTES



© 2006 Johnny Test Productions Inc. "Johnny Test" TM Warner Bros Entertainment Inc. All Rights Reserved

collideascope animation studios

202B



SCENE 158A CNT

4/4 BG



SCENE 159

1/1 BG

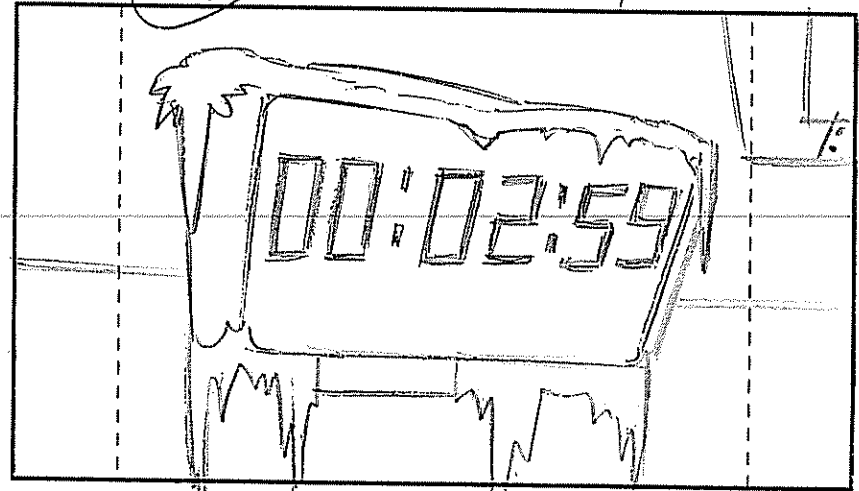

ACTION

Johnny REACTS TO O/S LT.

(CUT) TO DIGITAL TIMER COUNTING DOWN.

DIALOGUE

(S6) COMPUTER VOICE = (O/S)
FINAL FREEZING PROCESS COMPLETE
IN

(S6) COMPUTER VOICE = (O/S CONT'D)
... THREE MINUTES.

NOTES



SCENE 160

PANEL 1/3

BG

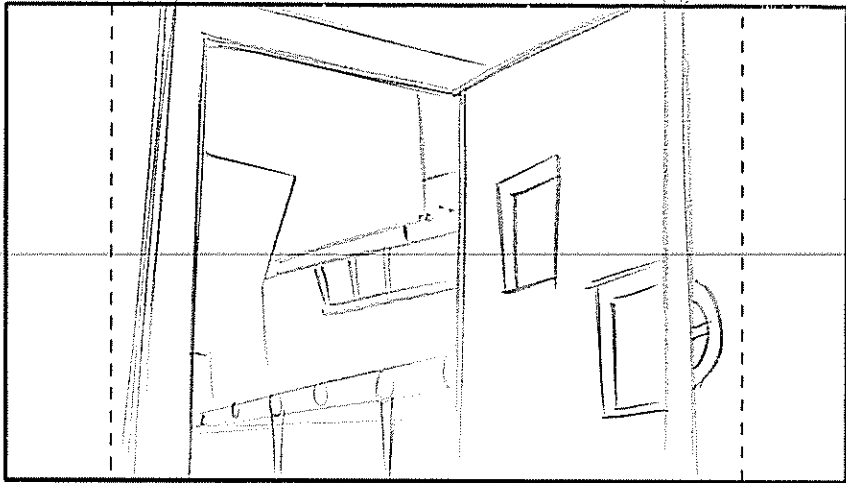

ACTION

CUT To FREEZER DOOR (LOW)

SCENE

PANEL 2/3

BG

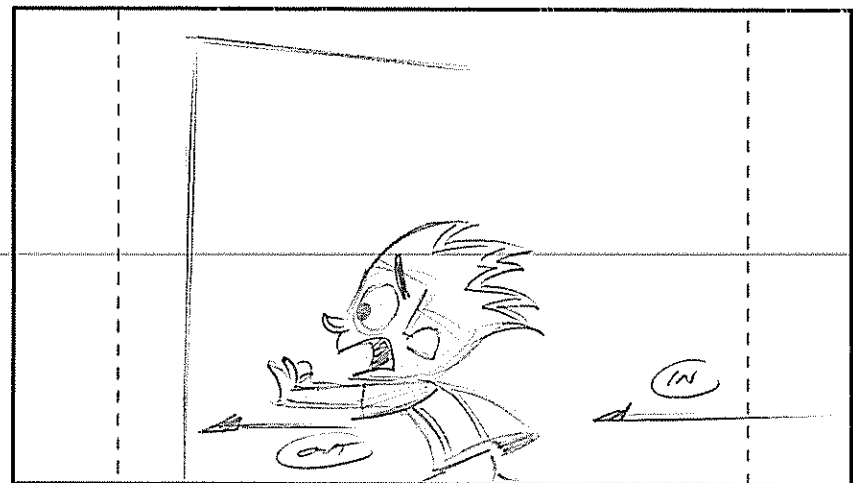

Johnny RUNS THROUGH!

DIALOGUE

Johnny = (KOR/LB)
AAAAA!

NOTES

202B



EPISODE: _____

PAGE: 153

SCENE

160

Cont'd

3/4

BG

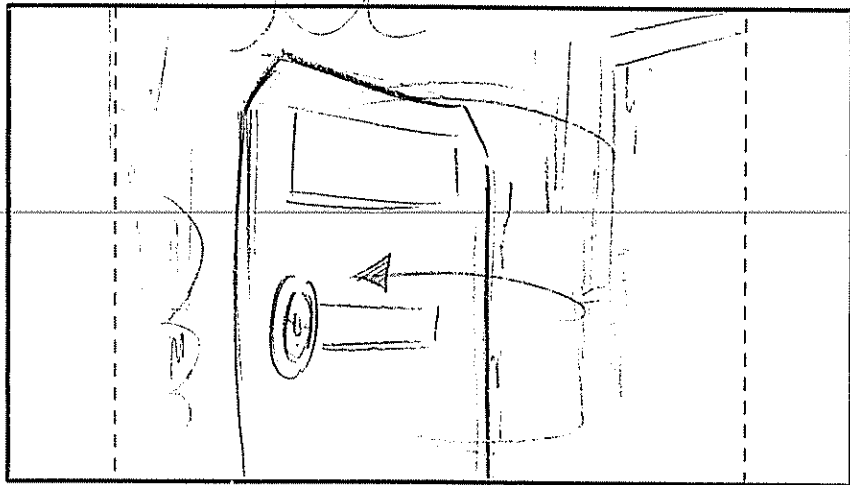

Sc 161
cut!

ACTION

- THE FREEZER DOOR SLAMS SHUT

DIALOGUE

NOTES



© 2006 Johnny Test Productions Inc "Johnny Test" TM Warner Bros Entertainment Inc All Rights Reserved

collidoscope animation studios

202B



122 - US -
- DIAL -

SCENE 162

BG



JOHNNY
IN

ACTION

(W)

PAN (A)

- THE TWINS ARE CONTENDING W/
THE MAD MONKEYS -

(B)

- JOHNNY RACES INTO
THE LAB

DIALOGUE

88. MARY
UH, I don't think they like this recipe
either.

89. JOHNNY
Dukey's now a Mega-mint chip and
if I don't get him out in three
minutes he'll freeze!

NOTES





12 - VIS -

SCENE 162A

PANEL

BG

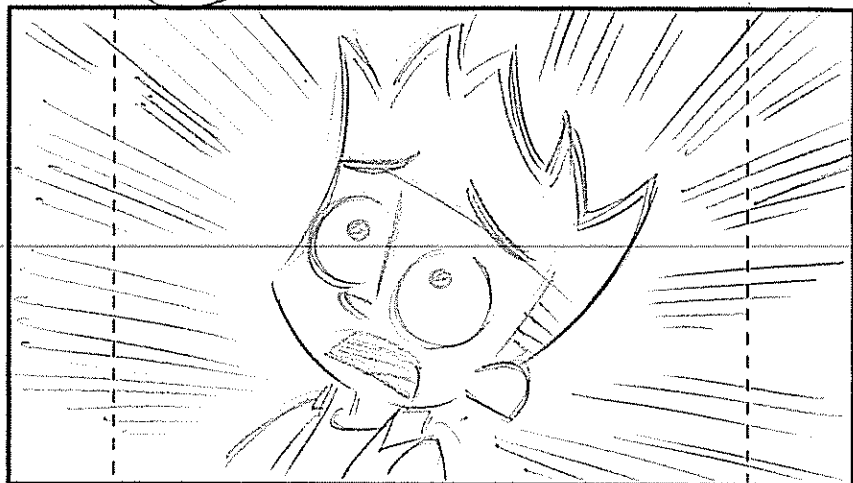

SCENE

PANEL

BG

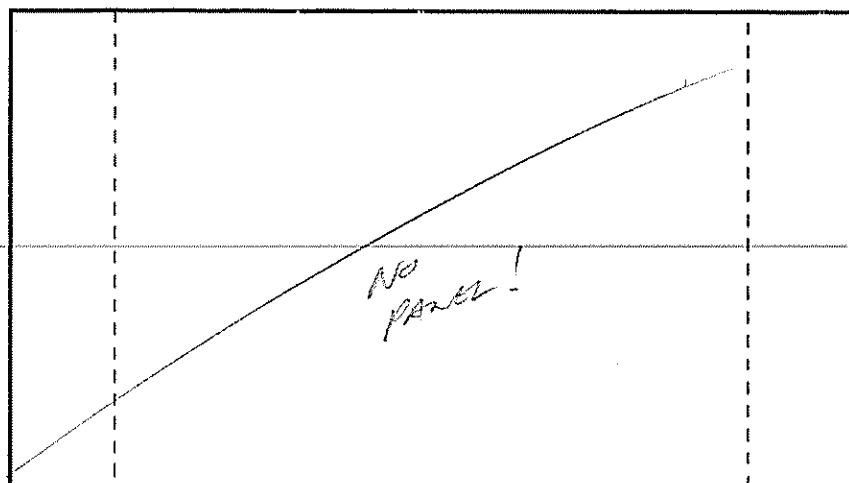

ACTION

cut close on Johnny.
(TILT)

DIALOGUE

Johnny: (canto)
Follow!

NOTES



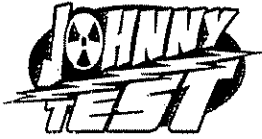

(R2) - PHONES
- DIAL

(R3) - VIS -
- DIAL

SCENE 163

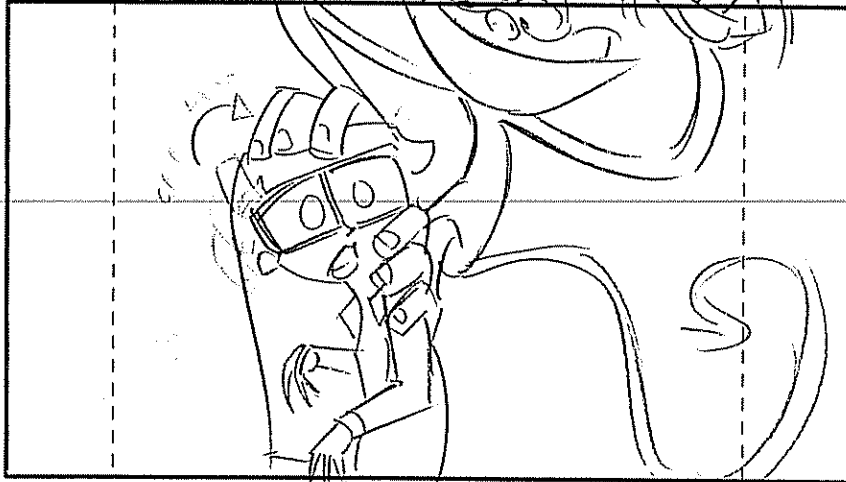

SCENE

PANEL

2/2
BG

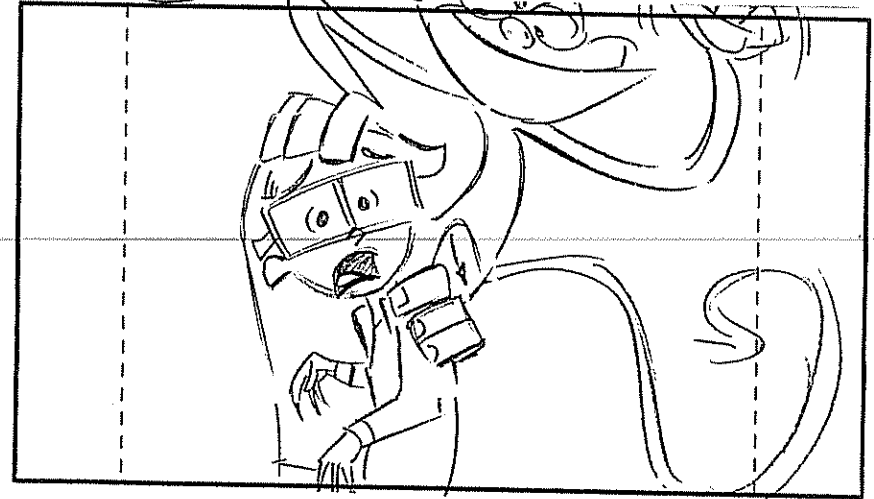

ACTION

(Handwritten initials)

- SUSAN W/ MONKEY -- (HE ADJUSTS HIS GRIP AND SHAKES HIS FIST)

DIALOGUE

90. SUSAN
We have our own emergency,

NOTES

IF THESE MONKEYS DON'T EAT SOMETHING TASTY SOON, THEY'RE GONNA BITE US!



© 2006 Johnny Test Productions Inc "Johnny Test" TM Warner Bros Entertainment Inc



2028

RE - PEST

EPISODE: _____ PAGE: 155A

RE - PANTS

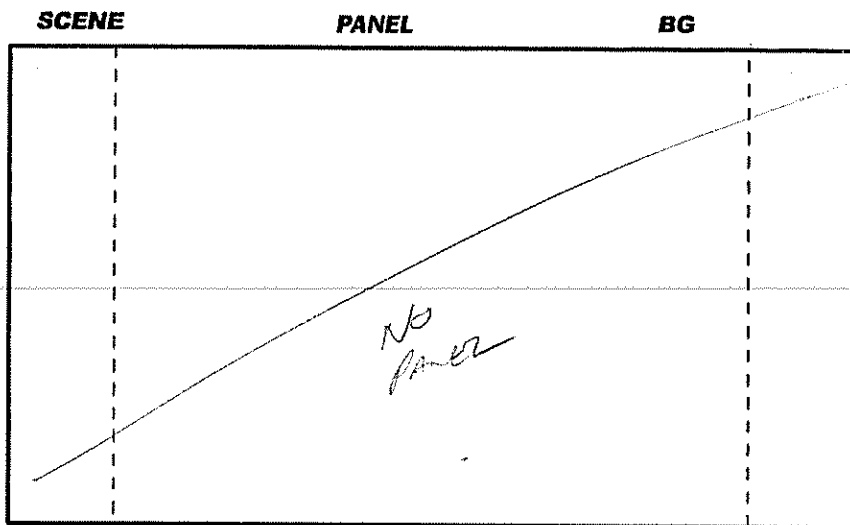

ACTION

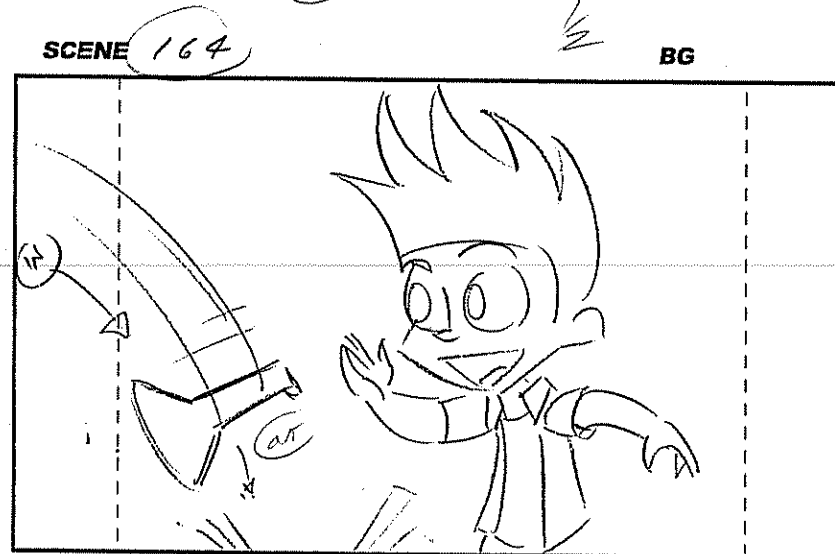

CUT BACK TO JOHNNY AS BEYBLOR FALLS THROUGH SE!

DIALOGUE

Really?

91. JOHNNY

SFX:
(CRASH!)

NOTES

All Rights Reserved

collideoscope animation studios



KE - Dial.

RR - VS

SCENE 164 artb PANEL 2/2 BG

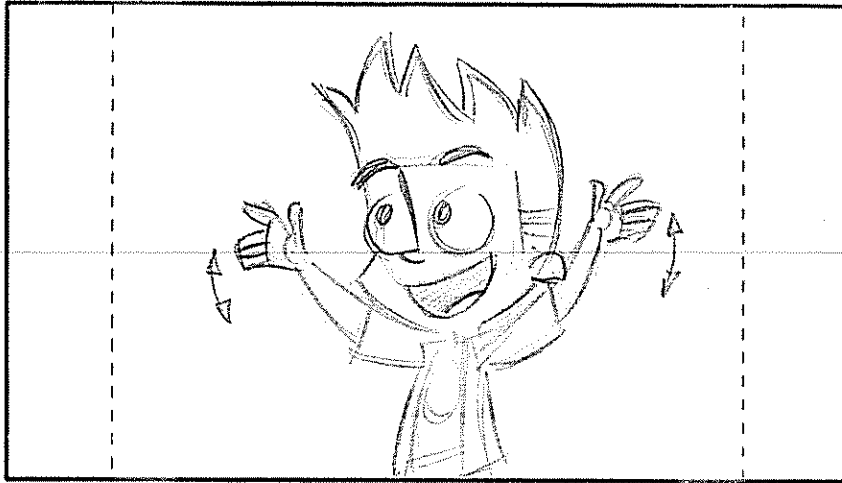

ACTION

Johnny waves to monkeys.

SCENE 164A 1/1 BG

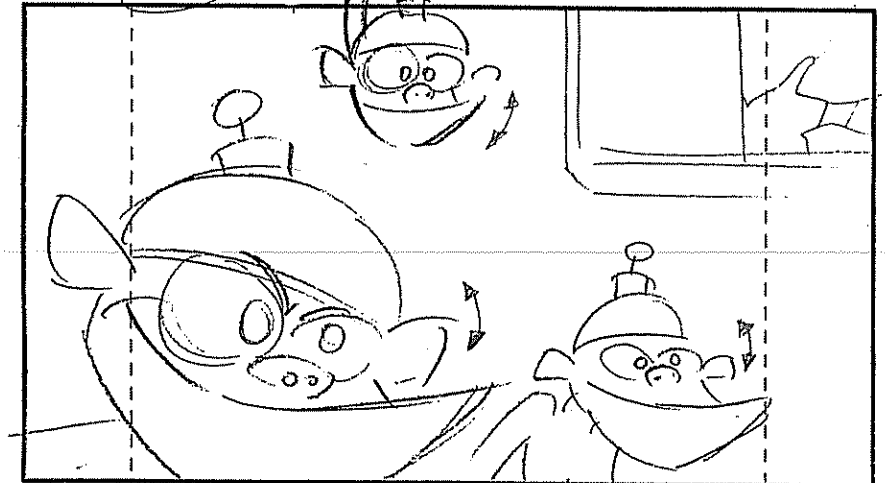

CUT

MONKEYS COME TO ATTENTION & NOOD IN AGREEMENT!

DIALOGUE

(91) Johnny: (CANTO)
HEY, ARE YOU GUYS TIRED OF TESTING
BARF...

Johnny: (CANTO 2/2)
... AND WANT TO TASTE THE BEST
ICE CREAM...

NOTES

202B

(P2) - B.#



(P2) - VS -
- DIAL.

EPISODE: _____ | PAGE: 156A

SCENE

164/2

1/2

BG

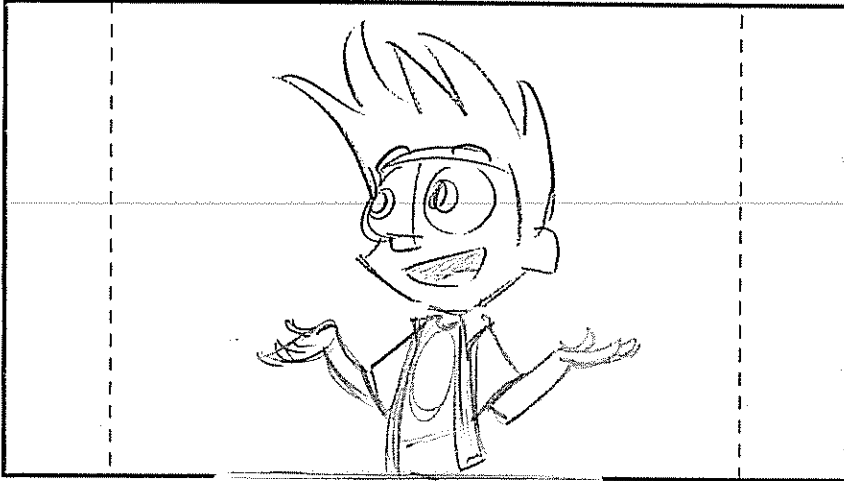

SCENE

2/2

BG

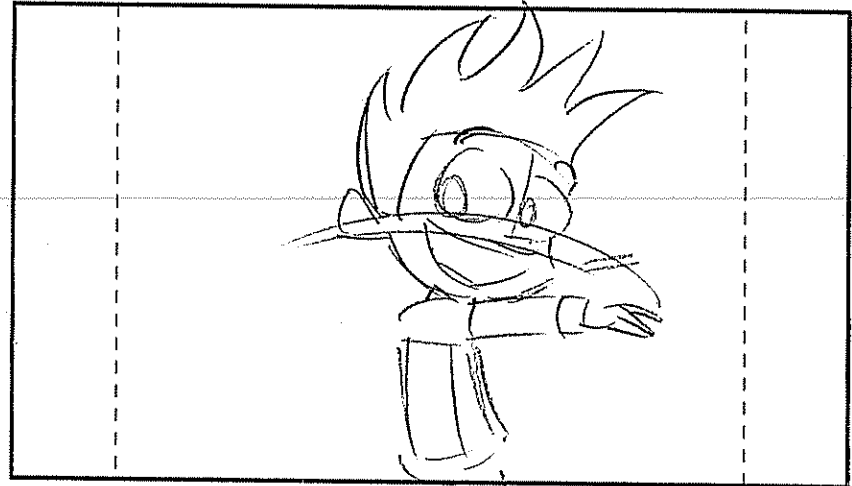

ACTION

(A)

BACK TO Johnny.

DIALOGUE

(91) Johnny: (confid)

... IN THE WORLD?

(92) Johnny:

Favor me!

NOTES



© 2006 Johnny Test Productions Inc "Johnny Test" TM Warner Bros Entertainment Inc All Rights Reserved

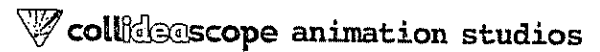

2028



(P2 - VIS
Action)

EPISODE: _____

PAGE: 157

SCENE 165

k BG

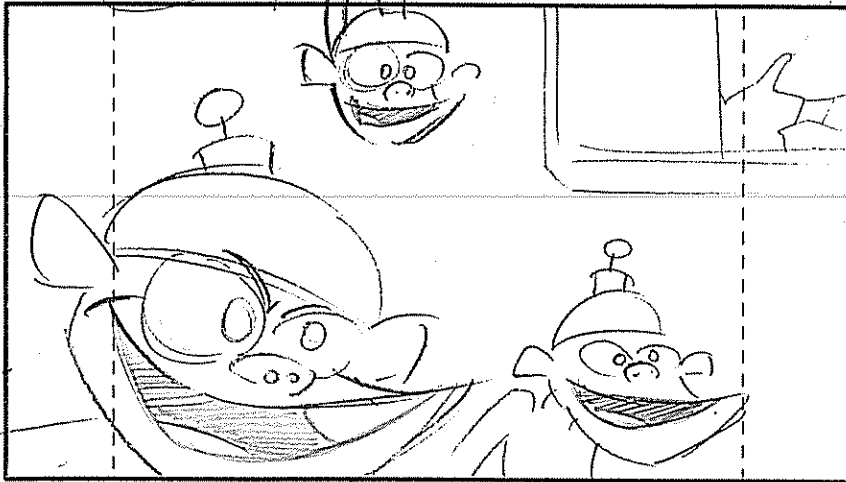

SCENE 166

k BG

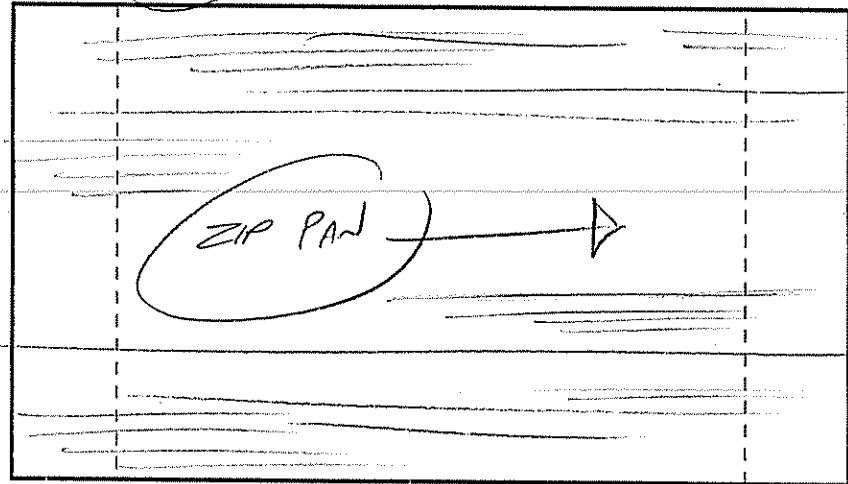

ACTION

(CR)

To the Monkeys
Monkeys

(CR)

ZIP PAN!

DIALOGUE

Monkeys -
(WASCA)

NOTES



202B



(R2) - VIS.
- ACTION.
- DIR.

(R2) - ACTION
- DIR.

SCENE (167)

BG

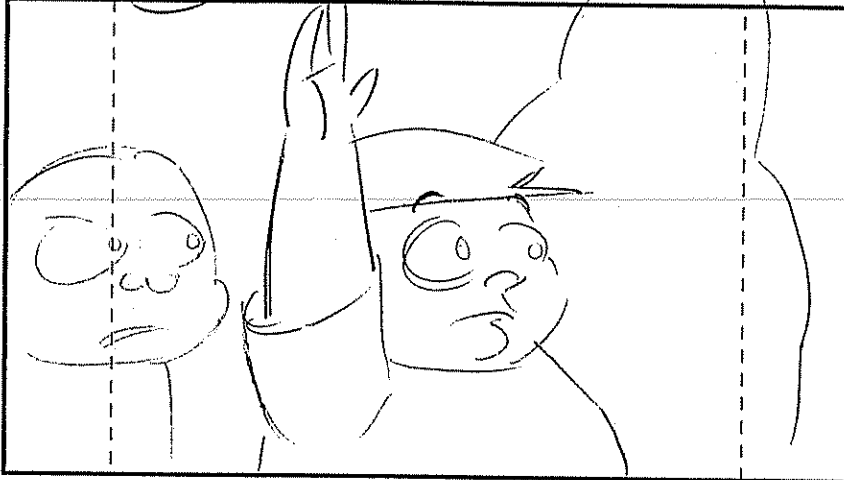

SCENE (168)

BG

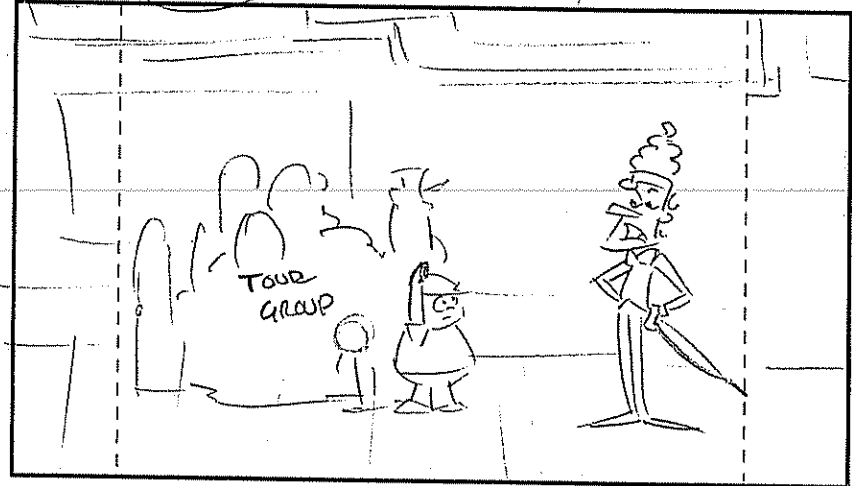

ACTION

(CUT) BACK WITH THE TOUR, CHUBBY KID WITH RAISED HIS HAND

(CUT) WIDE ON GROUP

DIALOGUE

(93) TOUR GUIDE: (c/s)
FOR THE LAST TIME...

93. TOUR GUIDE (Cont'd)
we DO NOT use real
monkeys in our Monkey Chunk.

NOTES



202B



SCENE 168 *Cont'd* 2/4 BG

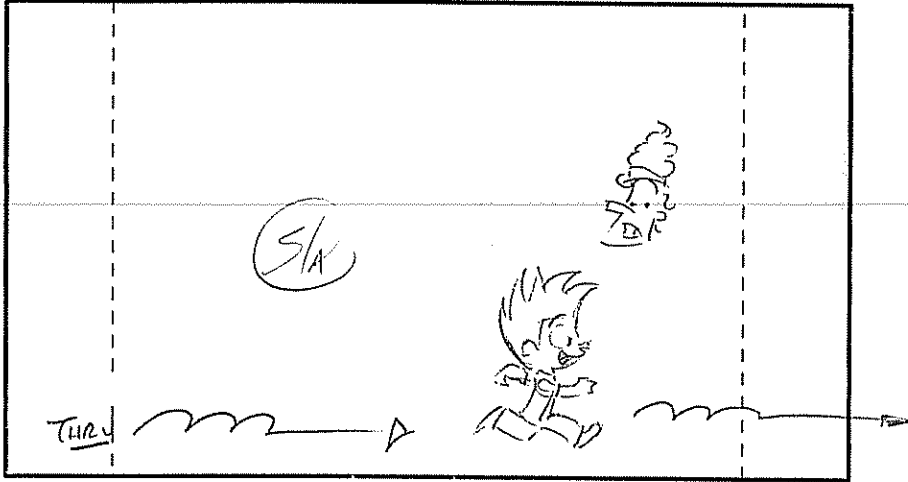

KE - DIRTY
SCENE 3/4 BG

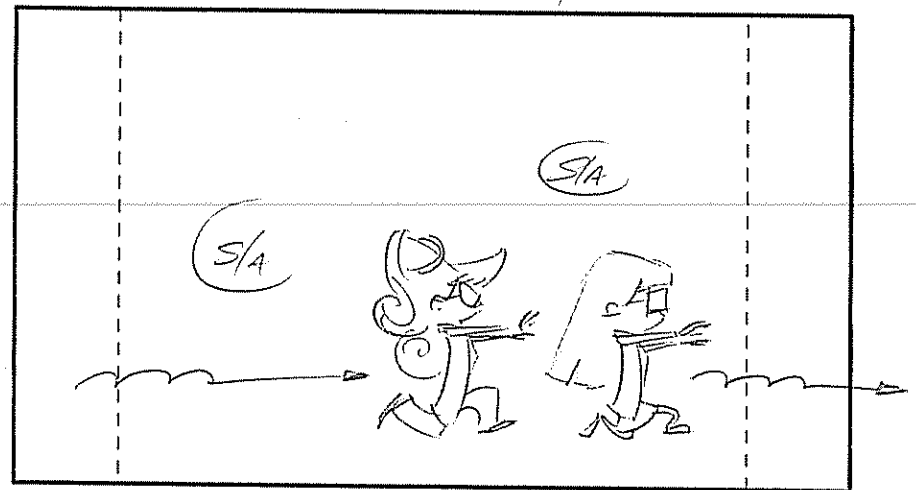

ACTION

Johnny RUNS THROUGH SC!

MARY & SUSAN RUN THROUGH SC!

DIALOGUE

94. JOHNNY
Okay monkeys, LET'S GET IN THAT ICE CREAM!

*MARY/SUSAN =
(SCREAMS) →*

NOTES



202B



(R2) - DMC

SCENE 168 cont'd 4/4 BG

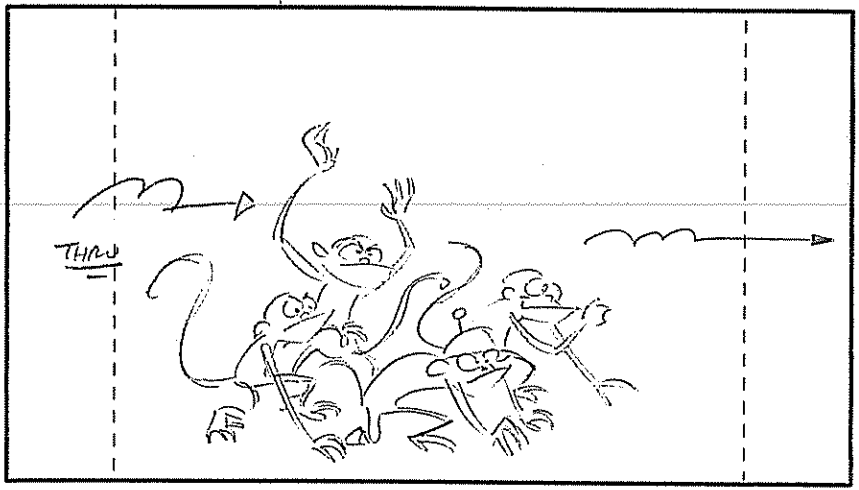

SCENE (169) 1/2 BG



ACTION

- MONKEYS RACE THRU

(cut)

- CHUBBY KID IS OVERWHELMED

DIALOGUE

Monkeys
(WAAAA)

95. CHUBBY KID
THEY REALLY DO USE REAL MONKEYS!

NOTES



202B



*NO SC 170!

EPISODE: _____ | PAGE: 161

(R2) - PANIC

SCENE 169 cont'd 2/2 BG

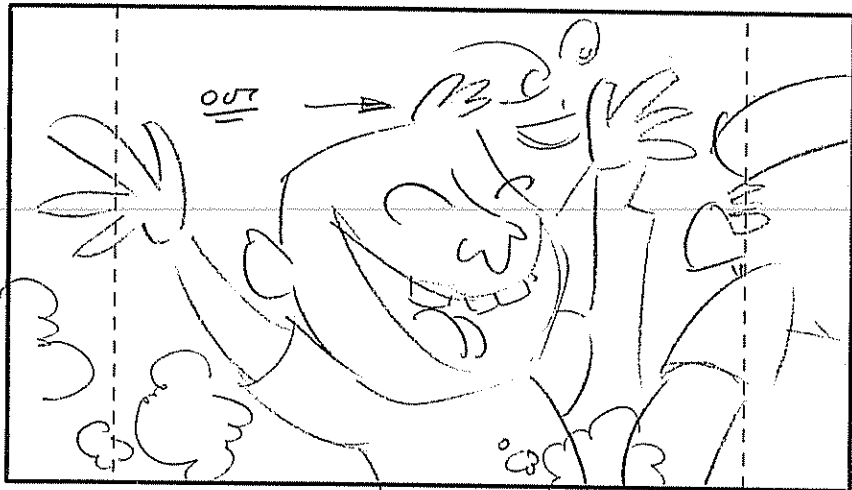

SCENE 171 1/3 BG

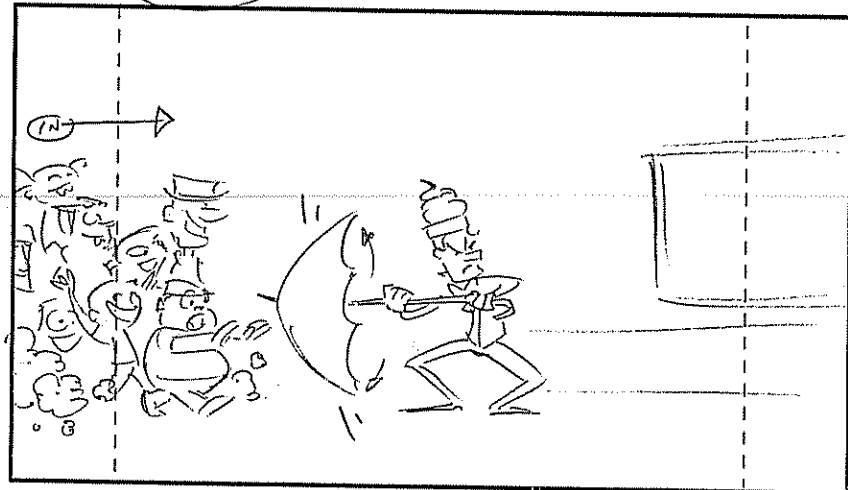

ACTION

Character runs out!

CUT - TOUR GUIDE LOOKS DS AT THE "INTRUDERS" & OPENS UMBRELLA -- TOUR GROUP RACES IN --

DIALOGUE

NOTES



© 2006 Johnny Test Productions Inc "Johnny Test" TM Warner Bros Entertainment Inc All Rights Reserved

collideascope animation studios

202B



EPISODE: _____ PAGE: 162

CR - V.S.

SCENE

171 cont'd

2/3 BG

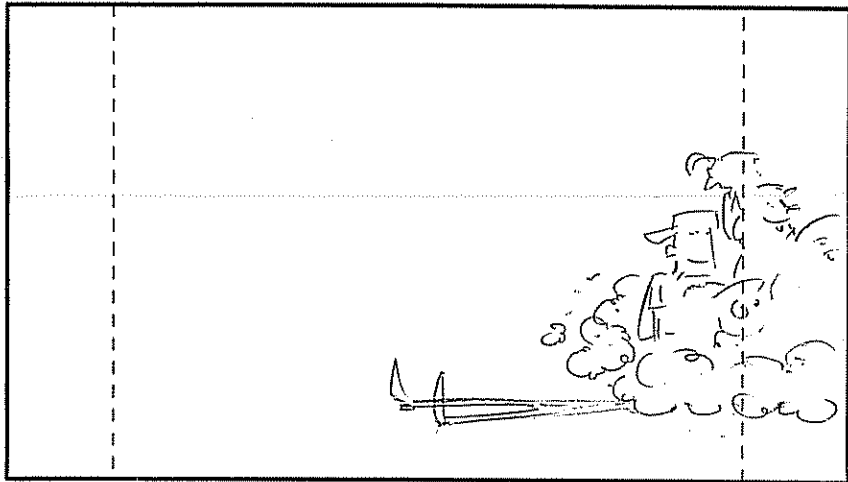

SCENE

PANEL

3/3 BG

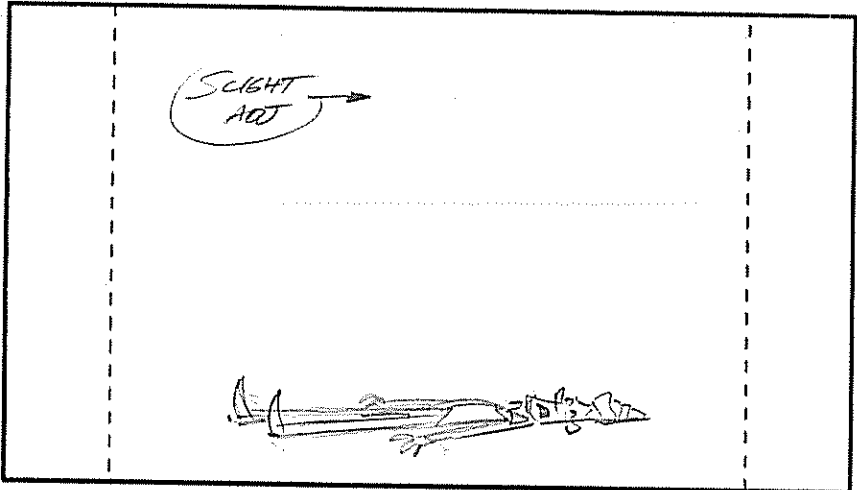

ACTION

-- AND FLATTEN THE GUIDE --

ACTION

CR - ADJ - RT →

DIALOGUE

TARGET GUIDE: (ADR)
(MORAN)

NOTES



SCENE 172

BG

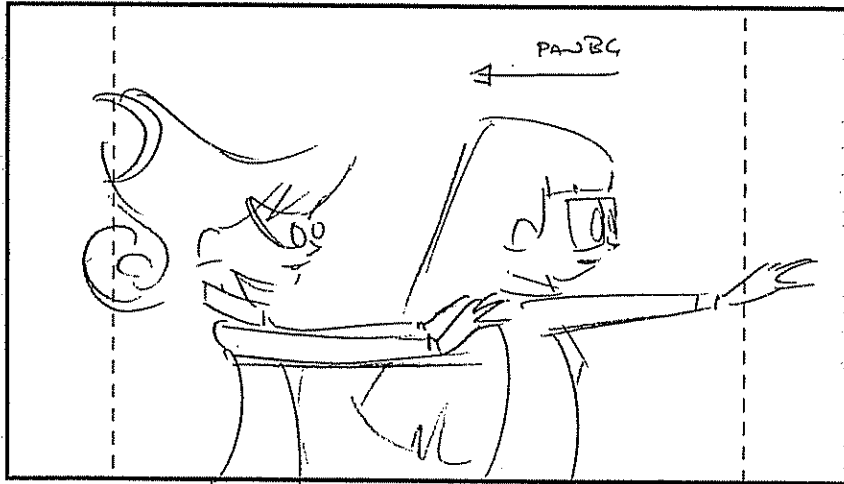

(Pan: BG ~~to~~)

THE TWINS RACING DOWN THE HALLWAY --

SCENE

PANEL

BG

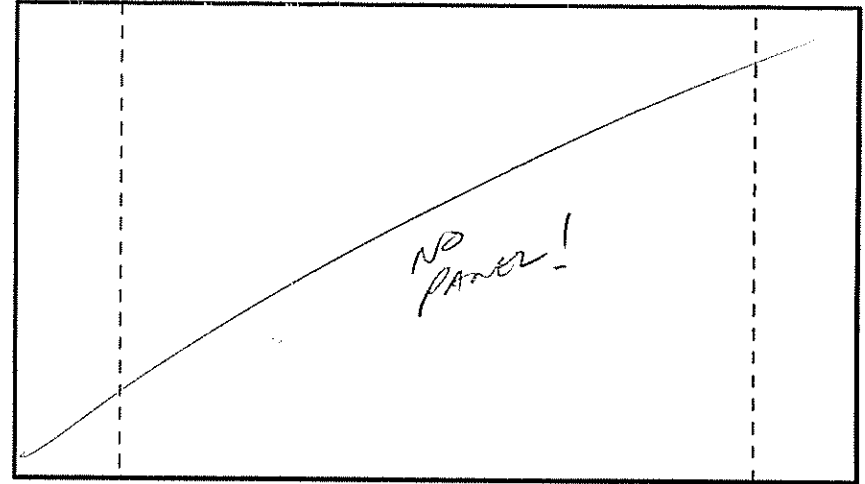

DIALOGUE

NOTES

202B



SCENE (173) 1/3 BG

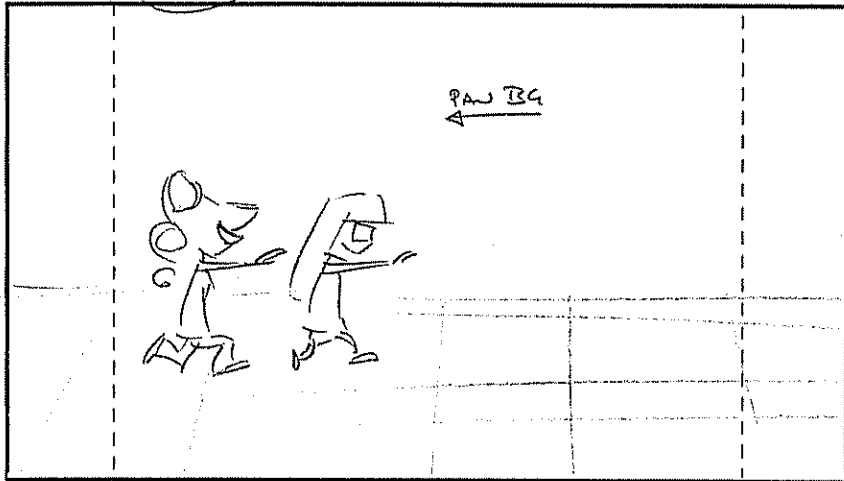

SCENE 2/3 BG

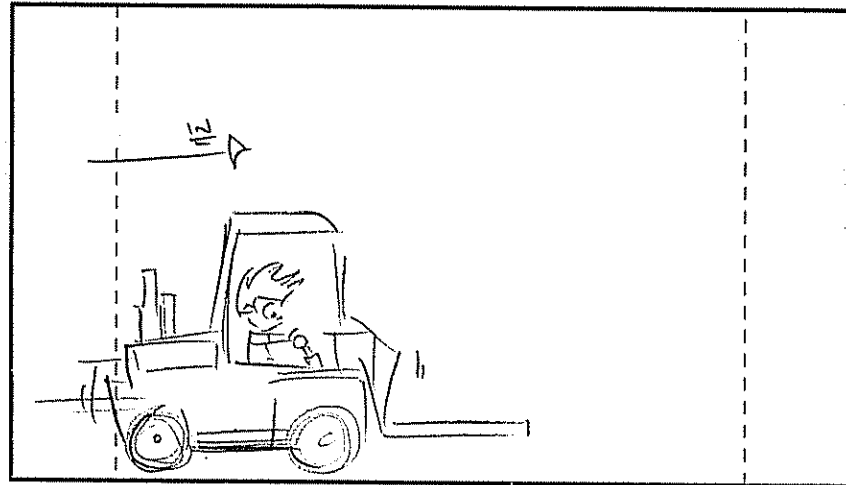

ACTION

(LT) WIDE -- TWINS CONT. (CYCLE)
(PAN BG LT)

JOHNNY ENTERS IN FORKLIFT.
(CONT'D TWINS CYCLE)

DIALOGUE

96. MARY
We're not going to make it in time.

NOTES



2020



SCENE 173 CONT'D 2/3 BG



ACTION

- THE TWINS STOP
- JOHNNY HITS THE BRAKES

SCENE (174) 4/4 BG

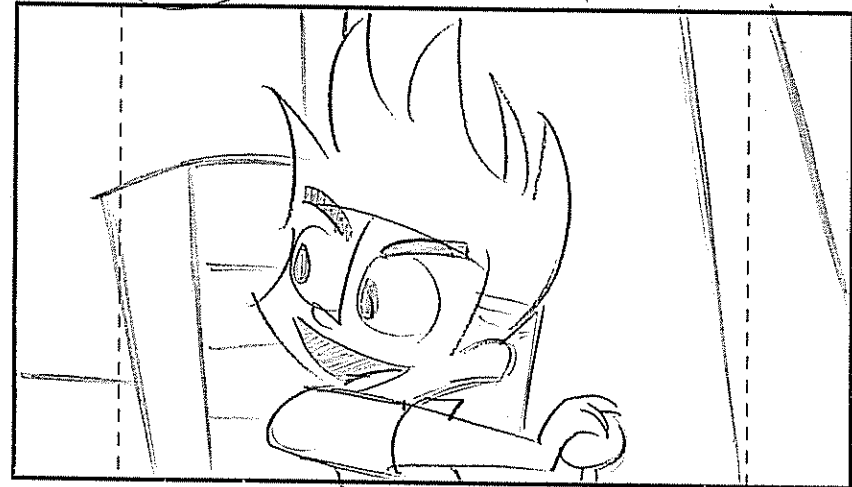

Close on Johnny.

DIALOGUE

97. JOHNNY
Yes we are, everyone jump on.

NOTES





202B

R3 - PANELED OUT.
R2 - PANELED # 15

R2 - DIAL -
- PANELED # 15

R3 - PANELED # 15.

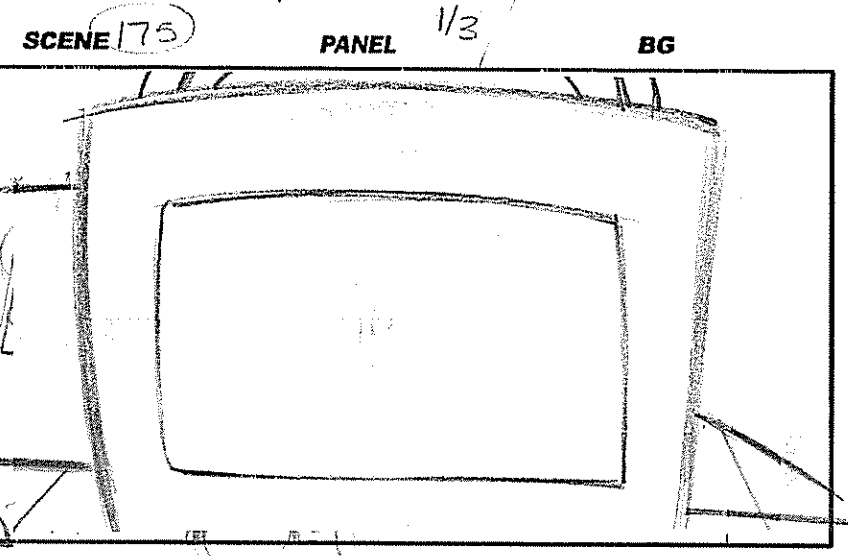
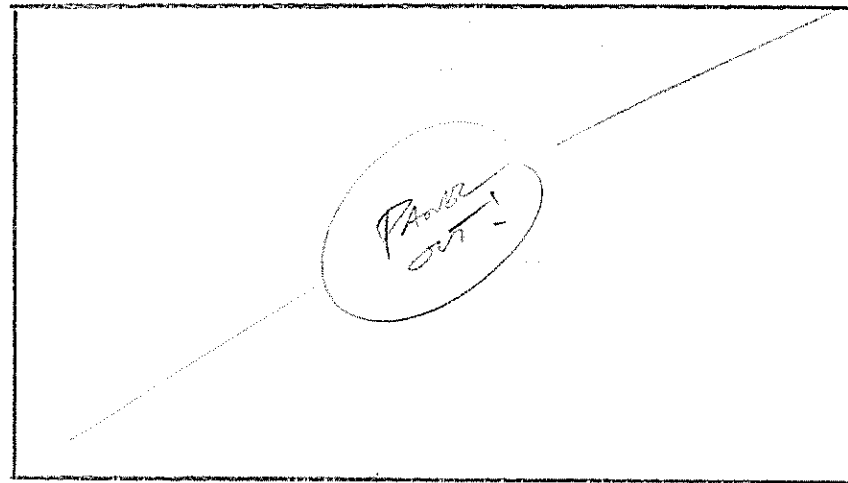

CUT (HALL) - TO CLOSE ON BACK OF FERRETT!

DIALOGUE

NOTES



R3



(R3) - VLS

(R2) - Panel #15

202B

(R3) - VLS

(R2) - NEW PANEL -

PAGE: 166

SCENE 175 cont'd PANEL 2/3 BG

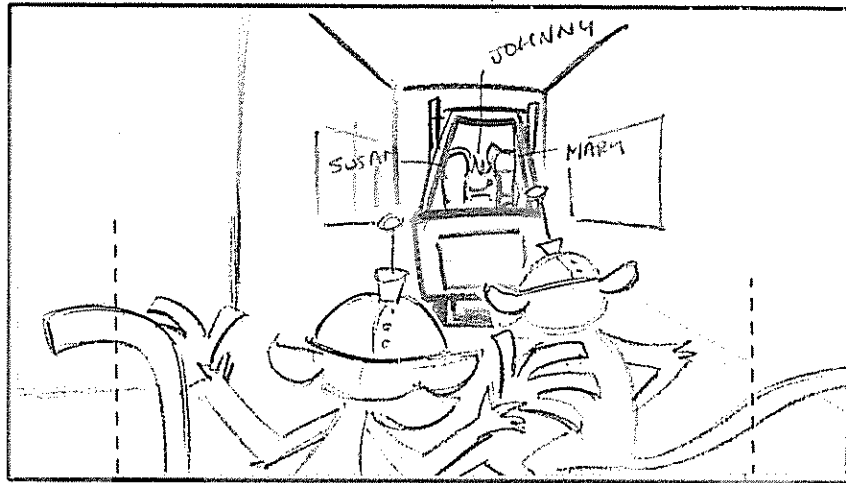

ACTION

DRIVES DOWN TALL!
- MONKEYS IN.

SCENE PANEL 3/3 BG

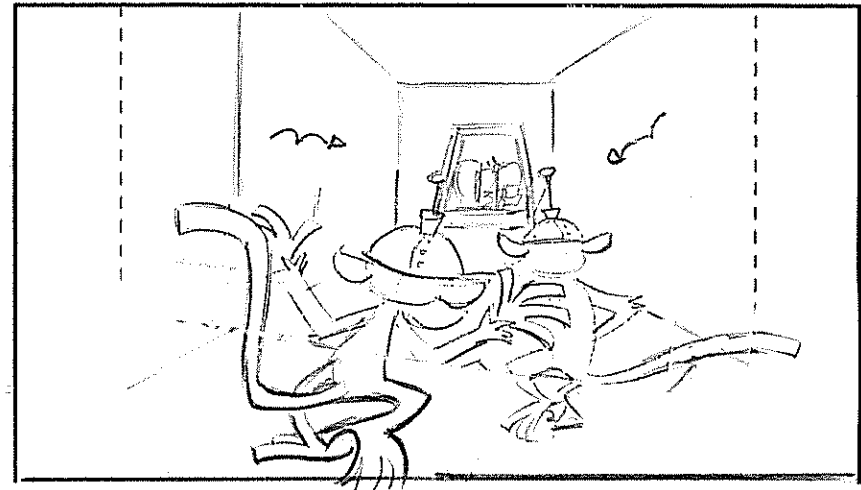

MONKEYS FOLLOWING FORKLIFT

DIALOGUE

Johnny: (c/s)
Hang on!

Monkeys:
(w/ous)

NOTES





202B

PAGE: 166A

(12) - DIRT -
- US -

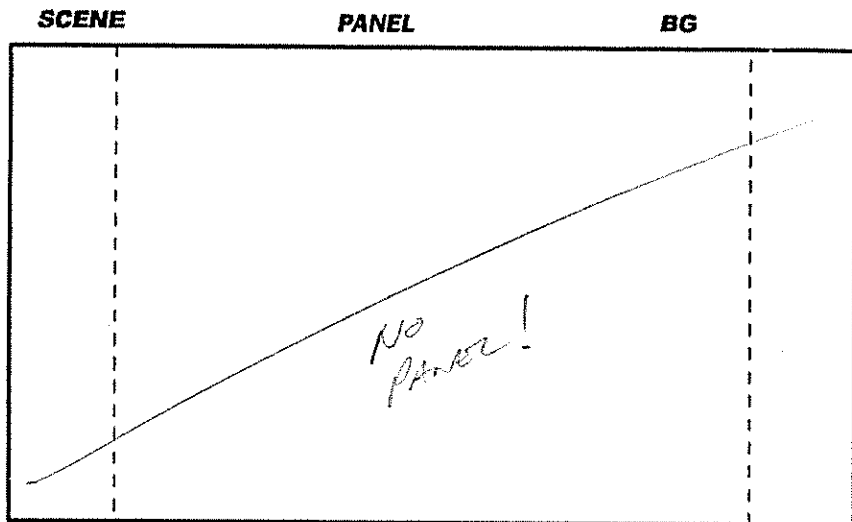

ACTION

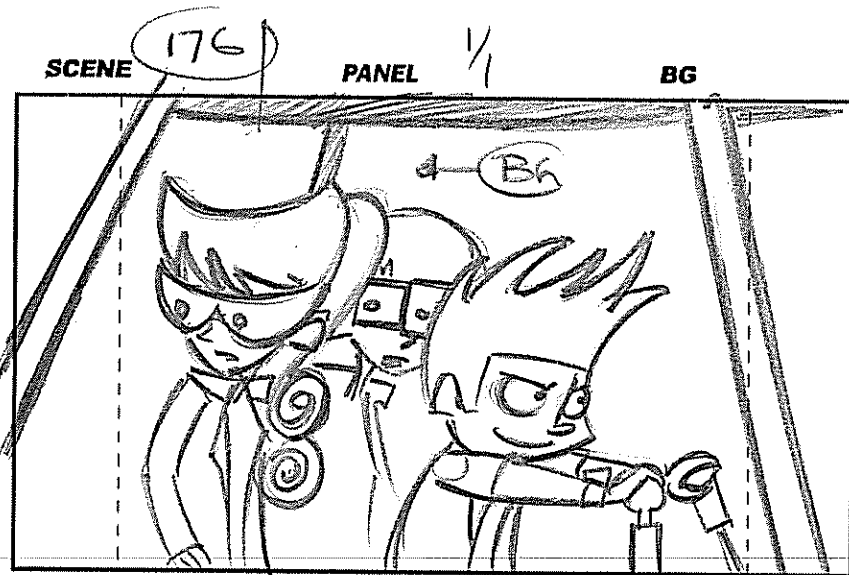

(Cut) INSIDE FORKLIFT ON JOHNNY + CS.
PAN-BG ← LT

DIALOGUE

SCREEN:
SECURITY IN THIS PLACE
IS HORRIBLE -

NOTES



(R2) *NO SC 178!

2028

(R2) - VIS
- ACTION

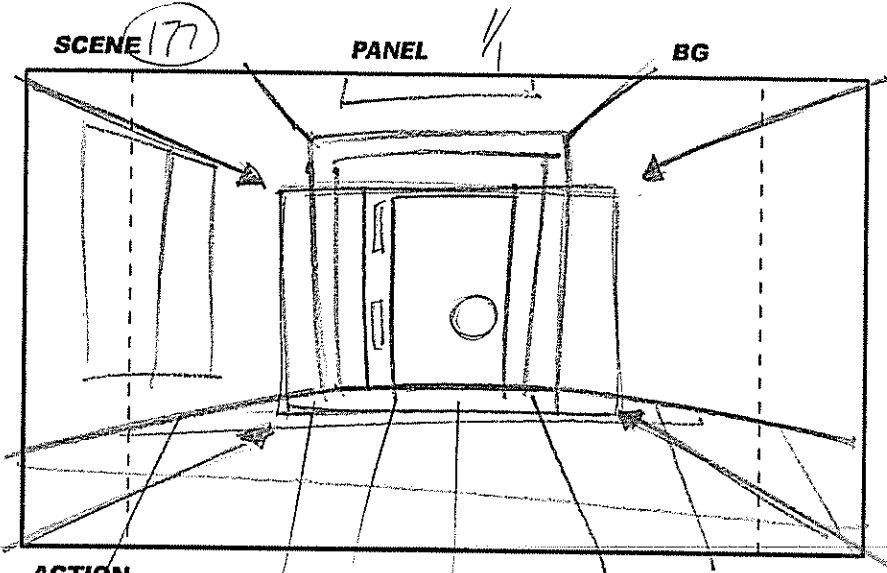

ACTION
CUT ON JOHNNY'S P.O.V. OF
FREEZER DOOR TRK-IN

DIALOGUE

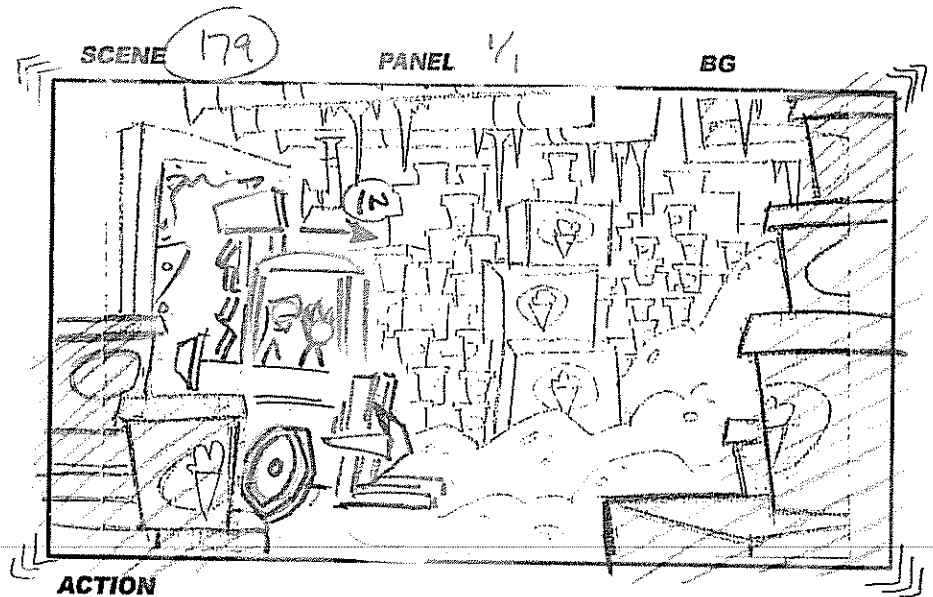

ACTION
CUT INTO FREEZER...
FORKLIFT SMASHES THRU DOOR
CAMERA SHAKE!

SFX:
(CRASH!)

NOTES

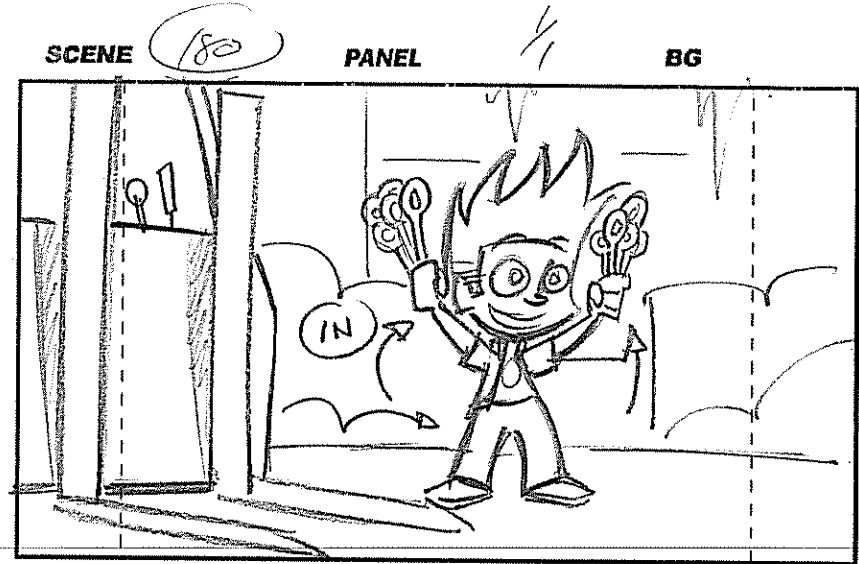
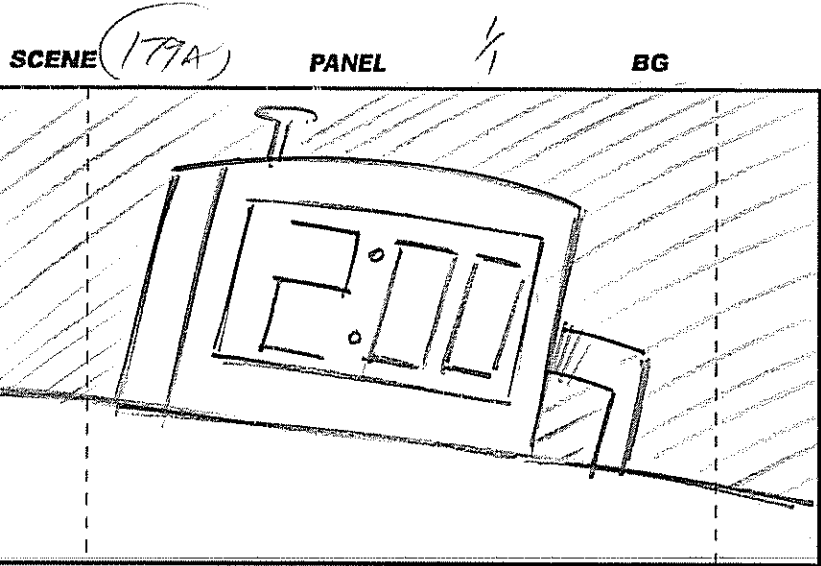

AT TO LCD CLOCK .

AT TO Johnny RAISING SPEED

DIALOGUE

Johnny:
START EATING!

NOTES

RS - VIS
- DIR 2

RS - VIS
- NOV/SC!

SCENE (181)

PANEL 1/1

BG

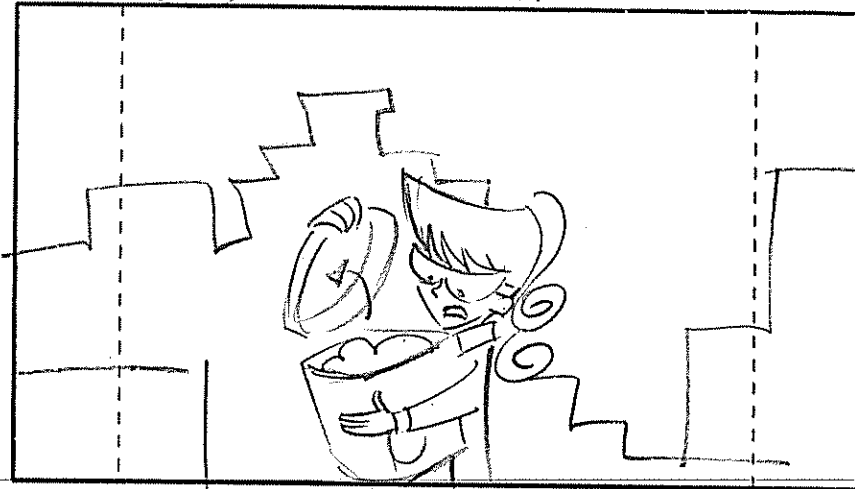

ACTION

CUR ON MARY

SCENE (181A)

PANEL

1/1

BG

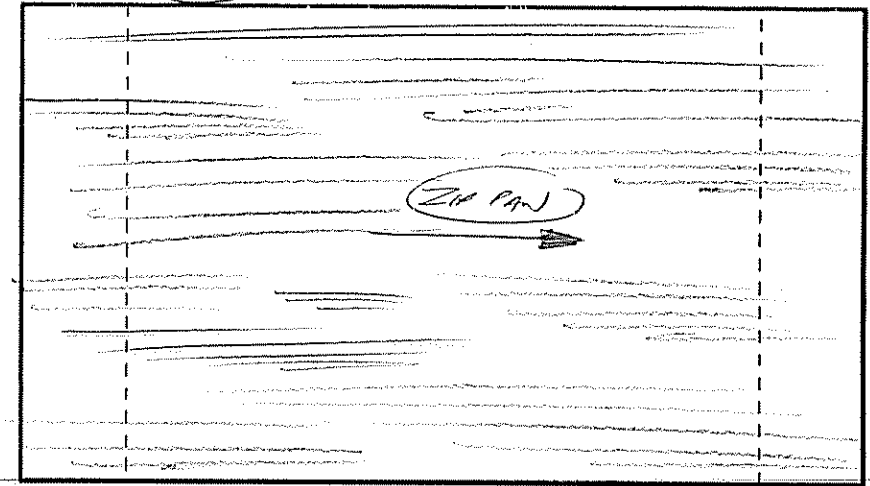

CUR TO ZIP PAN! →

DIALOGUE

MARY: (ADR)
NOT IN THIS ONE!

NOTES



(R3) -VIS
-NEW SC.
-DIAG.

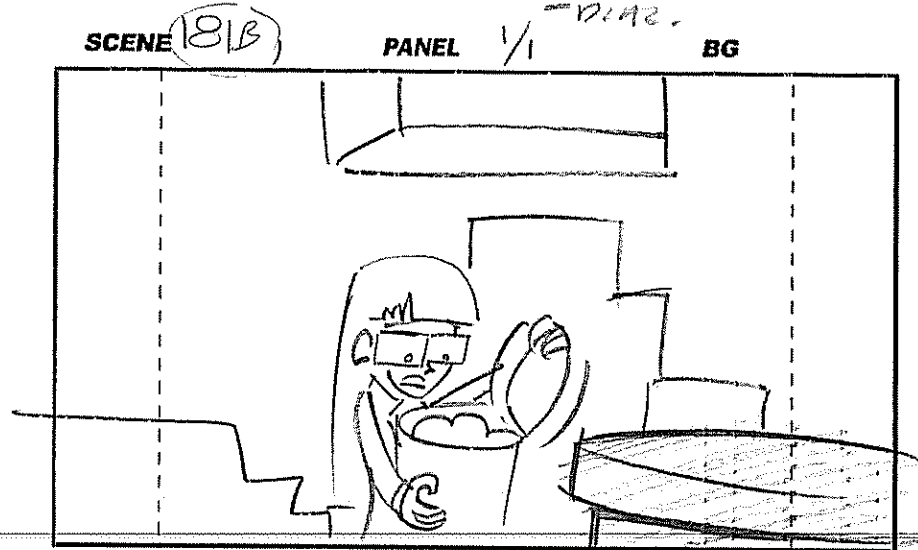
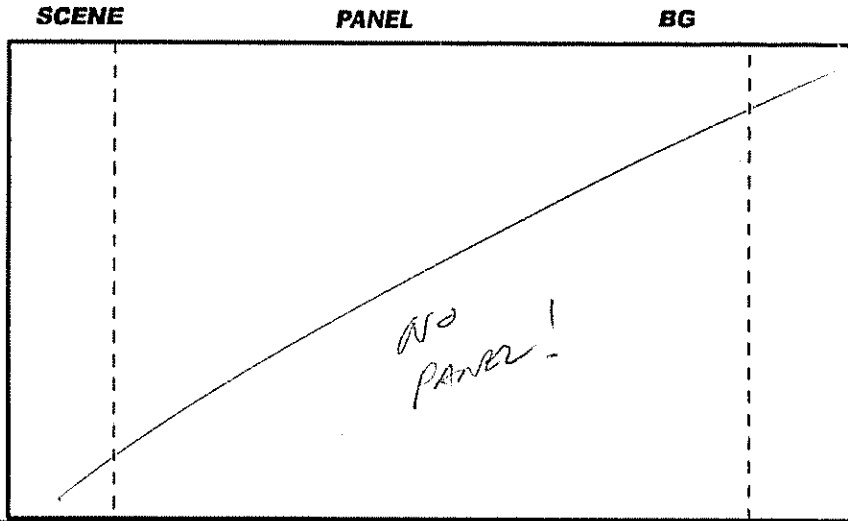

ACTION

(W) ON SUSAN,

DIALOGUE

SUSAN: (ADR)
NOT IN THIS ONE EITHER!

NOTES





R3 - PANEL WT.

202B

Followed by page # 169A

R2 - DIAL

R2 - DIAL

EPISODE: _____ PAGE: 169

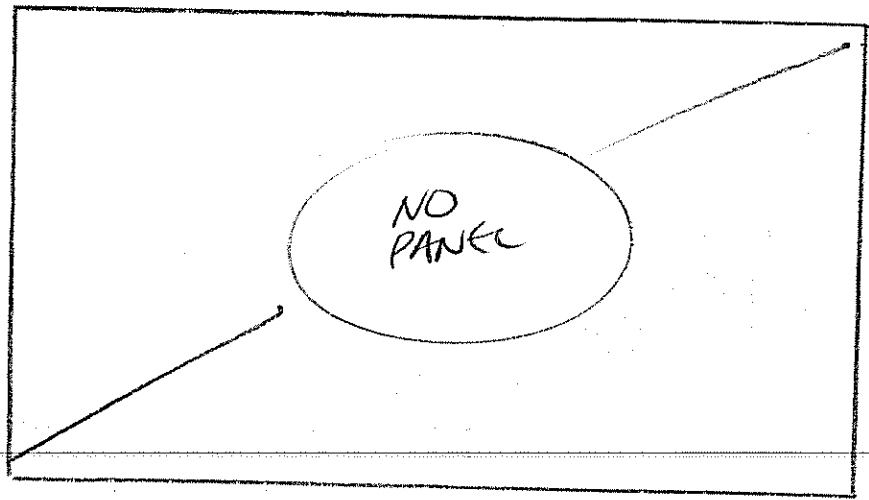

SCENE 182

1/2

BG

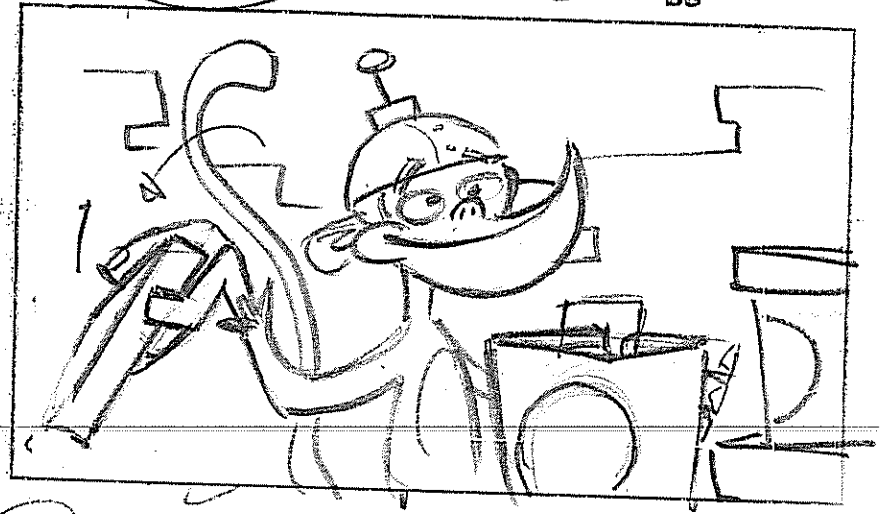

WT

- A MONKEY DEVOURS ICE CREAM

ACTION

DIALOGUE

NOTES



© 2006 Johnny Test Productions Inc "Johnny Test" TM Warner Bros Entertainment Inc All Rights Reserved

collidoscope animation studios

R3



202B

⊕ Pg. 169B NEXT

PAGE: 169A

Re-Dial

SCENE (82 cont.) PANEL 2/2 BG

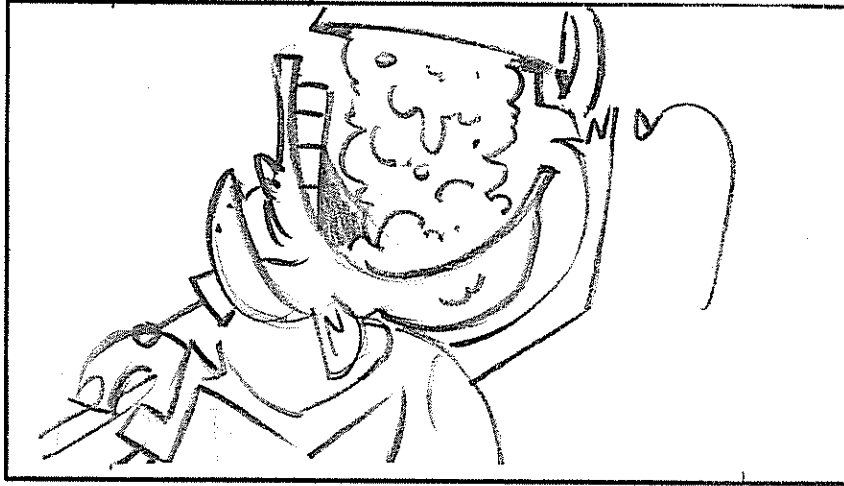

SCENE PANEL BG

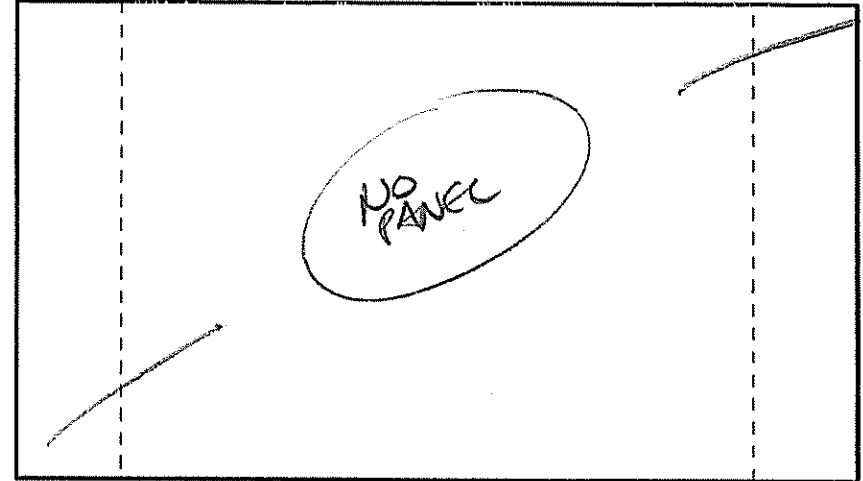

ACTION

DIALOGUE

[Faint handwritten notes]

NOTES





RB - VIS.

202B

PAGE: 169B

RB - DIA.

RB - VIS.

SCENE 183

PANEL

1/4

BG

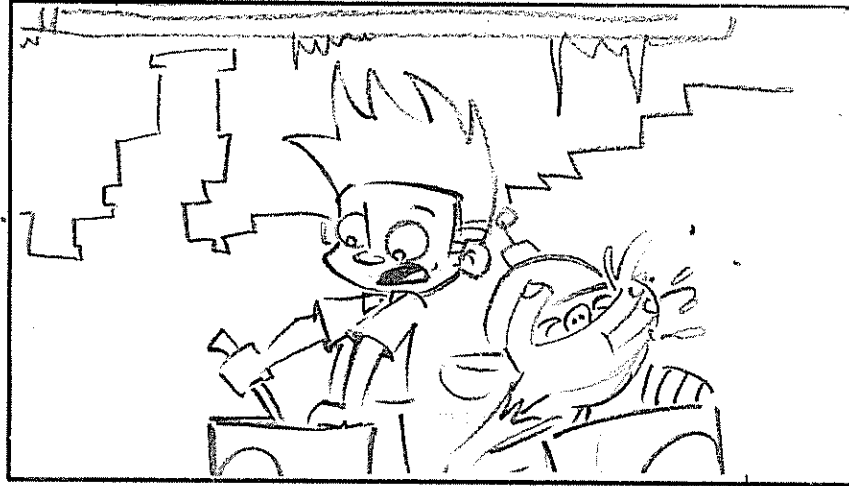

SCENE

PANEL

2/4

BG



ACTION

cup

ON JOHNNY + MONKEY...

MONKEY STARTS EATING ICE CREAM.

DIALOGUE

Johnny: (ADR)

KEEP EATING!

HE'S HERE SOMEWHERE!

NOTES



RB



P3-VIS

202B

PAGE: 169C

R2-DIAL

3/d

SCENE 183 CONT'D

PANEL

BG

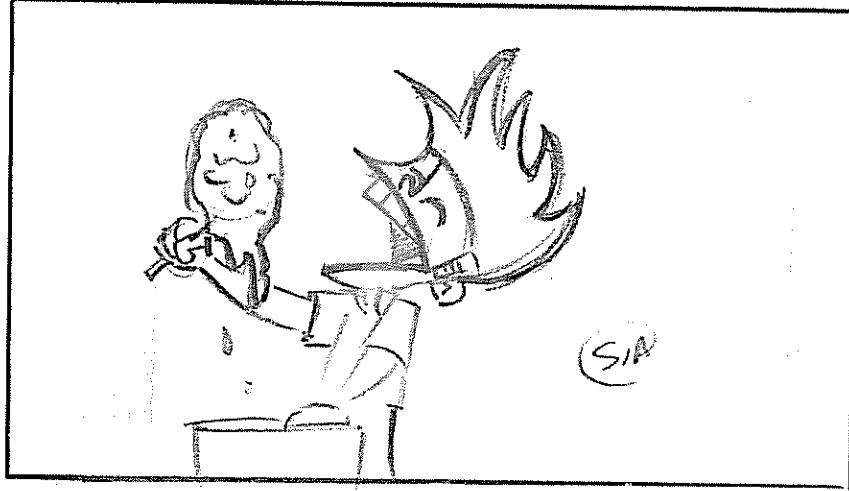

SCENE

PANEL

BG

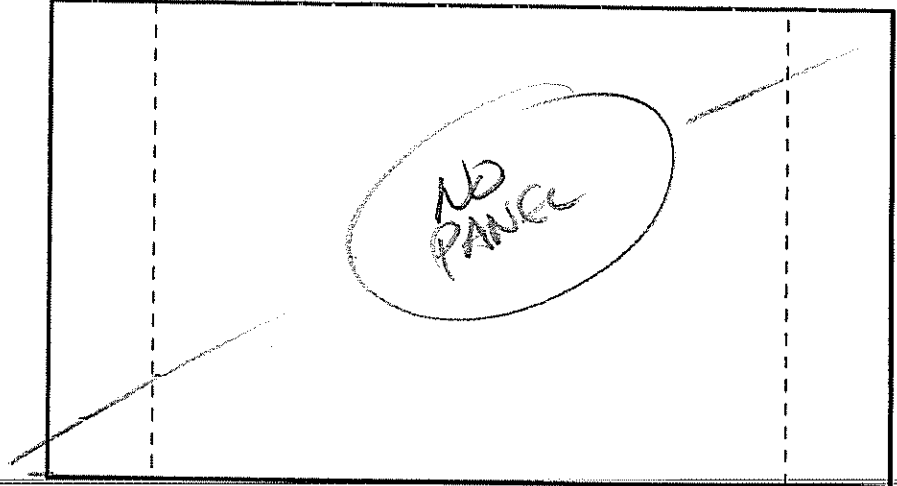

ACTION

Johnny ANTICS

DIALOGUE

NOTES



R3

202B



RE-DIAL

RE-DIAL

EPISODE: _____

PAGE: 170

SCENE 183

9/4/11

BG



ACTION

- JOHNNY & SOME MONKEYS
DEVOUR MORE ICE CREAM

SCENE 184

184

BG



CUP

- A MONKEY EATS WITH HIS HANDS
- ANOTHER EATS WITH HIS HEAD!

DIALOGUE

NOTES



© 2005 Johnny Test Productions Inc. "Johnny Test" TM Warner Bros Entertainment Inc All Rights Reserved

collidescope animation studios

202B



22 - DIAL

EPISODE: _____

PAGE: 171

22 - DIAL

SCENE

185 1/1

BG

SCENE

186 1/1

BG

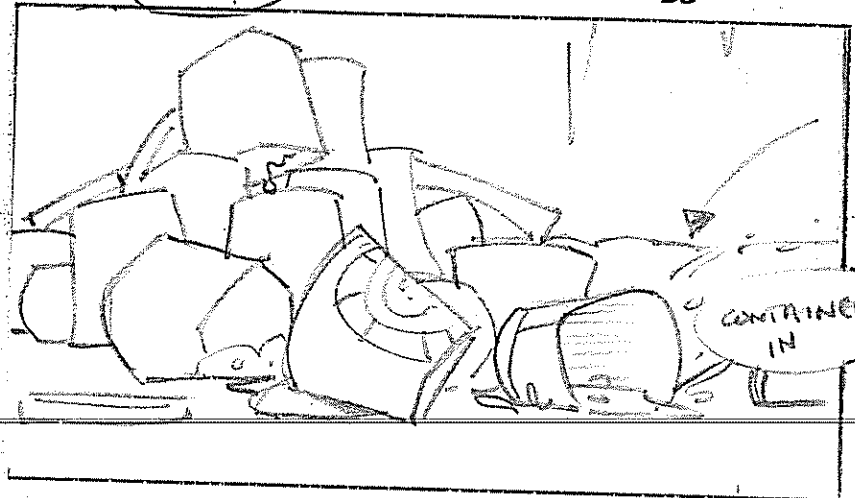
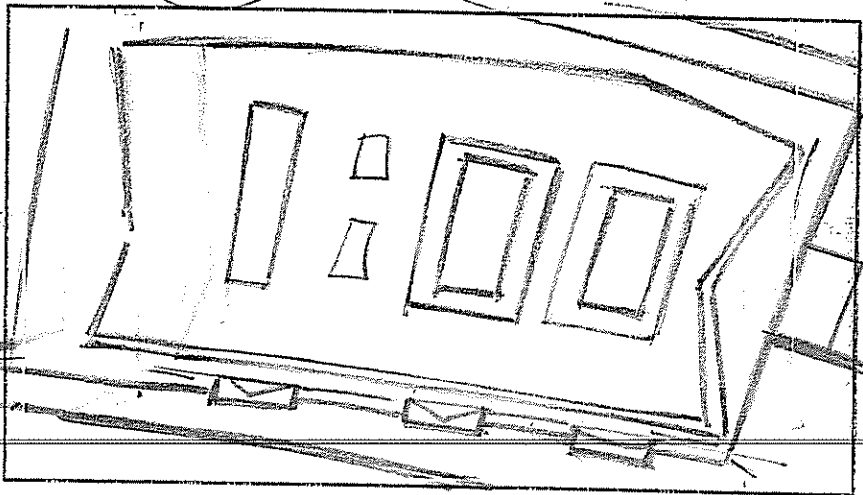

ACTION

CUT TO LED -- ONE MINUTE LEFT!
(CLOCK CHANGES TO "1" MINUTE)

CUT -- A PILE OF EMPTY TUBS BEGINS TO GATHER.

DIALOGUE

NOTES



© 2006 Johnny Test Productions Inc. "Johnny Test" TM Warner Bros. Entertainment Inc. All Rights Reserved

collidoscope animation studios

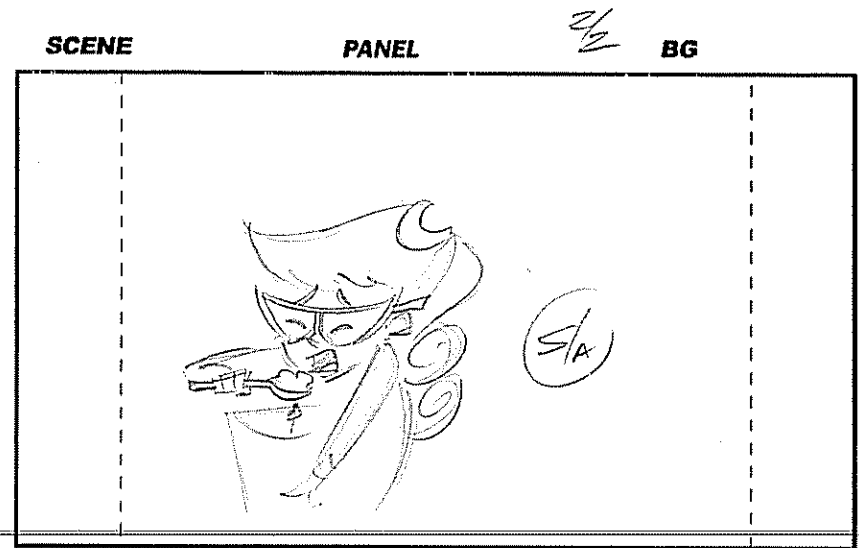
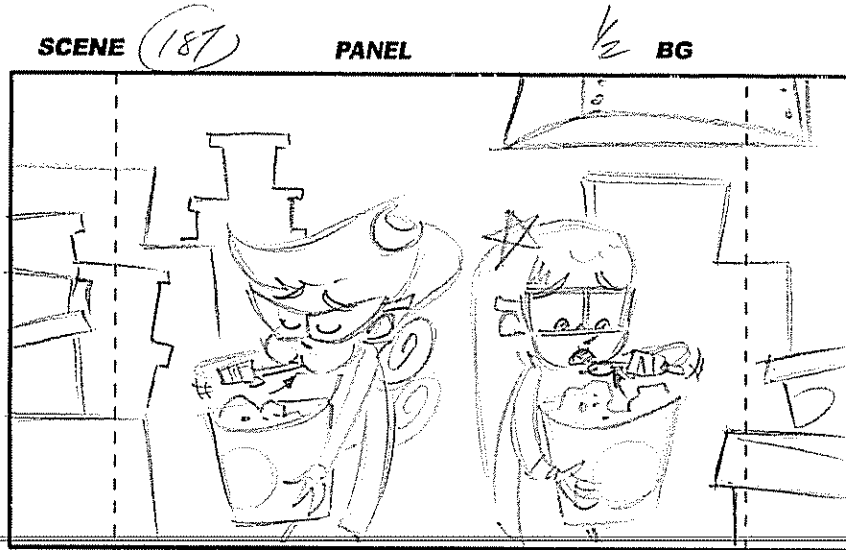

ACTION

(CUT)

TO THE TWINS GOBBLE
DOWN THE ICE CREAM!

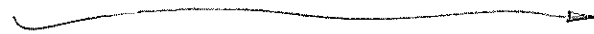

DIALOGUE

SUEAN (AOR)

IF WE EAT TOO FAST, WE'RE GONNA
GET AN...

MARY =

OUCH! ICE CREAM HEADACHE!

NOTES

2023



EPISODE: _____

PAGE: 173

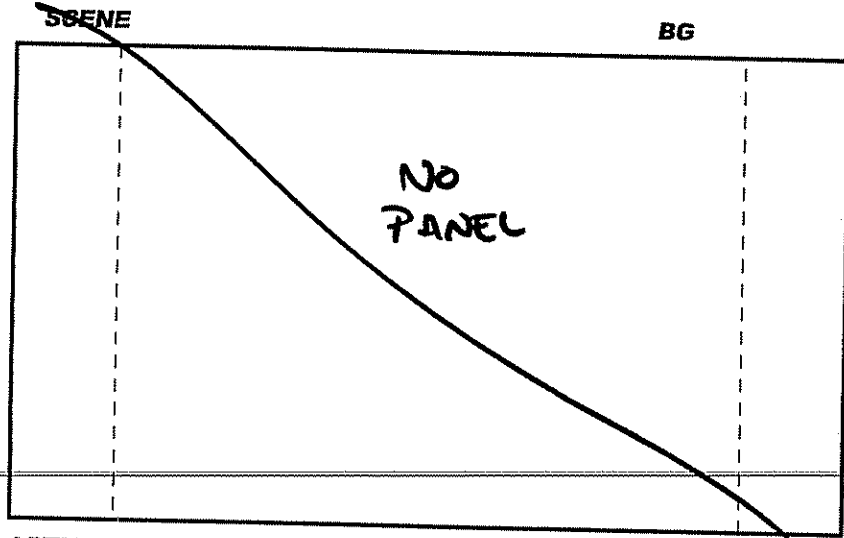

ACTION

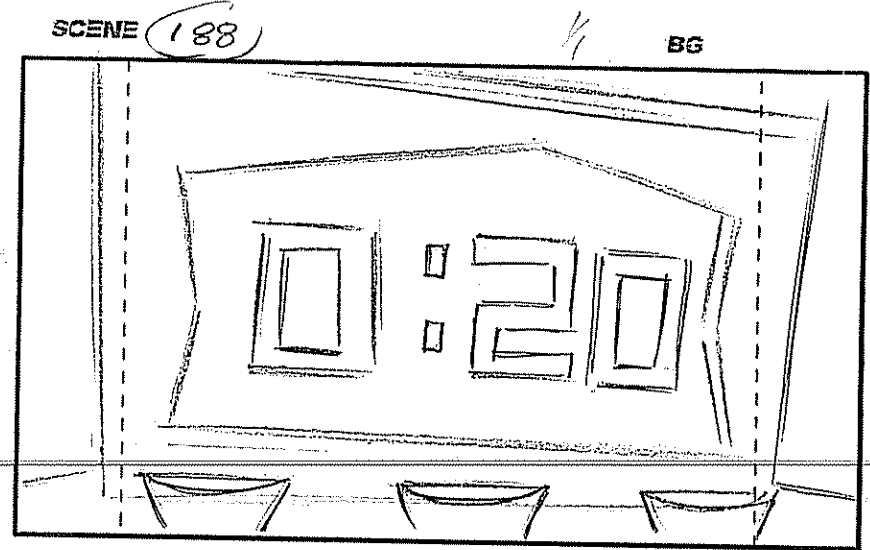

(CUT) TO T-MINUS 20 SECONDS!
DIGITAL CLOCK! (# CHANGES TO "20"
SEC.)

DIALOGUE

NOTES



© 2008 Johnny Test Productions Inc. "Johnny Test" TM Warner Bros. Entertainment Inc. All Rights Reserved

collidescope animation studios

(12) - PANELS
- VS.

SCENE (189)

PANEL

1/4

BG

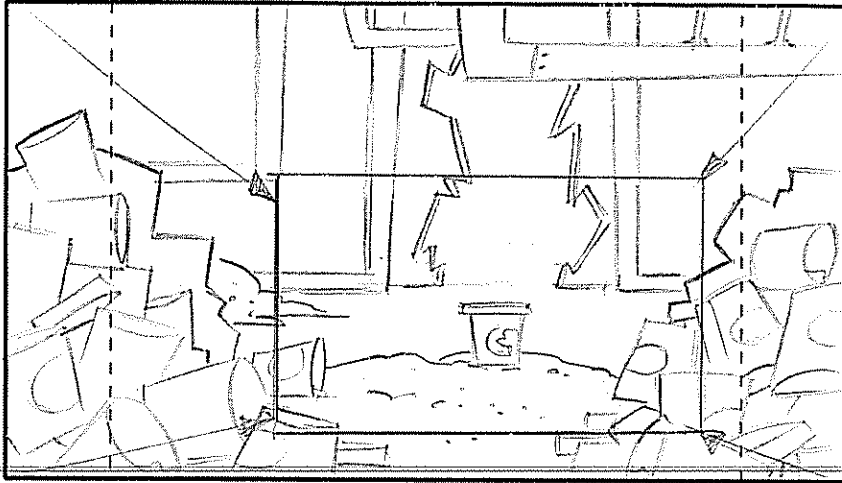

SCENE

PANEL

BG

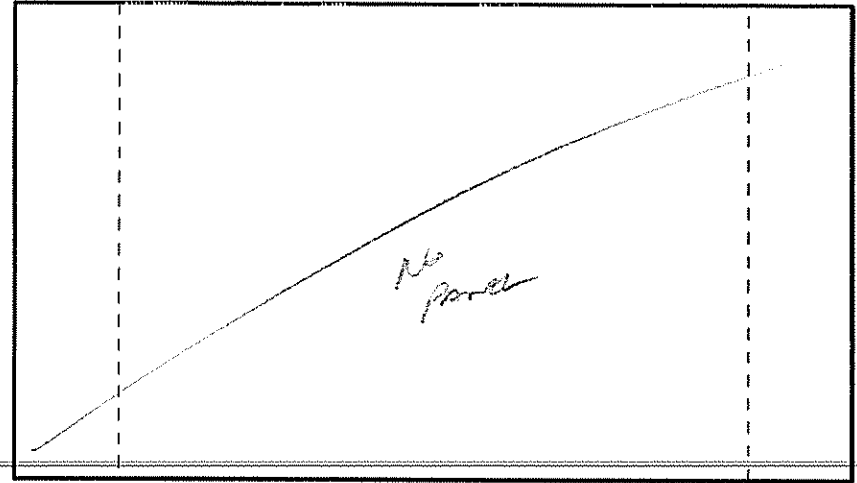

ACTION

(cut) WIDE ON INT. FREEZER & BUILT TUBS -
TRUCK-IN ON LAST TUB!

DIALOGUE

o/s Johnny (ADR)
IT'S THE LAST...

NOTES

(R2) - sc# (nov)

SCENE (189A)

PANEL

1/3

BG

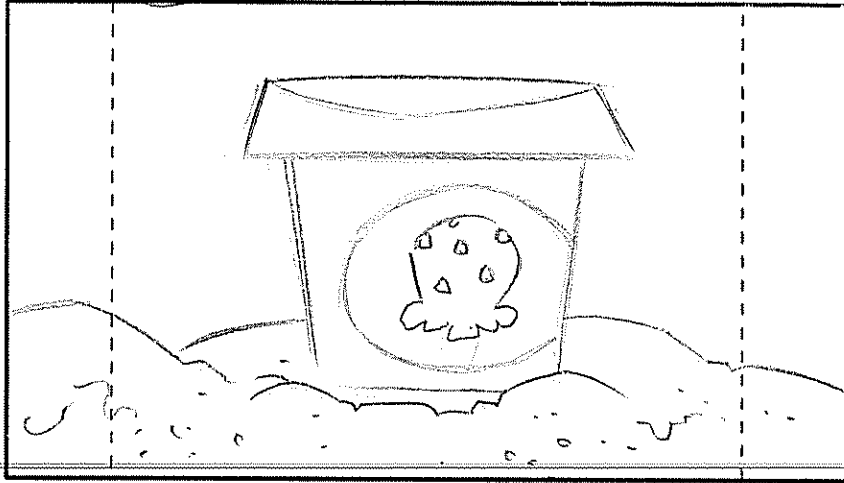

ACTION

SCENE

PANEL

2/3

BG

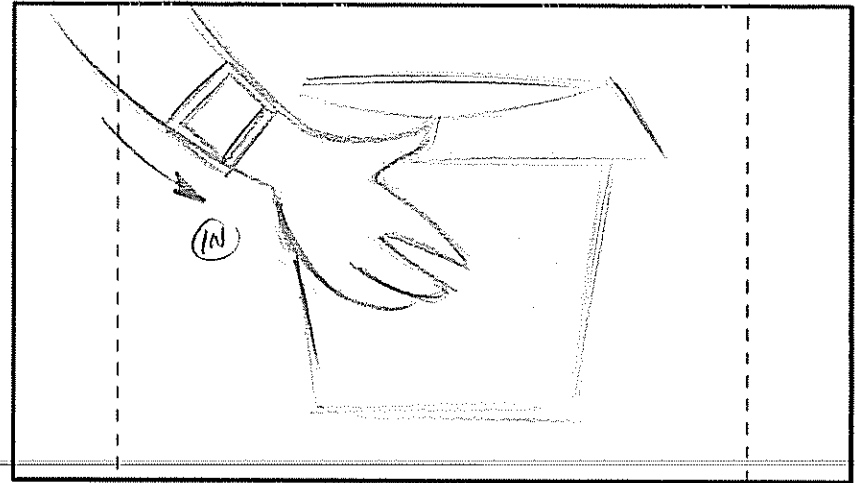

- Johnny's Hand IN

DIALOGUE

Johnny: (canta) (RDR)
... TUB!

NOTES

SCENE 189A cont'D PANEL

3/3 BG

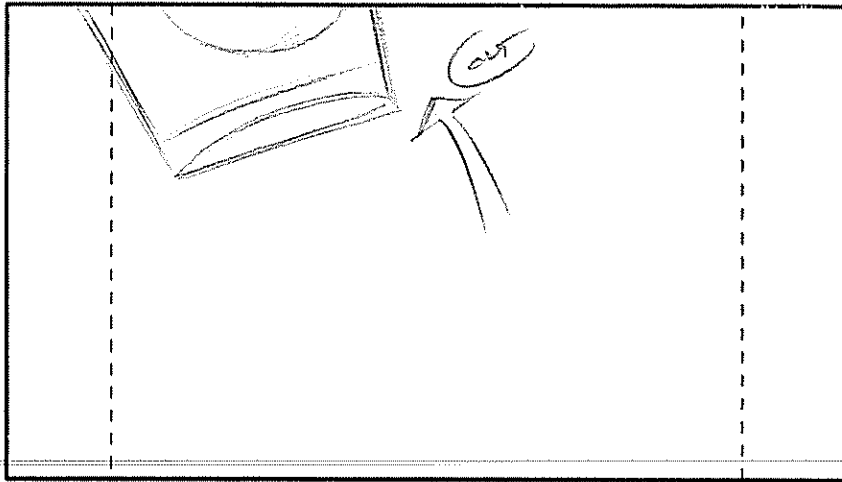

ACTION

- Hand & TUB out!

SCENE (190) PANEL

1/2 BG

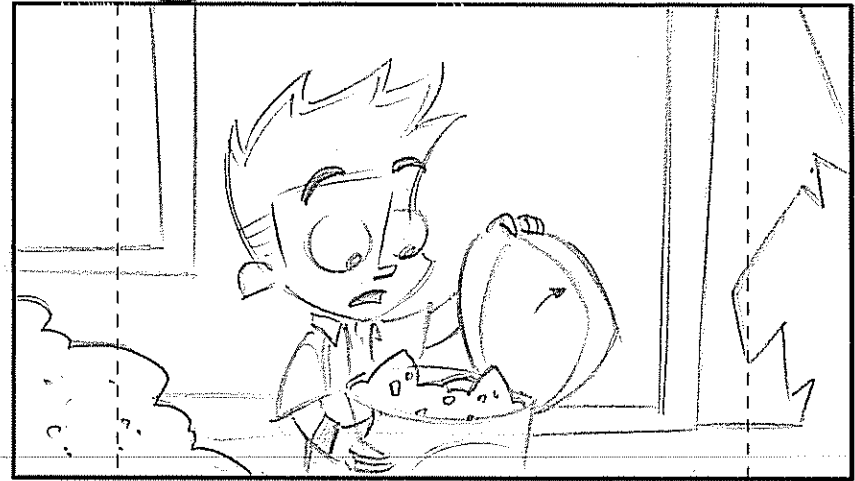

cut To Johnny opening LID OF TUB

DIALOGUE

Johnny: (AOR)
HE'S GOT TO BE IN
HERE!

NOTES

SCENE 190 CONT'D PANEL

2/2

BG



ACTION

- Johnny GOBBLES DOWN THE ICE CREAM WITH HIS HANDS.

SCENE 191 PANEL

1/1

BG

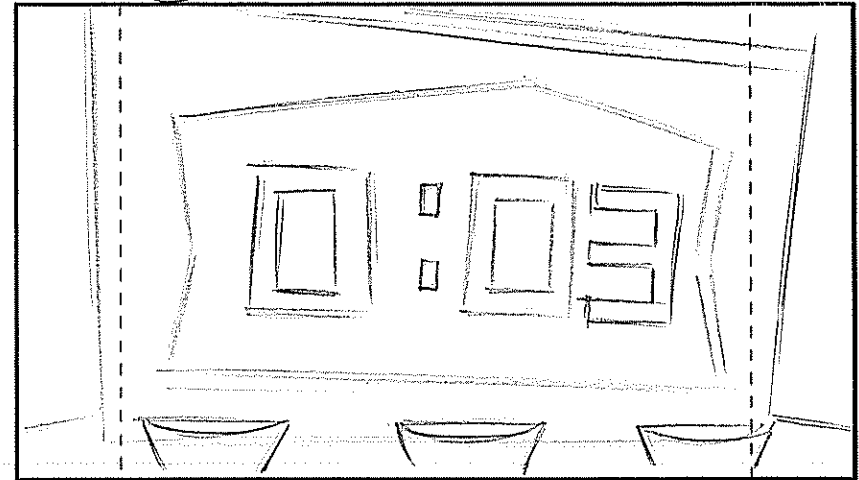

(CUT)

CLOSE UP DIGITAL CLOCK
- 3 SECONDS LEFT!

* (CLOCK CHANGES TO "3" SECS)

DIALOGUE

NOTES

SCENE (192)

PANEL

1/1 BG

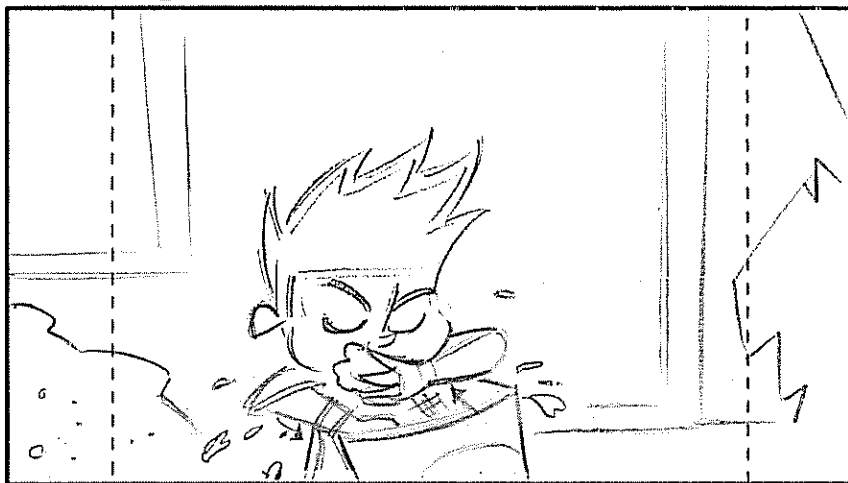

ACTION

(CUT) - Johnny GOBBLES DOWN THE ICE CREAM WITH HIS HANDS.
(SPEED UP FRAME RATE)

SCENE (193)

PANEL

1/1 BG

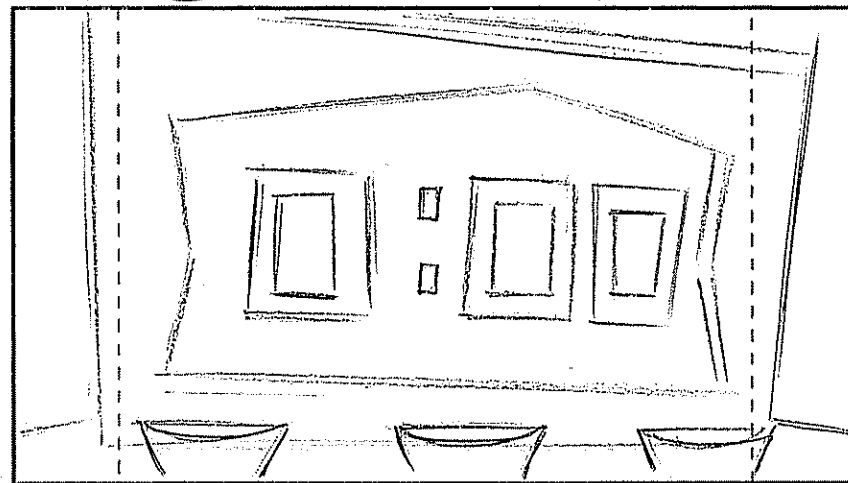

(CUT) CLOSE UP DIGITAL CLOCK
- ZERO SECONDS!
(*CLOCK CHANGED TO "0" SECS.!)

DIALOGUE

NOTES

(102) - NON SC!

ZOZP

(102) - NON PG.

SCENE (193A)

PANEL

BG

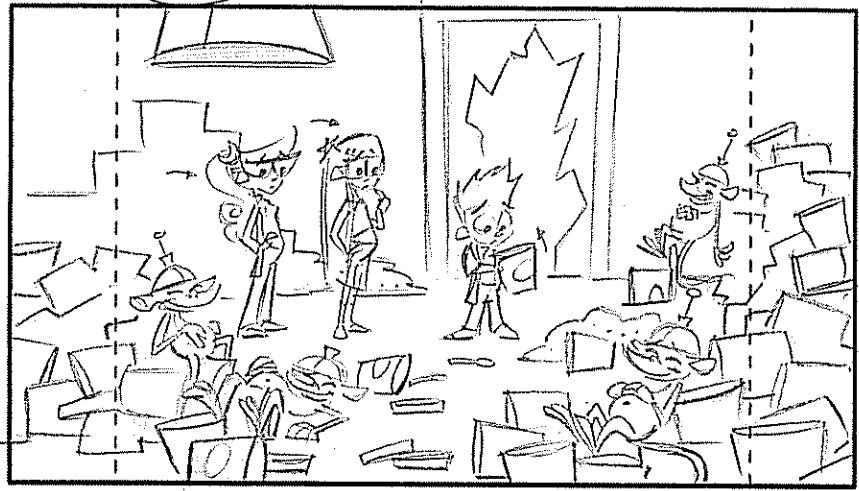

SCENE

PANEL

BG

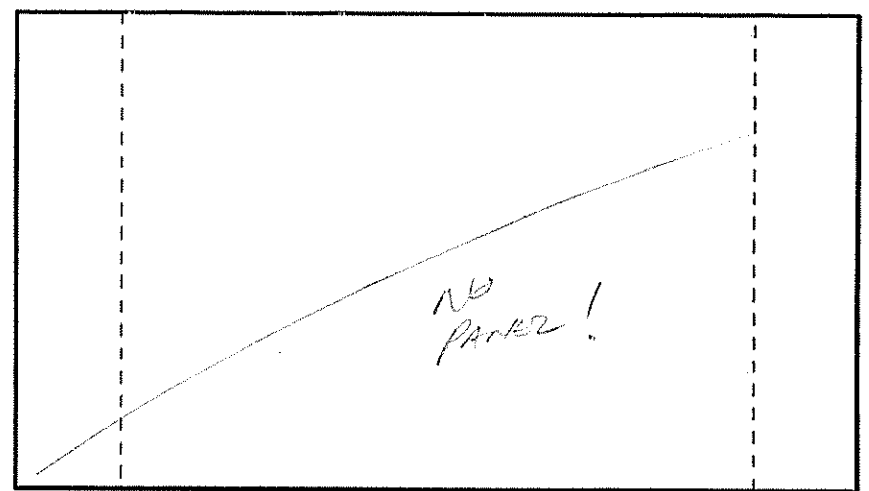

ACTION

(102)

WIDE on EVERYBODY &
EMPTY ICE CREAM TUBS.
(MART & SUSAN SETTLE)

DIALOGUE

(102) Johnny :
Dude!

NOTES



2008

(12) - non pg.
PAGE: 178B

(12) - VIS.
- PANELS -

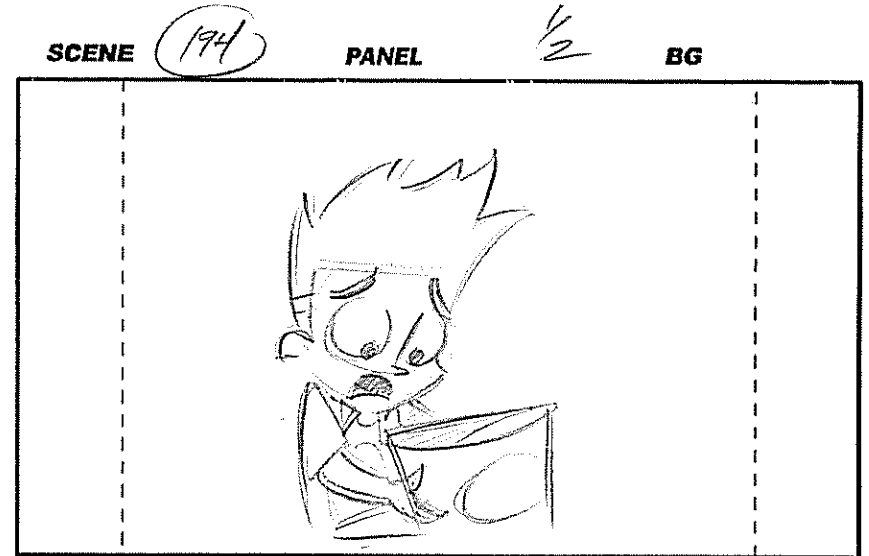
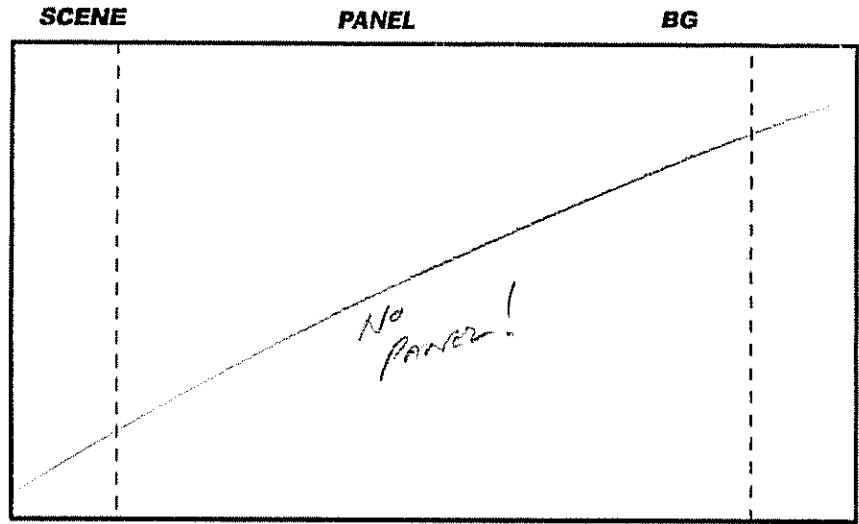

ACTION

(cut) To Johnny LEANING INTO TUB. (Johnny HAS BIG BELLY)

DIALOGUE

(102) Johnny: (CONT'D)
WHERE ARE YOU?

NOTES





202B

(R2) - VIS
- DIM

(R2) - VIS.

EPISODE: _____

PAGE: 179

SCENE 194 cont'd 2/2 BG

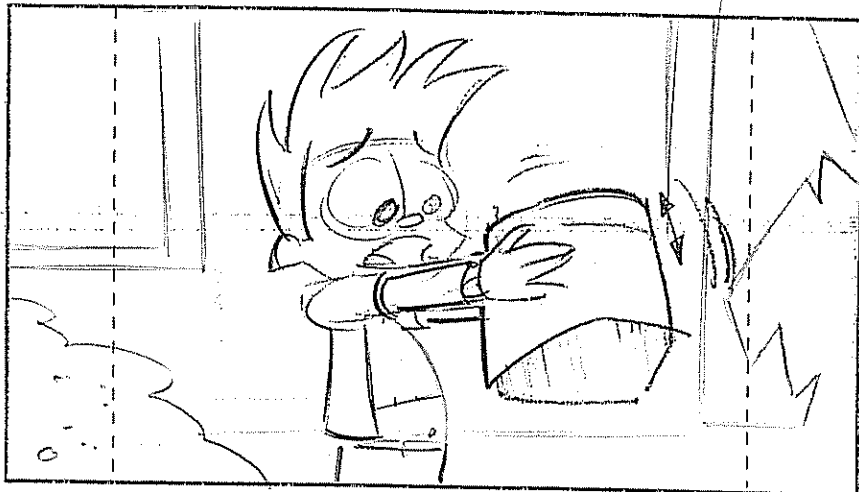

PLEASE
OUT!

ACTION

- JOHNNY SHAKES THE EMPTY CONTAINER -

DIALOGUE

102. JOHNNY
We musta ate HIM!

NOTES



RE - New Sc!

2028

RE - New Sc!

RE - New Sc!

PAGE: 177A

SCENE

194A

PANEL

1/2

BG

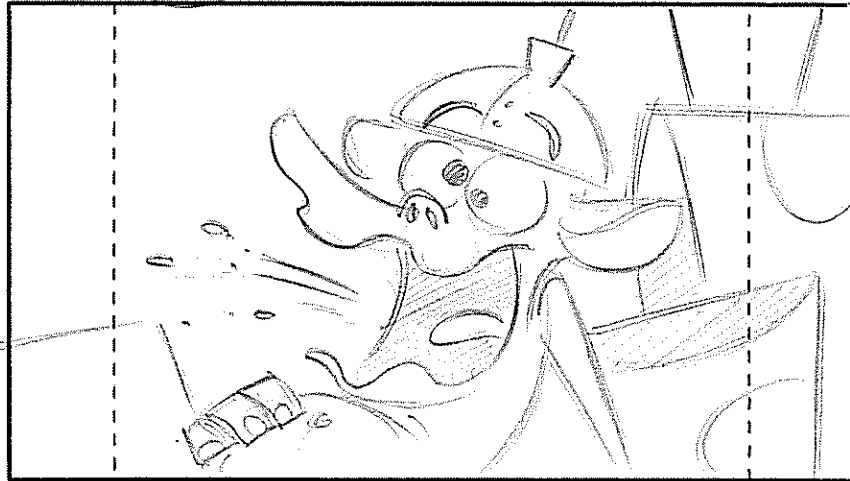

ACTION

CUT

To MONKEY BURP!

SCENE

194B

PANEL

1/2

BG

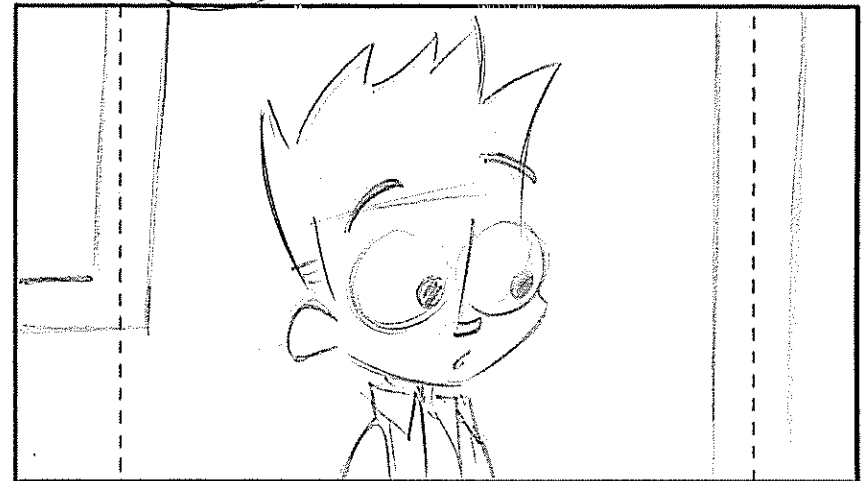

CUT

To Johnny.
(HEARD A BURP)

DIALOGUE

Monkey =
(BURP!)

NOTES

(re - vis. / mouse!

202B

(re - vis. / mouse!

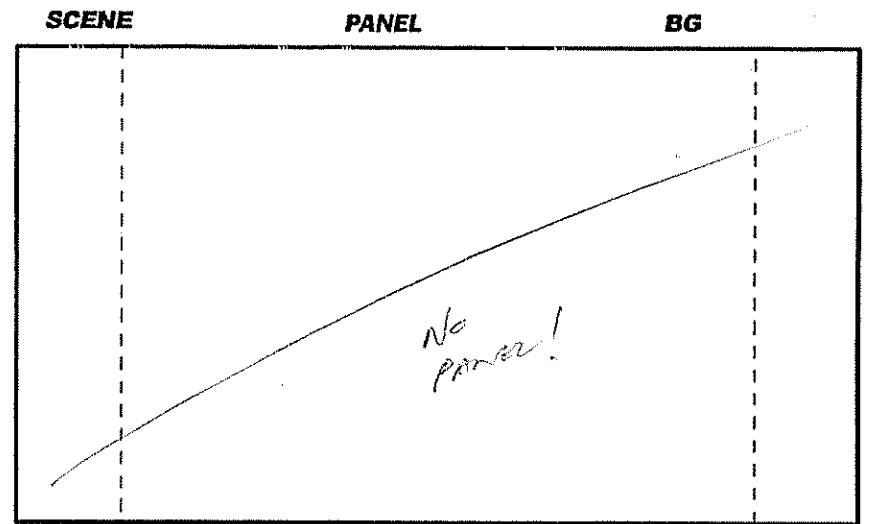
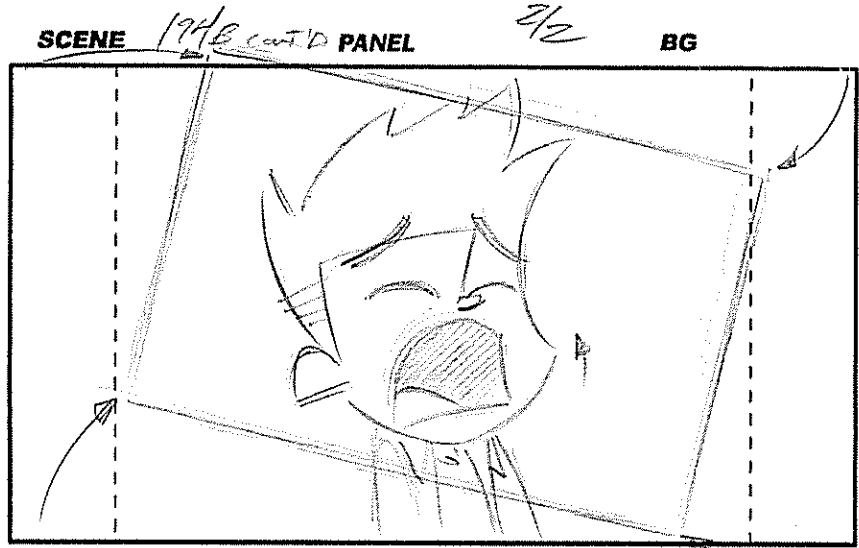

ACTION

Johnny SCREAMS (SNAP-SPIRAL TRK-IN!)

DIALOGUE

Johnny: (ADR) / LB
Neoooo!!!

NOTES

SCENE

195

PANEL

1/2

BG

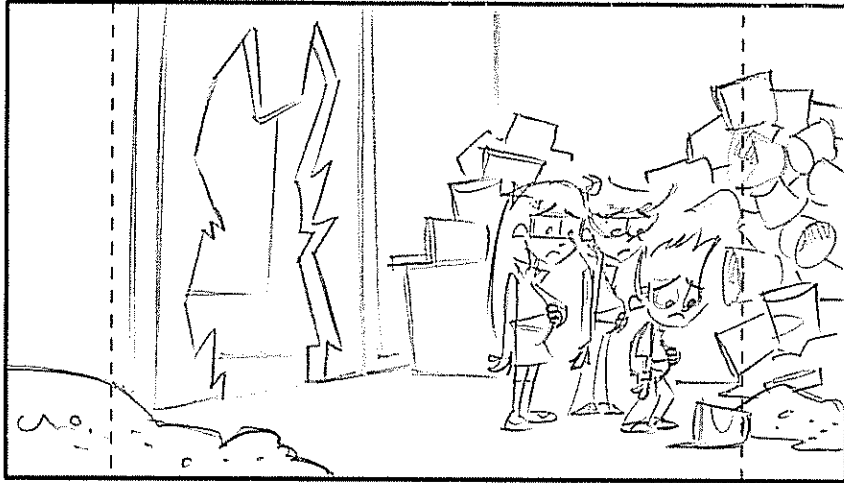

ACTION

TO SUSAN, MARY & JOHNNY ALL WITH FAT BELIES.

CUT
H.O.

DIALOGUE

NOTES

SCENE

PANEL

2/2

BG

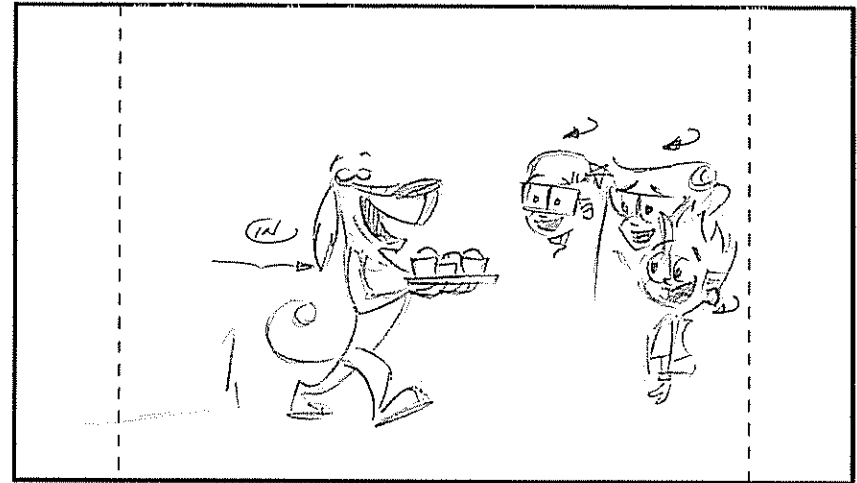

- DOREY ENTERS WITH A TRAY OF ICE CREAM.
- OTHERS TURN HEADS TO LOOK LT.

(12) DOREY:

THERE YA GUYS ARE! I GOT OUT RIGHT...



- VIS
- PANEL #'S
(KZ) - DIM

202B

EPISODE: _____ PAGE: 181

SCENE 196

1/1

BG



SCENE

PANEL

BG

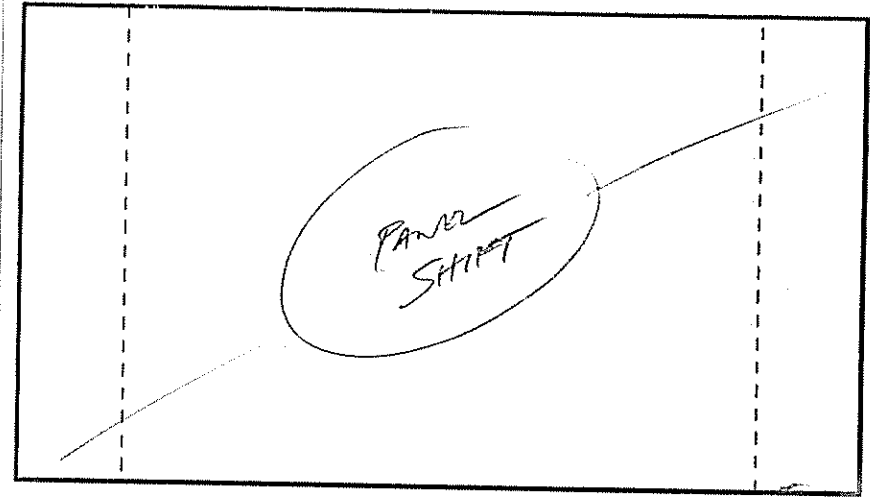

ACTION

(CZ)

CLOSE ON DUKE'S SETTINGS IN

DIALOGUE

(KZ) DUKE: (CONT'D)
... before I got sealed and PACKED.

NOTES



© 2006 Johnny Test Productions Inc. "Johnny Test" TM Warner Bros. Entertainment Inc. All Rights Reserved

collidoscope animation studios

(P2) - NEW SC!

202B

(P2) - NEW PS!

SCENE (196A)

PANEL 1/1

BG

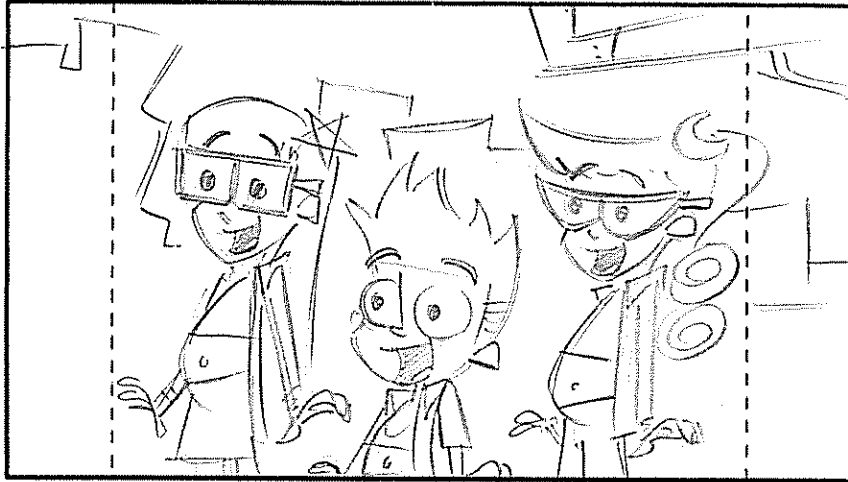

ACTION

(WR)

TO JOHNNY & SISTERS
REACT HAPPY!

SCENE (196B)

BG

- NEW SC

(P2) - VIS.

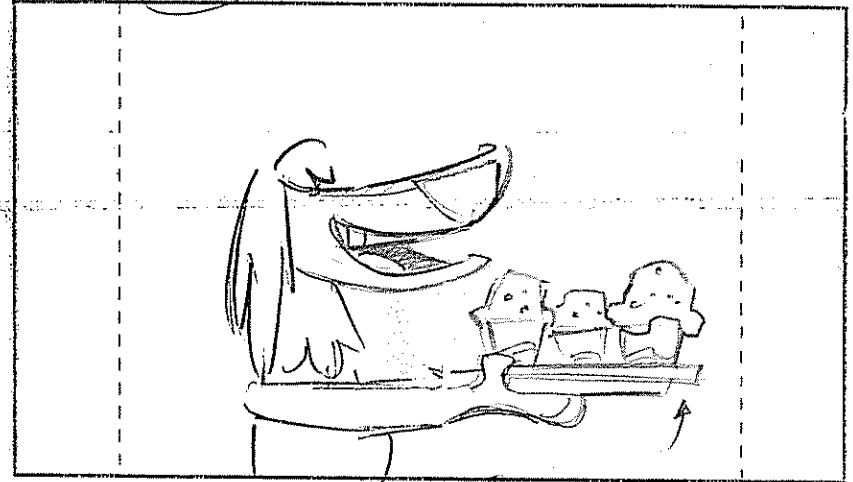

(WR)

BACK TO DUKY LISTENING
ICE CREAM SAMPLES.

DIALOGUE

(103) DUKY: (CONT'D)

AND I GOT FREE ICE CREAM
SAMPLES FOR EVERYONE!

NOTES

(12) - DIAL.

(12) - VIS. ACTION.

SCENE (197)

PANEL

1/2 BG

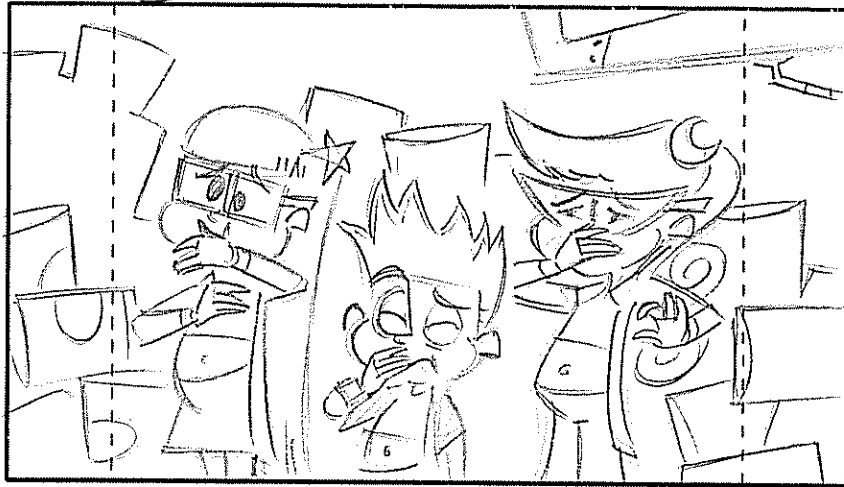

ACTION

(12) Johnny & THE TRANS LOOK U2.
(* BELTIES STILL BELATED)

SCENE

PANEL

2/2 BG

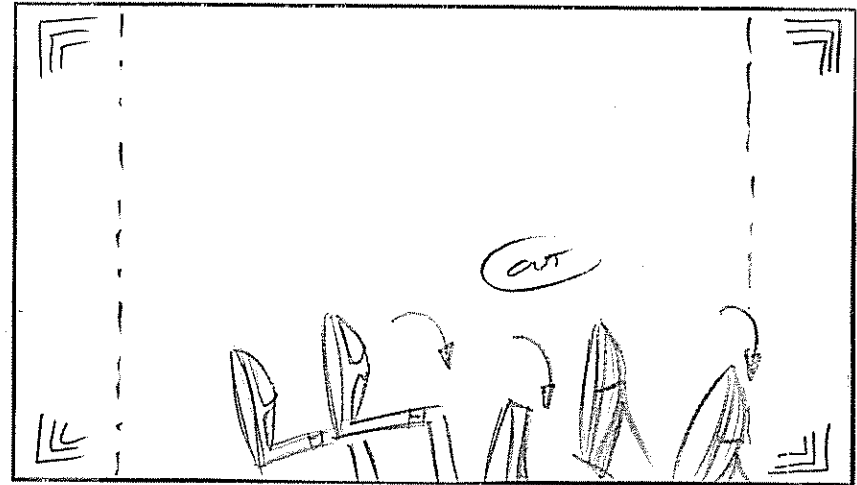

THAT ALL FALLS!
(CAMERA STABLE)

DIALOGUE

JOHNNY/SUSAN/MARY: (AD LIB)
(MORNS & GREENS) →

NOTES

(RE) - NOW SEE!

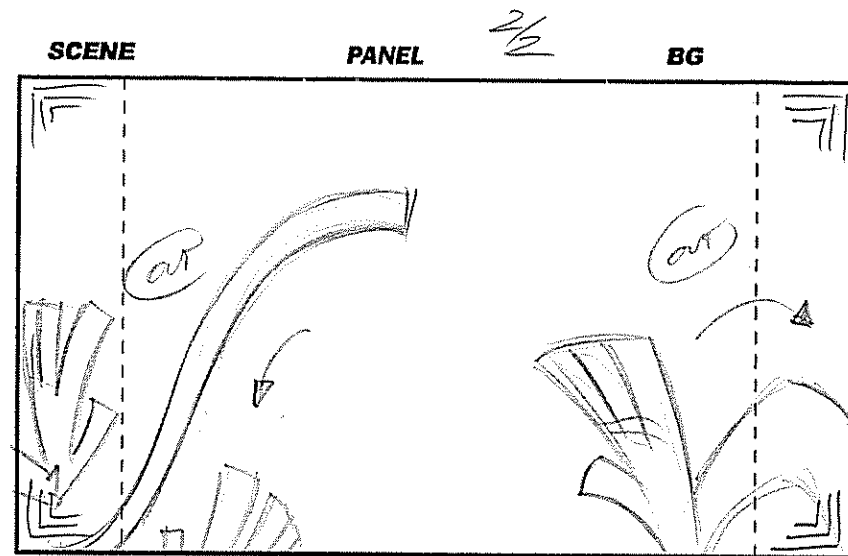
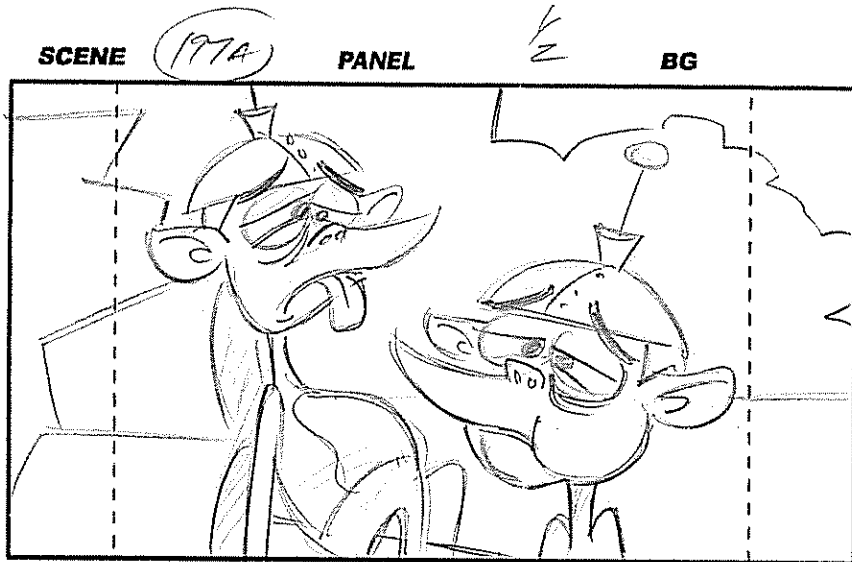

ACTION

(CUT) TO MONTAGE/S LOOKING ILL.

THEY ALSO FALL O/S!
(CAMERA SHAKE)

DIALOGUE

MONTAGE/S = (AD LIB)
(MONTAGE & GRANDS) →

NOTES

(12) - DIAL.

(12) - VIS.

SCENE (198)

PANEL

1/3 BG

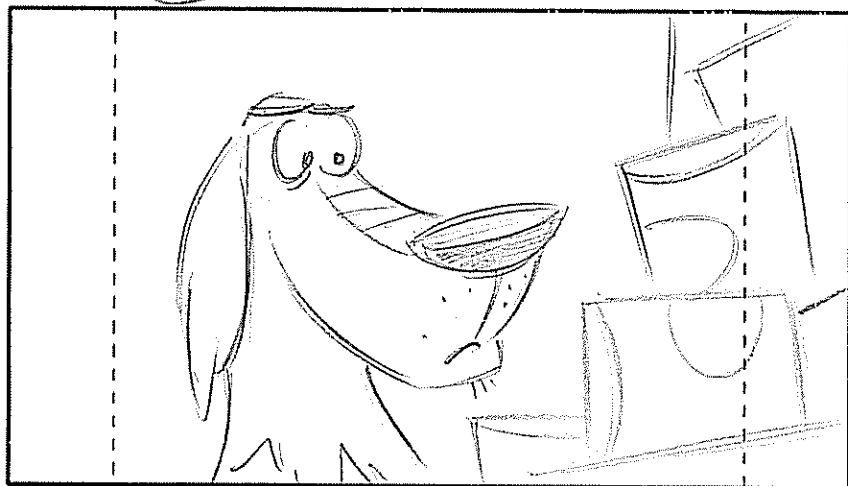

ACTION

(CUT) CLOSE ON SURPRISED DUFF.

SCENE

PANEL

2/3 BG

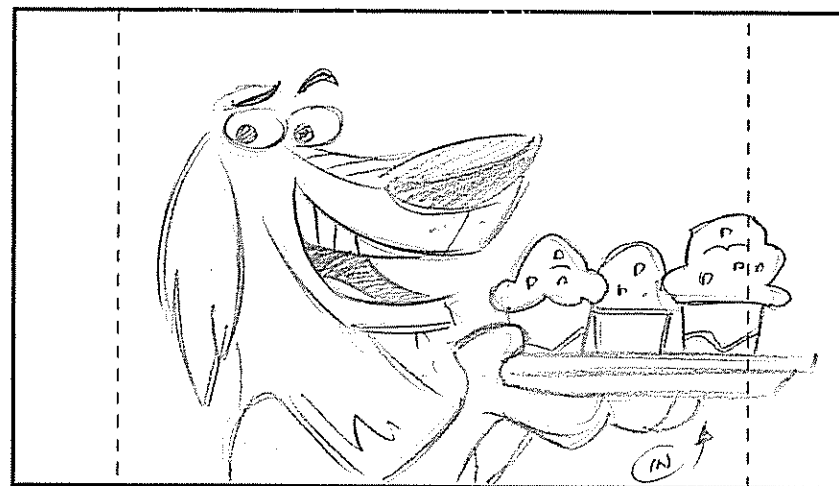

HE LIFTS TRAY OF ICE CREAM UP 1/2 IN.

DIALOGUE

Duff: (ADR)
HUH, I THOUGHT THEY LOVED MINT CHIP!

Duff: (ADR)
HUH, I THOUGHT THEY LOVED MINT CHIP! HEH HEH HEH HEH!

NOTES

SCENE 198 *CONF* PANEL

3/5 BG

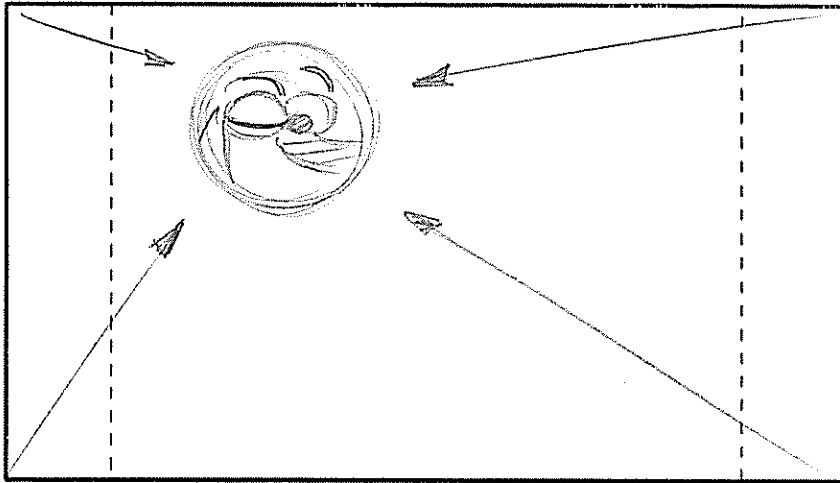

ACTION

IRIS OUT ON DAVEY'S WORK!

SCENE

PANEL

BG

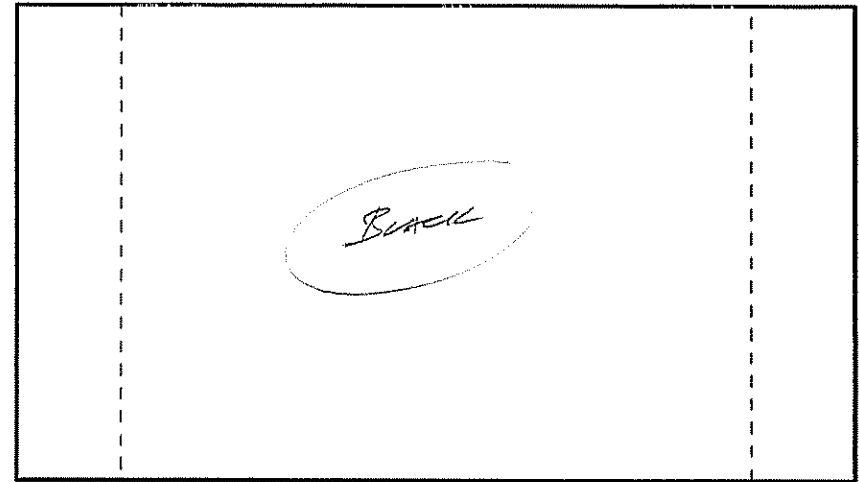

THE END!

DIALOGUE

NOTES